



Catalogo
2019

ATTREZZATURE PER
OFFICINE

PROFESSIONAL TOOLS

JBM[®]

INDICE PRODOTTI

VALIGETTE PORTAUTENSILI

5



VALIGETTE / CHIAVI / SET DI INSERTI / ALTA TENSIONE

UTENSILI MANUALI

31



CRICCHETO / CHIAVI LUNGHE SNODATE / PROLUNGA TELESCOPICA / CACCIAVITI / PIEGATUBI / TAGLIATUBI / PINZE / COLTELLI / ADATTATORI / KIT DI CHIAVI / CHIAVI STILLSON/ MARTELLI / SEGHE / LIME / PUNZONI / SCALPELLI / SCARPATE / RIVETTATRICI / CHIAVI A CROCE

MOBILI DA OFFICINA

57



CARRELLI CON ATTREZZATURE / ARMADI / MODULI PER CARRELLO / PANNELLO APPENDI ATTREZZI / GANCI DA PARETE / TAVOLO DA LAVORO / INCUDINI / MORSE DA BANCO / CASSETTE PER UTENSILI / CARRELLI / CAVALLETTI / SERBATOI / ACCESSORI

ILLUMINAZIONE

75



TORCIA TASCABILE / LAMPADINE PORTATILI / LUCI LAMPEGGIANTI / FANALI DA LAVORO / LAMPADINE PER AUTO

UTENSILI PNEUMATICI

92



AVVITATORI PNEUMATICI / UTENSILI AD ARIA COMPRESSA / PISTOLE SOFFIAGGIO ARIA / CRICCHETTI / SEGHE / SMERIGLIATRICE / TRAPANI / LEVIGATRICE ORBITALE / KIT LUCIDATRICE / VALIGETTE AVVITATORI + CRICCHETO

BUSSOLE PNEUMATICHE

107



BUSSOLE PNEUMATICHE / INSERTI PNEUMATICI / ADATTATORI / PROLUNGHE PNEUMATICHE / BUSSOLE SINGOLE / BUSSOLE GRANDI PER MEZZI PESANTI

CARROZZERIA

116



VENTOSE / MORSETTI / ACCESSORI / MATERIALE DI CONSUMO / PISTOLE PER SILICONE / LEVE

UTENSILI

127



FILTRI E FRENI / DISTRIBUZIONE / INIEZIONE / CANDELETTE / ESTRATTORI / SCARICO / STRUMENTI DINAMOMETRICI / MISURAZIONE / STRUMENTI SPECIALI / ALTRI UTENSILI

KIT ATTREZZI

166



KITS DI DISTRIBUZIONE / ATTREZZO DI REGOLAZIONE ALBERO / KIT TENDINCINGHIA / ALTRI STRUMENTI

ACCESSORI LUBRIFICANTI

191



VASCA DI RACCOLTA / POMPE MANUALI PER ESTRAZIONE / PISTOLA ASPIRAZIONE / INGRASSATORE PNEUMATICO / SISTEMA DI RIEMPIMENTO DELLA POMPA DI TRANSMISSIONE / POMPA MANUALE PER ASPIRAZIONE / SERBATOI DI STOCCAGGIO FUSTI OLIO

UTENSILI IDRAULICI

198

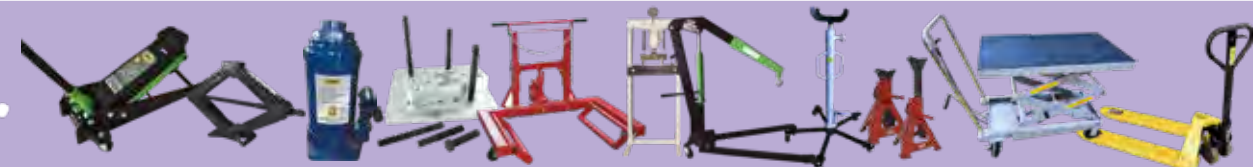

SOLLEVATORI A BOTTIGLIA / MARTINETTI OLEOPNEUMATICO / MARTINETTI IDRAULICO / PORTARUOTE / PRESSE / PARANCO / SUPPORTI PER MOTORI / TAVOLO IDRAULICO PER MOTOCICLETTE / SOLLEVATORE MOTO

UTENSILI ELETTRICI

207



CARICA BATTERIA / TRAPANO VERTICALE / CAVI DI AVVIAMENTO / TESTER PER BATTERIA / ASPIRATORI / PULITRICI DI PEZZI / MOLA ELETTRICA / COMPRESSORI

ACCESSORI

216



AVVOLGITORI / ACCESSORI PER OFFICINA / ORGANIZER / SICUREZZA / KIT DI EMERGENZA / SENSORI DI PARCHEGGIO / AUTOVEICOLI / SPAZZOLE PER TERGICRISTALLO / CONTRAPESSI / VALVOLE TPMS / VALVOLE PER PNEUMATICI / ASTUCCIO / TUBI FLESSIBILI

CONSUMABILI

242



ANELLI / SPINE / CHAVETAS / VITI E DADI / RIVETTI / RONDELLE / CLAMPS / O-RINGS / TUBI TERMORETRATTILI / GRASERS / FUSIBILI / MORSETTI / CLIPS DI PLASTICA

ABBIGLIAMENTO

260



GILET / GIACCA

PROMOZIONALE

262



ESPOSITORE DE ATTREZZATURE / PROMOZIONALE

JBM®**JBM, LA EMPRESA**

JBM é un'impresa dedicata alla distribuzione di **strumenti professionali**.

Siamo un **marchio líder** spagnolo finalizzato al settore industriale e automobilistico. JBM dispone anche di un settore dedicato esclusivamente alla fornitura dell'aftermarket, equipaggiando direttamente alcuni produttori.

Offrendo una gamma completa di **più di 5000 prodotti**, abbiamo più di **30 anni di esperienza** e esportiamo i nostri prodotti in più di **35 stati in tutto il mondo**.

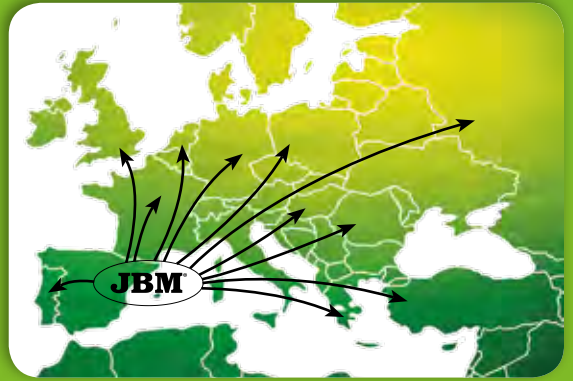

**FAI TUOI ORDINI
24H.**

www.jbmcamp.com



**+2.500
PRODOTTI
IN CATALOGO**

**+250
NUOVO
PRODOTTI**

**JBM®**

**NUMERO 1
IN QUALITÀ
E PREZZO**

ATTENZIONE AL CLIENTE

+34 972 24 55 33

+34 972 40 57 21



jbm@jbmcamp.com

**+10.000
EUROPALLETS
IN AZIONE**

**ROTAZIONE
ANNUALE
x4**



**NAZIONALE E
INTERNAZIONALE**



**VUOI AVERE TUTTO IL CATALOGO JBM
NELLA TUA TASCA ?**

Scarica la nostra applicazione e mantieniti informato in ogni momento sulle ultime novità e promozioni JBM.

Scopri tutte le applicazioni e funzioni dell'APP di JBM in:

 **App Store**

 **Google play**





VALIGETTE PORTAUTENSILI

| | |
|--|----|
| VALIGETTE PORTAUTENSILI | 6 |
| SET / VALIGETTA CON BUSSOLE | 19 |
| VALIGETTE DI INSERTI | 21 |
| STRUMENTI IN POLLICI | 23 |
| VALIGETTE PORTAUTENSILI IN ALLUMINIO | 24 |
| VALIGETTA CON BUSSOLE + CRICCHETTO | 26 |
| SET DI INSERTI | 26 |
| ADATTATORI | 28 |
| STRUMENTI AD ALTA TENSIONE | 29 |

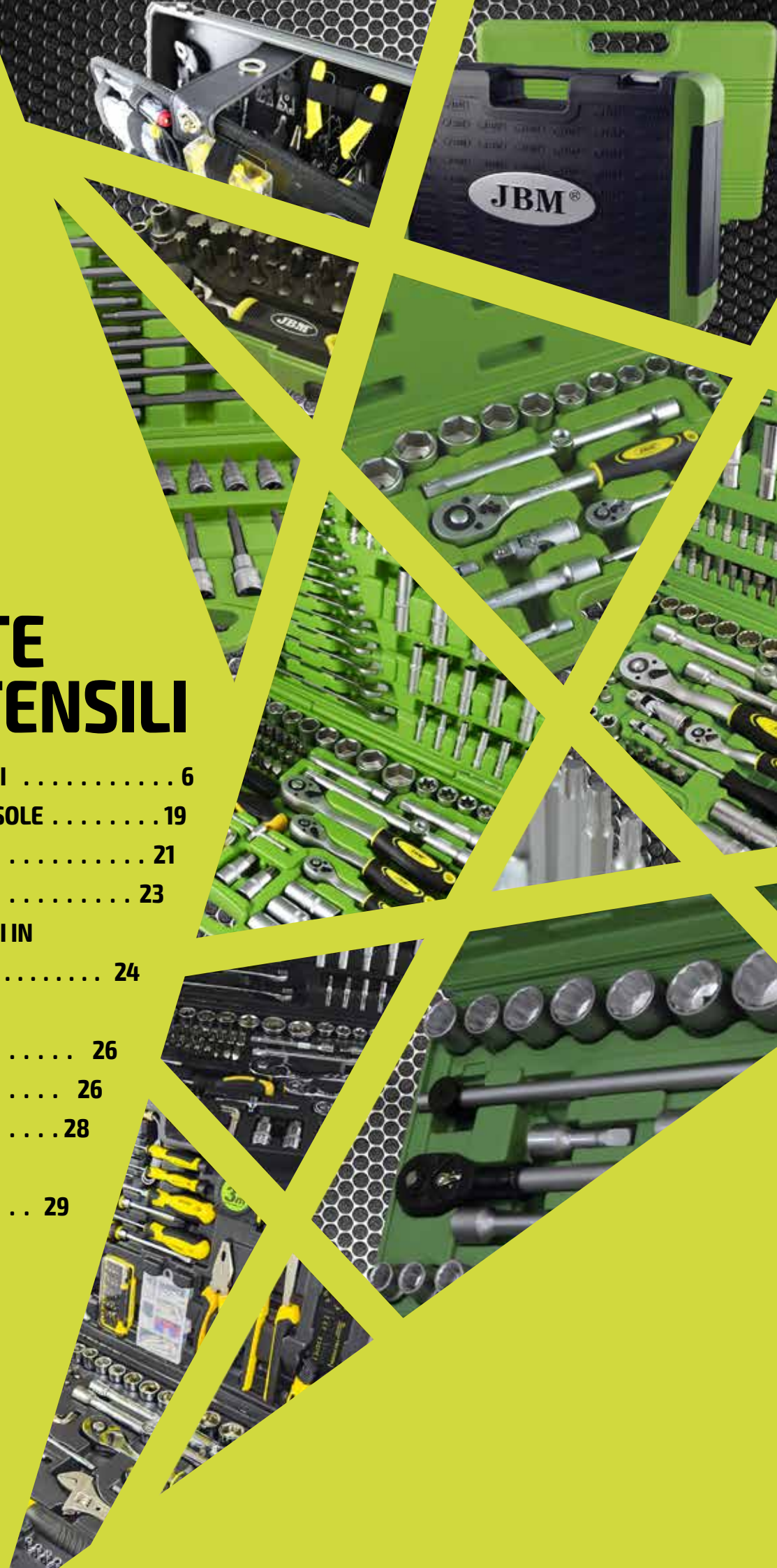

VALIGETTA PORTAUTENSILI CON 216 PEZZI BUSSOLE ESAGONALI



**216
PCS**



FINITURA SATINATA

| | | | |
|----------------|-------|----|----|
| 50895 | 10,75 | 2 | 48 |
| 145,50€ | Kg | 11 | |

FINITURA CROMATA

| | | | |
|----------------|-------|----|----|
| 52840 | 11,01 | 2 | 48 |
| 163,00€ | Kg | 11 | |

➤ **RICAMBI DISPONIBILI**
CONSULTA IL NOSTRO CATALOGO

1/2"



1/4"

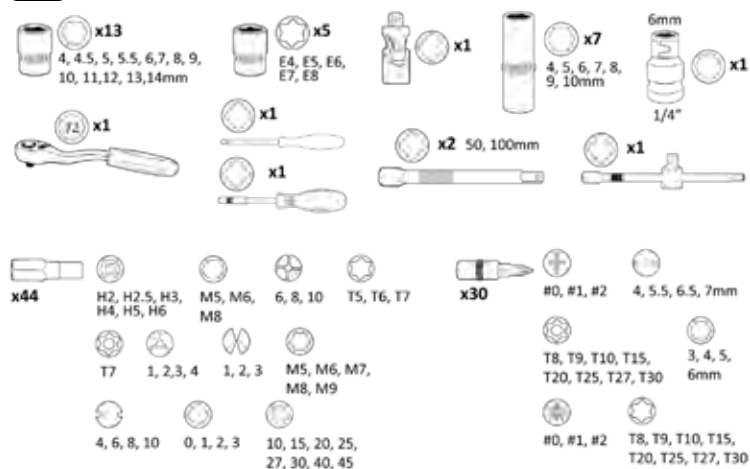

3/8"

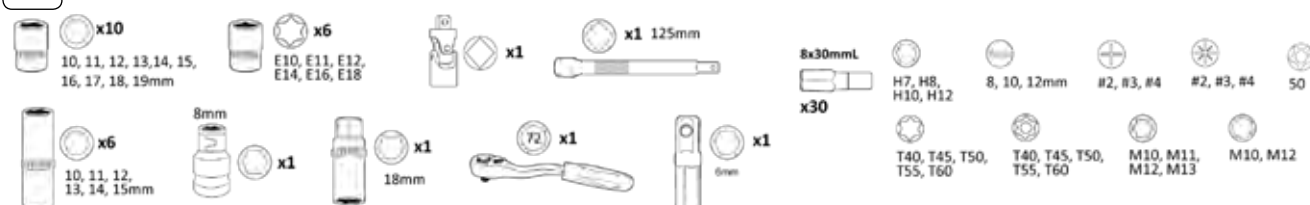

VALIGETTA PORTAUTENSILI CON 113 PEZZI BUSSOLE POLIGONALI



**113
PCS**



FINITURA SATINATA

| | | | |
|---------------|------|---|-----|
| 50791 | 6,55 | 3 | 108 |
| 81,50€ | | | |

FINITURA CROMATA

| | | | |
|---------------|------|---|-----|
| 52979 | 7,06 | 3 | 108 |
| 87,00€ | | | |

➤ **RICAMBI DISPONIBILI**
CONSULTA IL NOSTRO CATALOGO

1/2"

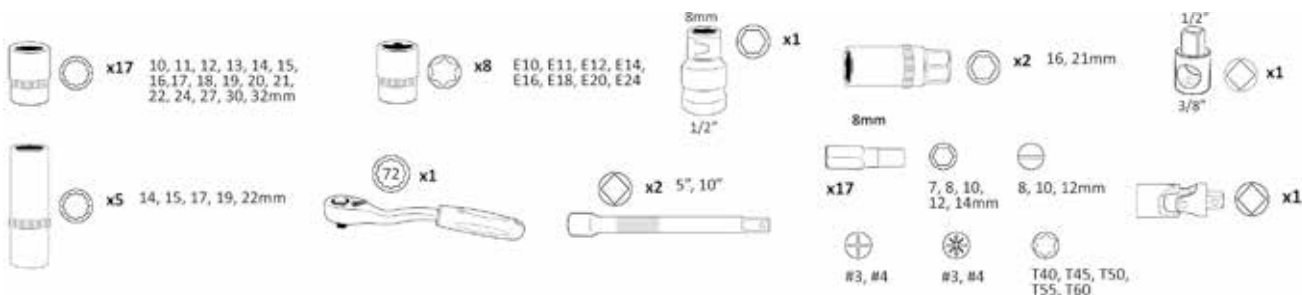

1/4"

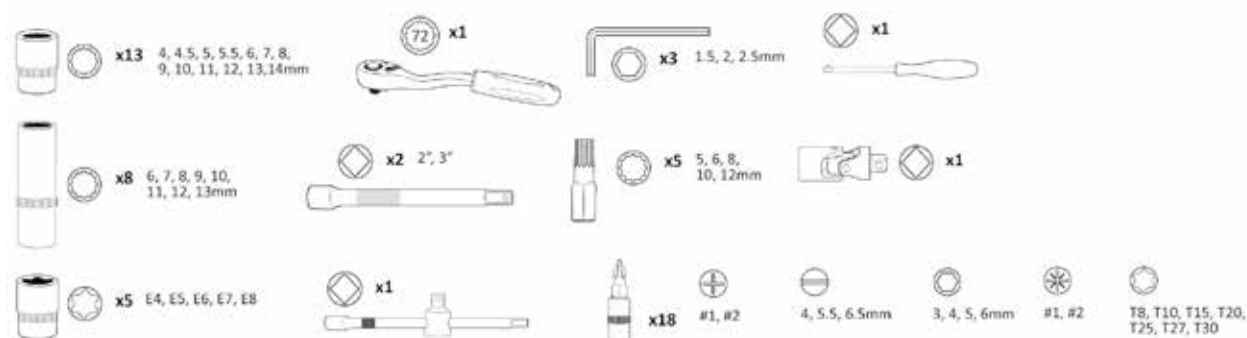

VALIGETTA PORTAUTENSILI CON 108 PEZZI BUSSOLE ESAGONALI



**108
PCS**



FINITURA SATINATA

| | | | |
|---------------|------|---|-----|
| 50521 | 6,58 | 3 | 108 |
| 76,00€ | | | |

FINITURA CROMATA

| | | | |
|---------------|------|---|-----|
| 52978 | 7,00 | 3 | 108 |
| 86,00€ | | | |

► **RICAMBI DISPONIBILI**
CONSULTA IL NOSTRO CATALOGO

1/2"

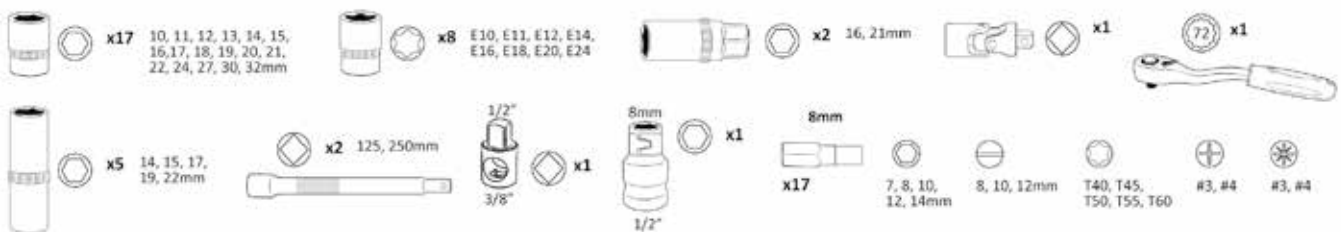

1/4"

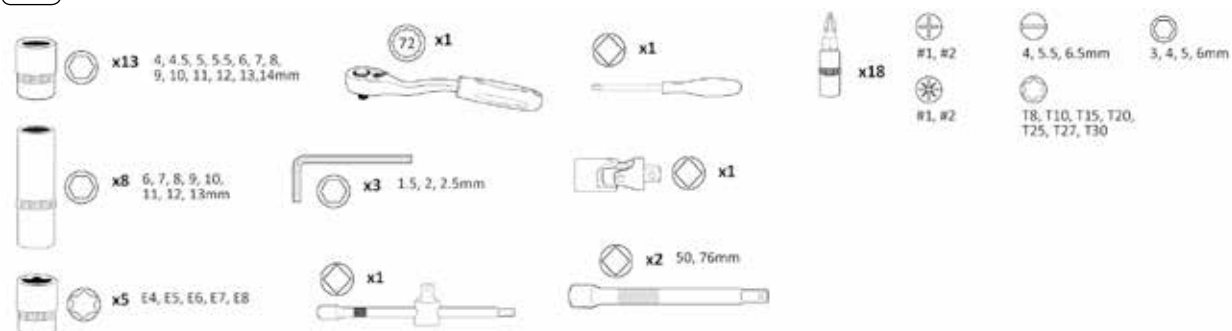

**VALIGETTA PORTAUTENSILI CON 94 PEZZI
BUSSOLE ESAGONALI**



**94
PCS**



FINITURA SATINATA

| | | | |
|---------------|------|---|-----|
| 50437 | 6,00 | 3 | 108 |
| 70,50€ | | | |

FINITURA CROMATA

| | | | |
|---------------|------|---|-----|
| 53011 | 6,47 | 3 | 108 |
| 77,00€ | | | |

➤ **RICAMBI DISPONIBILI**
CONSULTA IL NOSTRO CATALOGO

1/2"

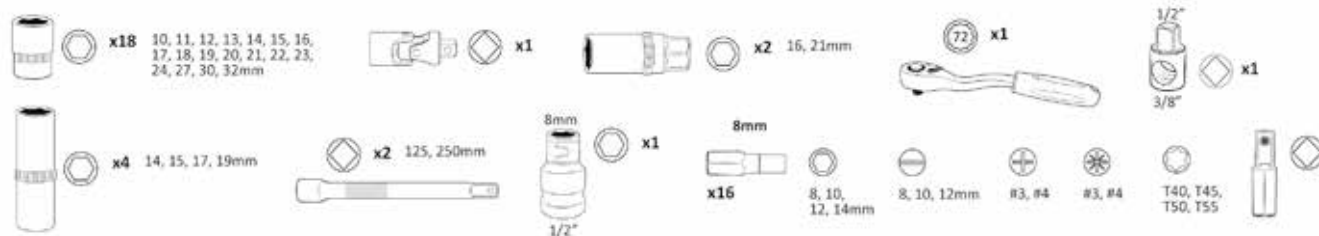

1/4"

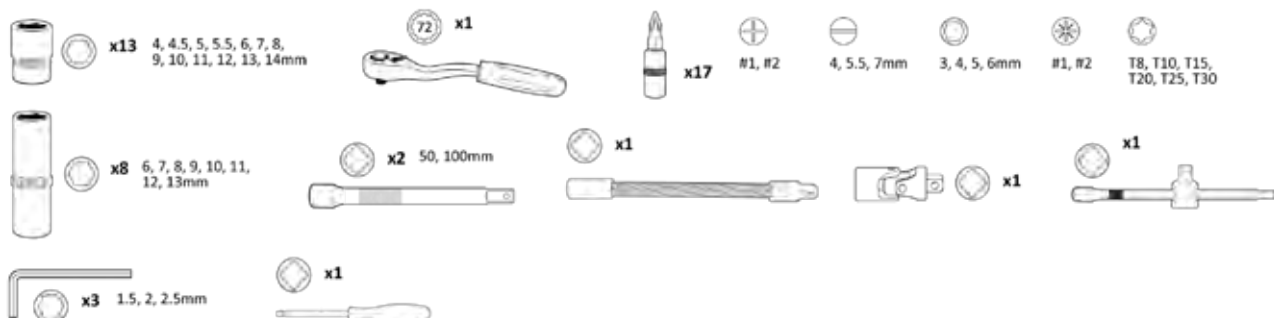

**VALIGETTA PORTAUTENSILI CON 74 PEZZI
BUSSOLE POLIGONALI**



**74
PCS**



FINITURA SATINATA

| | | | |
|---------------|------|---|-----|
| 51316 | 4,62 | 3 | 108 |
| 65,00€ | | | |

FINITURA CROMATA

| | | | |
|---------------|------|---|-----|
| 53074 | 5,09 | 3 | 108 |
| 76,00€ | | | |

**RICAMBI DISPONIBILI
CONSULTA IL NOSTRO CATALOGO**

1/2"



1/4"

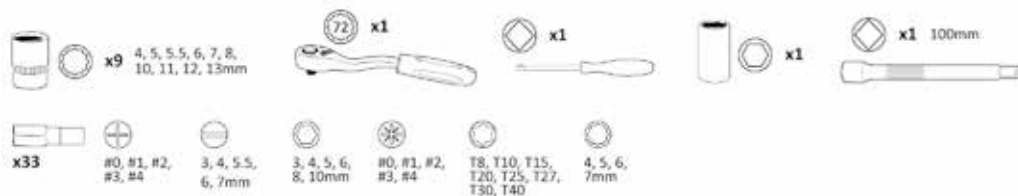

VALIGETTA PORTAUTENSILI 3/8" CON 59 PEZZI BUSSOLE POLIGONALI



**59
PCS**



FINITURA SATINATA

| | | | |
|---------------|------|----|-----|
| 51820 | 2,55 | 10 | 180 |
| 51,00€ | | | |

FINITURA CROMATA

| | | | |
|---------------|------|----|-----|
| 53075 | 2,57 | 10 | 180 |
| 54,00€ | | | |

3/8"

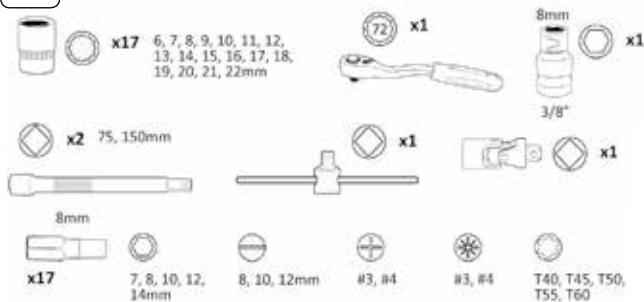

1/4"



➤ **RICAMBI DISPONIBILI**
CONSULTA IL NOSTRO CATALOGO

VALIGETTA PORTAUTENSILI 59 PEZZI 3/8" BUSSOLE ESAGONALI



**59
PCS**

➤ **RICAMBI DISPONIBILI**
CONSULTA IL NOSTRO CATALOGO

FINITURA SATINATA

| | | | |
|---------------|------|----|-----|
| 51819 | 2,55 | 10 | 180 |
| 51,00€ | | | |

FINITURA CROMATA

| | | | |
|---------------|------|----|-----|
| 53219 | 2,60 | 10 | 180 |
| 54,00€ | | | |



3/8"

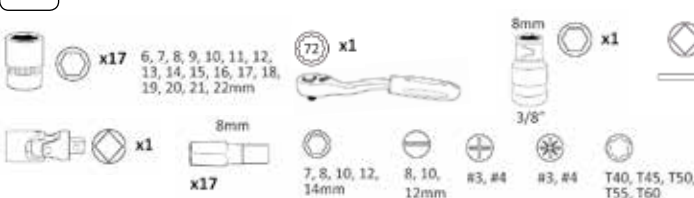

1/4"

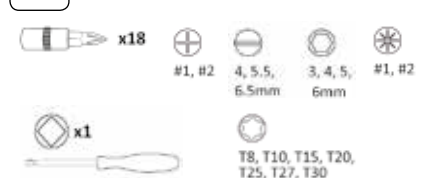

VALIGETTA PORTAUTENSILI 56 PEZZI

56
PCS

FINITURA SATINATA

| | | | |
|---------------|------|----|-----|
| 50566 | 1,19 | 10 | 240 |
| 33,00€ | Kg | | |

FINITURA CROMATA

| | | | |
|---------------|------|----|-----|
| 53101 | 1,26 | 10 | 270 |
| 36,50€ | Kg | | |



RICAMBI DISPONIBILI
CONSULTA IL NOSTRO CATALOGO

1/4"

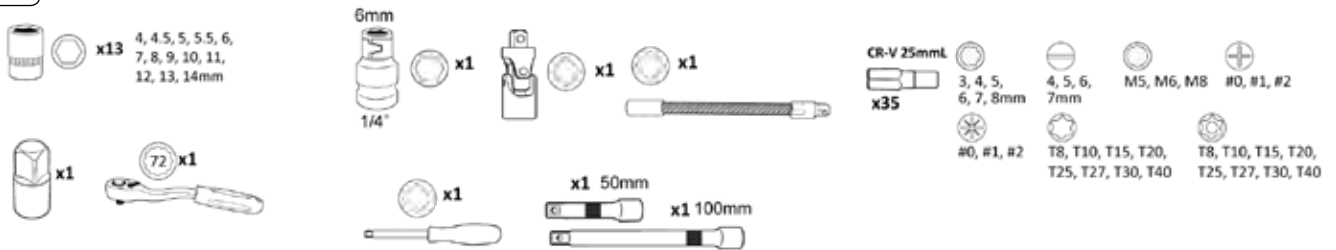

VALIGETTA PORTAUTENSILI CON 56 PEZZI

56
PCS

FINITURA SATINATA

| | | | |
|---------------|------|----|-----|
| 51892 | 1,13 | 10 | 240 |
| 33,00€ | Kg | | |

FINITURA CROMATA

| | | | |
|---------------|------|----|-----|
| 53102 | 1,28 | 10 | 270 |
| 36,50€ | Kg | | |



RICAMBI DISPONIBILI
CONSULTA IL NOSTRO CATALOGO

1/4"

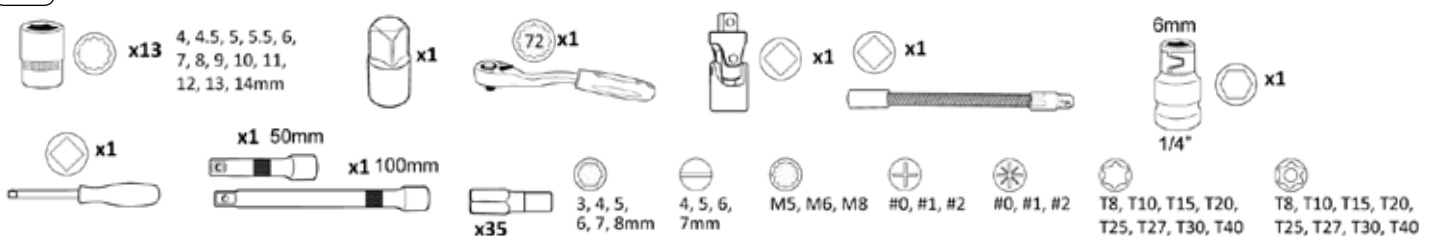

VALIGETTA PORTAUTENSILI 41 PEZZI BUSSOLE ESAGONALI



| | | | |
|---------------|-----|---|----|
| 52713 | 6,3 | 4 | 96 |
| 75,00€ | | | |

1/2"



VALIGETTE PORTAUTENSILI CON 21 PEZZI BUSSOLE DE 1/2"

| | | | |
|---------------|-----|---|-----|
| 52721 | 3,2 | 4 | 108 |
| 53,00€ | | | |



1/2"

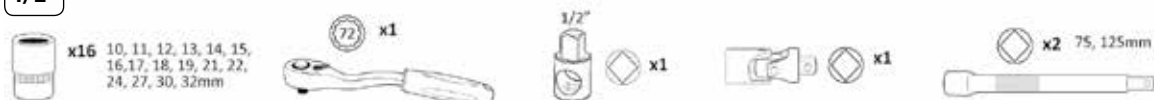

| | | | |
|---------------|-----|---|----|
| 52723 | 3,2 | 4 | 96 |
| 46,50€ | | | |



**VALIGETTA PORTAUTENSILI 72 PEZZI
BUSSOLE ESAGONALI**



**72
PCS**



FINITURA SATINATA

| | | | |
|---------------|------|----|----|
| 51818 | 7,25 | 3 | 63 |
| 86,00€ | Kg | 1f | 1f |

FINITURA CROMATA

| | | | |
|---------------|-----|----|----|
| 53106 | 7,2 | 3 | 60 |
| 98,00€ | Kg | 1f | 1f |

➤ **RICAMBI DISPONIBILI**
CONSULTA IL NOSTRO CATALOGO

1/2"

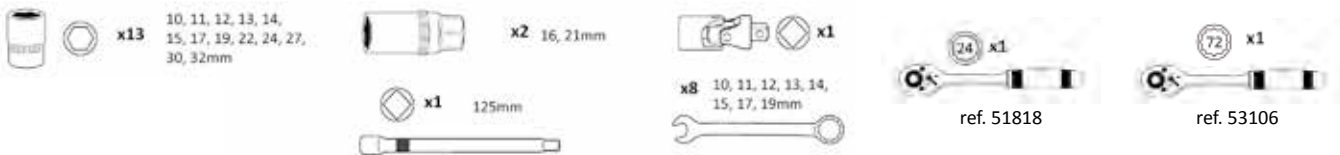

1/4"

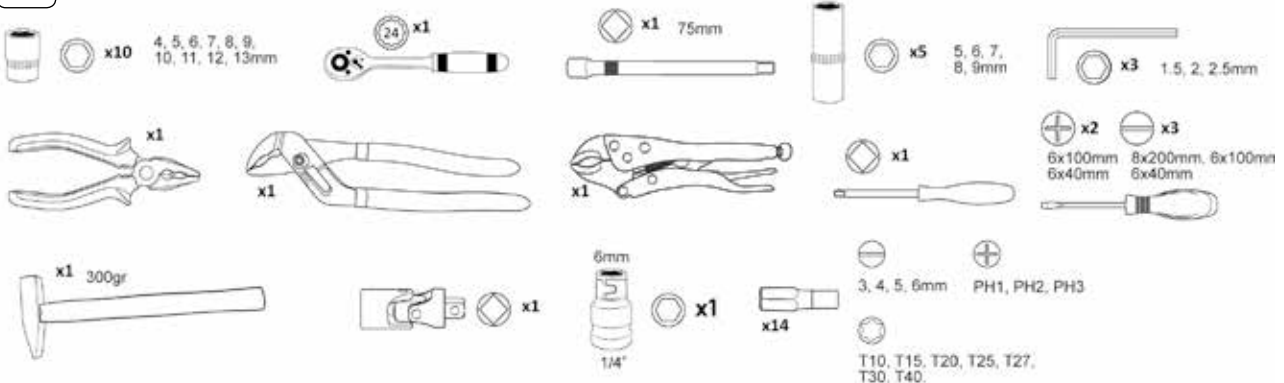

VALIGETTA PORTAUTENSILI CON 82 PEZZI BUSSOLE ESAGONALI

| | | | |
|---------------|------|-----|----|
| 52712 | 6,08 | 3 | 96 |
| 92,50€ | Kg | 1f1 | |



1/2"

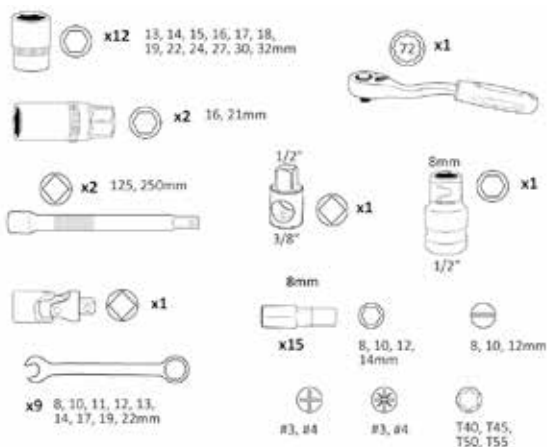

1/4"



➤ **RICAMBI DISPONIBILI**
CONSULTA IL NOSTRO CATALOGO

VALIGETTA PLASTICA PORTAUTENSILI 3/4"

CON 22 PEZZI BUSSOLE ESAGONALI

| | | | |
|----------------|------|-----|----|
| 53397 | 14,2 | 1 | 40 |
| 163,00€ | Kg | 1f1 | |



| | | | |
|----------------|------|-----|----|
| 53398 | 13,9 | 1 | 40 |
| 163,00€ | Kg | 1f1 | |

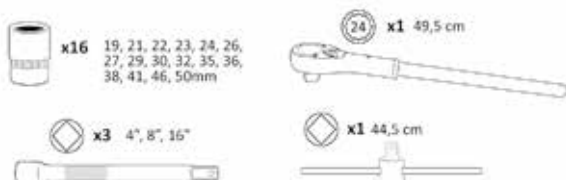

➤ **RICAMBI DISPONIBILI**
CONSULTA IL NOSTRO CATALOGO

VALIGETTA METALLICA PORTAUTENSILI 1" CON 22 PEZZI BUSSOLE ESAGONALI

| | | | |
|----------------|-------|---|----|
| 51616 | 43,45 | 1 | 24 |
| 361,00€ | Kg | | |



| | | | |
|----------------|------|---|----|
| 51855 | 41,1 | 1 | 24 |
| 361,00€ | Kg | | |

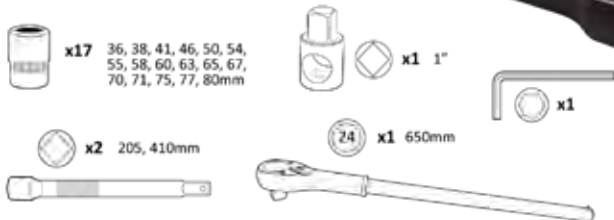

➤ **RICAMBI DISPONIBILI**
CONSULTA IL NOSTRO CATALOGO

VALIGETTA PORTAUTENSILI 39 PEZZI BUSSOLE ESAGONALI PROFILO BASSO

| | | | |
|----------------|------|---|-----|
| 52418 | 3,61 | 5 | 100 |
| 158,50€ | Kg | | |



1/4"



VALIGETTA CON 17 PEZZI CON BUSSOLE PER VITI PRIGIONIERE

| | | | |
|---------------|------|----|-----|
| 50623 | 0,63 | 10 | 320 |
| 54,00€ | Kg | | |



1/4"



OCCUPA UNO SPAZIO MINIMO

2,5cm



VALIGETTA CON 15 PEZZI CON BUSSOLE PER VITI PRIGIONIERE

| | | | |
|---------------|------|----|-----|
| 51617 | 1,06 | 18 | 320 |
| 60,50€ | Kg | ff | |



OCCUPA UNO SPAZIO MINIMO



3/8"



VALIGETTA CON 28 BUSSOLE TORX CORTE/LUNG



FINITURA
CROMATA

| |
|---------------|
| 53061 |
| 43,00€ |

| | |
|----|------|
| Kg | 2,19 |
| ff | 10 |
| | 180 |



FINITURA
SATINATA

| |
|---------------|
| 51930 |
| 42,00€ |

| | |
|----|------|
| Kg | 2,19 |
| ff | 10 |
| | 240 |

1/4"

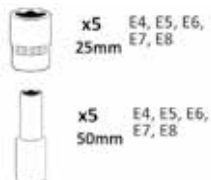

3/8"

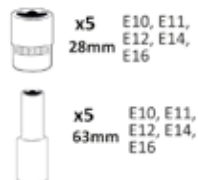

1/2"

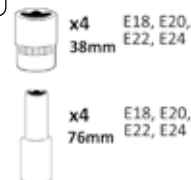

SET DI 12 PEZZI CON INNESTO 1/2" IMPRONTA TORX



FINITURA
CROMATA

| |
|---------------|
| 53103 |
| 33,00€ |

| | |
|----|------|
| Kg | 1,80 |
| ff | 10 |
| | 330 |



FINITURA
SATINATA

| |
|---------------|
| 51261 |
| 32,00€ |

| | |
|----|------|
| Kg | 1,62 |
| ff | 10 |
| | 360 |



55mmL: T20, T25,
T30, T40, T45, T50
65mmL: T55
70mmL: T60, T70,
T80, T90, T100

➤ **RICAMBI DISPONIBILI
CONSULTA IL NOSTRO CATALOGO**

SET DI 12 PEZZI CON INNESTO 1/2" IMPRONTA TRIPLE SQUARE



1/2"

12 PCS

FINITURA CROMATA

53104

33,00€

1,75

10

240



FINITURA SATINATA

51384

32,00€

1,55

10

360



55mmL: M4, M5, M6, M7, M8, M9

65mmL: M10

70mmL: M12, M14, M16, M18, M20

➤ **RICAMBI DISPONIBILI**
CONSULTA IL NOSTRO CATALOGO

SET DI 12 PEZZI CON INNESTO 1/2" IMPRONTA ESAGONALE



1/2"

12 PCS

FINITURA CROMATA

53105

33,00€

2,10

10

240



FINITURA SATINATA

51260

32,00€

1,92

10

360



55mmL: H5, H6, H7, H8, H10, H12

65mmL: H14

70mmL: H16, H17, H18, H19, H22

➤ **RICAMBI DISPONIBILI**
CONSULTA IL NOSTRO CATALOGO

SET DI 6 PEZZI CON INNESTO 1/2" IMPRONTA TORX ANTINTRUSIONE

51410

37,50€

0,38 5 20 500



1/2"

6 PCS



x6
T55, T60, T70, T80, T90, T100

SET DI 6 PEZZI CON INNESTO 1/2" IMPRONTA TRIPLE SQUARE / XZN ANTINTRUSIONE

51409

37,50€

0,34 5 20 500



1/2"

6 PCS



x6
M10, M12, M14, M16, M18, M20

VALIGETTA CON 55 INSERTI PER VITI

| | | | |
|---------------|------|----|-----|
| 52753 | 2,96 | 4 | 184 |
| 95,00€ | Kg | ff | ff |

S-2 **55 PCS**

➤ **RICAMBI DISPONIBILI**
CONSULTA IL NOSTRO CATALOGO

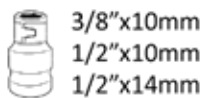

HEAVY DUTY

CARATTERISTICHE

H4, H5, H6, H7, H8, H10, H12, H14, H16
ISO 2136 (30 & 75mm)

T20, T25, T30, T40, T45, T50, T55, T60,
T70, T80 (30 & 75mm)

M5, M6, M8, M10, M12, M14, M16
DIN 2325 (30 & 75mm)

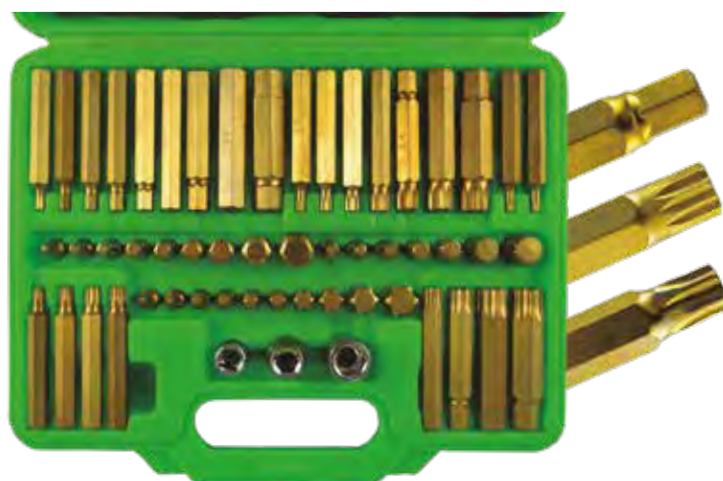

VALIGETTA CON 42 CHIAVI PER VITI TORX, TRIPLE SQUARE E A BRUGOLA STANDARD

42 PCS

S-2

INVIOLABILE

S-2

| | | | |
|---------------|------|----|-----|
| 50983 | 1,77 | 5 | 200 |
| 42,00€ | Kg | ff | ff |

| | | | |
|---------------|------|----|-----|
| 50985 | 1,74 | 5 | 240 |
| 54,00€ | Kg | ff | ff |

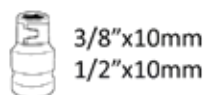

50983 50985 CARATTERISTICHE

4, 5, 6, 7, 8, 10, 12 (30mm)
4, 5, 6, 7, 8, 10, 12 (75mm)

T20, T25, T30, T40, T45, T50, T55, T60 (30mm)
T20, T25, T30, T40, T45, T50, T55, T60 (75mm)

M5, M6, M8, M10, M12 (30mm)
M5, M6, M8, M10, M12 (75mm)



➤ **RICAMBI DISPONIBILI**
CONSULTA IL NOSTRO CATALOGO

VALIGETTA CON 75 CHIAVI PER VITI RIBE 12 RIGHE, TORX, TORX ANTIMANOMISSIONE E ESAGONALE

➤ **RICAMBI DISPONIBILI**
CONSULTA IL NOSTRO CATALOGO

| | | | |
|---------------|------|----|----|
| 52550 | 3,61 | 4 | 72 |
| 82,00€ | Kg | ff | ff |

S-2 **75 PCS**

CARATTERISTICHE

4, 5, 6, 7, 8, 10, 12
(30 & 75mm)

T20, T25, T30, T40, T45, T50,
T55, T60, (30 & 75mm)

M5, M6, M8, M10, M12
(30 & 75mm)

M5, M6, M7, M8, M9, M10,
M12, M14 (30 & 75mm)

T20H, T25H, T30H, T40H, T45H,
T50H, T55H, T60H (30 & 75mm)

3/8" 10mm / 1/2" 10mm (x2)

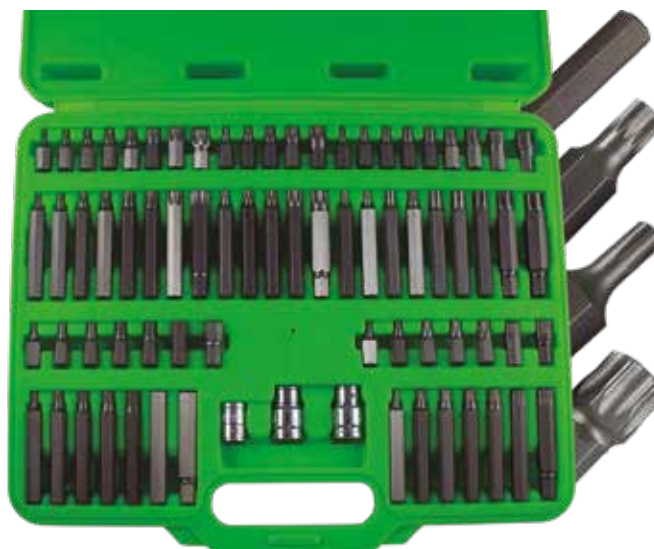

SET DI INSERTI POLIGONALI 26 PEZZI

➤ **RICAMBI DISPONIBILI**
CONSULTA IL NOSTRO CATALOGO

| | | | | | | |
|---------------|---|---|---|---|------|------------------|
| 52603 | 4,07 | 4 | 144 |  | 1/2" | 26 PCS |
| 68,50€ |  |  |  | | | |



55mm: M5, M6, M8, M9, M10, M12, M14, M16
100mm: M5, M6, M8, M9, M10, M12, M14
140mm: M5, M6, M8, M9, M10, M12, M14
200mm: M8, M10, M12, M14

| | | | | | | |
|---------------|---|---|---|---|------|------------------|
| 52606 | 5,16 | 4 | 144 |  | 1/2" | 32 PCS |
| 75,00€ |  |  |  | | | |



55mm: M5, M6, M7, M8, M9, M10, M12, M13, M14
100mm: M5, M6, M7, M8, M9, M10, M12, M13, M14
140mm: M7, M8, M9, M10, M12, M13, M14
200mm: M7, M8, M9, M10, M12, M13, M14



SET DI INSERTI HEXAGONALE 30 PEZZI

➤ **RICAMBI DISPONIBILI**
CONSULTA IL NOSTRO CATALOGO

| | | | | | | |
|---------------|---|---|---|---|------|------------------|
| 52604 | 4,62 | 4 | 128 |  | 1/2" | 30 PCS |
| 73,00€ |  |  |  | | | |



55mm: H5, H6, H7, H8, H10, H12, H14, H17, H19
100mm: H5, H6, H7, H8, H10, H11, H12, H13
140mm: H5, H6, H7, H8, H10, H12, H14
200mm: H5, H6, H7, H8, H10, H12

| | | | | | | |
|---------------|---|---|---|---|------|------------------|
| 52605 | 4,67 | 4 | 144 |  | 1/2" | 32 PCS |
| 73,00€ |  |  |  | | | |



55mm: T20, T25, T27, T30, T40, T45, T50, T55, T60, T70
100mm: T20, T25, T27, T30, T40, T45, T50, T55, T60, T70
140mm: T40, T45, T50, T55, T60, T70
200mm: T40, T45, T50, T55, T60, T70

STRUMENTI IN POLLICI

VALIGETTA PORTAUTENSILI CON 35 PEZZI IN POLLICI

35
PCS



FINITURA SATINATA

| | | | |
|---------------|------|----|----|
| 51885 | 4,42 | 4 | 96 |
| 84,00€ | Kg | ff | ff |

FINITURA CROMATA

| | | | |
|---------------|------|----|-----|
| 53076 | 4,97 | 3 | 108 |
| 86,00€ | Kg | ff | ff |

1/2"

x17 5/16", 3/8", 7/16", 1/2", 9/16", 19/32", 5/8", 11/16", 3/4", 13/16", 7/8", 15/16", 1", 1-1/16", 1-1/8", 1-3/16", 1-1/4"

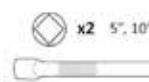

1/4"

x8 3/16", 7/32", 1/4", 9/32", 5/16", 11/32", 3/8", 7/16"

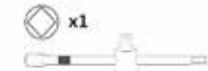
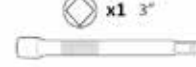
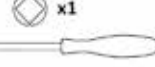

➤ **RICAMBI DISPONIBILI**
CONSULTA IL NOSTRO CATALOGO

KIT DA 17 CHIAVI COMBinate IN POLLICI

17
PCS

FINITURA SATINATA

| | | | |
|---------------|------|----|-----|
| 51890 | 3,92 | 4 | 192 |
| 87,00€ | Kg | ff | ff |

FINITURA CROMATA

| | | | |
|---------------|------|----|--|
| 52972 | 4,60 | 4 | |
| 87,00€ | Kg | ff | |



5/16", 3/8", 7/16", 1/2", 9/16", 19/32", 5/8", 11/16", 3/4", 13/16", 7/8", 15/16", 1", 1-1/16", 1-1/8", 1-3/16", 1-1/4"



KIT DA 10 CHIAVI A BRUGOLA IN POLLICI

10
PCS

| | | | | |
|---------------|------|----|----|-------|
| 51970 | 0,28 | 10 | 60 | 1.500 |
| 11,00€ | Kg | ff | ff | ff |

1/16", 5/64", 3/32", 1/8", 5/32", 3/16", 7/32", 1/4", 5/16", 3/8"



VALIGETTE PORTAUTENSILI IN ALLUMINIO

VALIGETTA PORTAUTENSILI ALLUMINIO 198PCS

198
PCS

| | | | | | | |
|----------------|------|---|----|--|------|------|
| 53160 | 12,1 | 1 | 32 | | 1/2" | 1/4" |
| 272,50€ | Kg | | | | | |



VALIGETTI PORTAUTENSILI ALLUMINIO 108PCS

108
PCS

| | | | | | | |
|----------------|------|---|----|--|------|------|
| 53158 | 8,60 | 1 | 32 | | 3/8" | 1/4" |
| 167,00€ | Kg | | | | | |

| | | | | | | |
|----------------|-----|---|----|--|------|------|
| 53444 | 8,2 | 1 | 36 | | 1/2" | 1/4" |
| 185,50€ | Kg | | | | | |

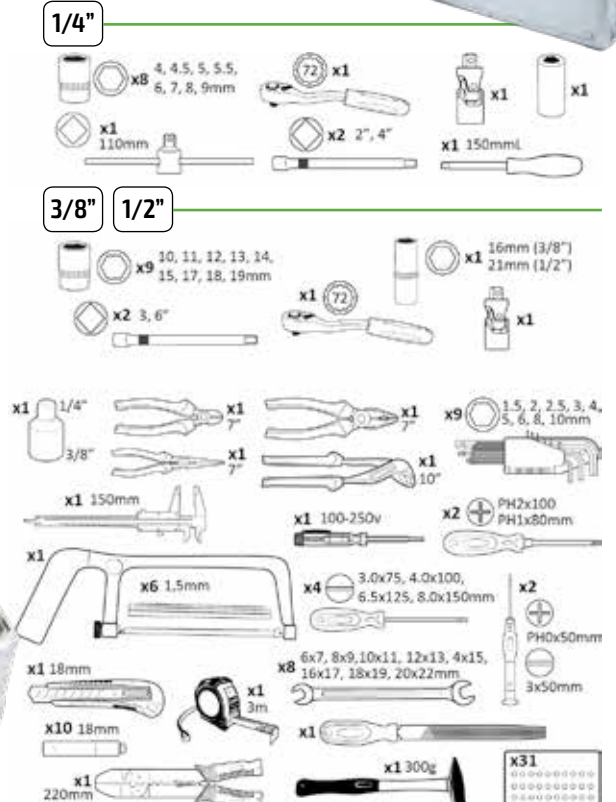

VALIGETTE PORTAUTENSILI IN ALLUMINIO

VALIGETTI PORTAUTENSILI ALLUMINIO 159PCS

159
PCS

| | | | |
|---------|-------|---|----|
| 53159 | 13,30 | 1 | 32 |
| 288,50€ | Kg | | |



COMPRESO DA:



1/4"



1/2"

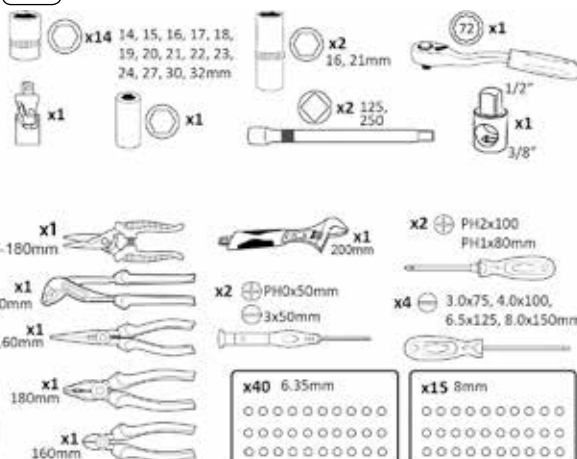

VALIGETTA PORTAUTENSILI CON 38 PEZZI E BUSSOLE + CRICCHETTO MINI DA 1/4"

53156

23,50€

0,48

6

36

1.008



**37
PCS**



1/4"

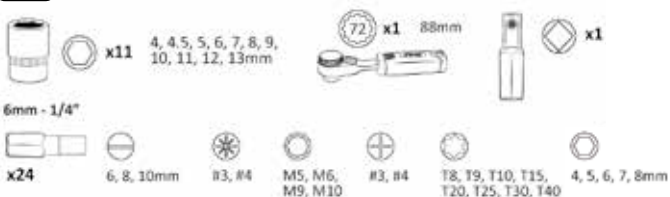

SET DI INSERTI 1/2"

10, 11, 12, 13, 14, 15,
16, 17, 18, 19mm

52714

14,00€

0,65

4

24

576



1/2"



52716

15,00€

0,60

4

24

576



1/2"



➤ **RICAMBI DISPONIBILI**
CONSULTA IL NOSTRO CATALOGO

SET DI INSERTI TORX 3/8" - 1/2"

53084

21,00€

0,70

5

20



1/2"

3/8"



3/8": T30, T40, T45, T50
1/2": T55, T60, T70



VALIGETTA PORTAUTENSILI 37 PEZZI E BUSSOLE + CRICCHETTO MINI DA 1/4"

52198

32,00€

0,45

6

36

1.800



**37
PCS**



1/4"



SET DI INSERTI 1/4"

4, 4.5, 5, 5.5, 6, 7, 8, 9,
10, 11, 12, 13, 14mm

52715

8,50€

0,27

6

36

1.152



1/4"



52717

9,50€

0,27

6

36

1.152



1/4"



➤ **RICAMBI DISPONIBILI**
CONSULTA IL NOSTRO CATALOGO

SET DI INSERTI TORX 1/4" A PROVA DI MANOMISSIONE

53127

8,50€

0,10

100

1.000



1/4"



T10, T15, T20, T25,
T30, T40, T45



GUIDA METALLICA

SET DI INSERTI 1/4" 18 PEZZI

| | | | | | | | | |
|---------------|------|---|----|-------|------|-----|-----------|--|
| 52909 | 0,35 | 8 | 32 | 1.500 | 1/4" | S-2 | 18 PCS | |
| 11,00€ | | | | | | | | |



| | | | |
|--|-------------------------------------|--|---------------|
| | T8, T10, T15, T20, T25, T27, T30 | | 4, 5,5, 6,5mm |
| | #1, #2 | | #1, #2 |
| | | | 3, 4, 5, 6mm |

SET DI INSERTI 1/4" 30 PEZZI

| | | | | | | | | |
|---------------|------|---|----|-----|------|-----|-----------|--|
| 52908 | 0,60 | 8 | 32 | 500 | 1/4" | S-2 | 30 PCS | |
| 16,00€ | | | | | | | | |



| | | | |
|--|---|--|------------------|
| | T8, T9, T10, T15, T20, T25, T27, T30 | | 4, 5,5, 6,5, 7mm |
| | #0, #1, #2 | | 3, 4, 5, 6mm |
| | #0, #1, #2 | | |

SET DI INSERTI TS A 5 PUNTE ANTINTRUSIONE

| | | | | | |
|---------------|-----|---|----|--|----------|
| 51746 | 0,2 | 5 | 75 | | 7 PCS |
| 10,00€ | | | | | |



TS10, 15, 20,
25, 30, 40, 45



SET DI INSERTI RIBE

| | | | | | |
|---------------|------|---|----|-----|--|
| 50980 | 0,76 | 5 | 20 | 300 | |
| 21,00€ | | | | | |

| | | | | | |
|---------------|------|----|----|-----|--|
| 50982 | 0,46 | 10 | 40 | 300 | |
| 21,00€ | | | | | |

| | | | | | |
|---------------|------|---|----|-----|--|
| 52320 | 0,76 | 5 | 20 | 480 | |
| 21,00€ | | | | | |



50980 1/2" 3/8"

1/2" 100mm:
M12, M13, M14
3/8" 90mm:
M6, M7, M8, M10

50982 3/8"

3/8" 100mm HB3:
4, 5, 6, 7, 8, 10mm

52320 1/2" 3/8"

1/2" 100mm:
M12, M13, M14
3/8" 90mm:
M6, M7, M8, M10

BUSSOLA PUNTA XZN SP. VAG

| | | |
|--|------|--|
| | 1/2" | |
|--|------|--|

INVIOLABILE 16x58MM

| | | | | |
|--------------|------|----|----|-------|
| 12029 | 0,17 | 25 | 50 | 1.500 |
| 3,50€ | | | | |



INVIOLABILE 16x100MM

| | | | | |
|--------------|------|----|----|-------|
| 12030 | 0,25 | 25 | 50 | 1.500 |
| 6,50€ | | | | |



INSERTI POLIGONALE EXTRALUNGO 800mm 1/2" 8mm Ø

| | | | | |
|---------------|------|----|-------|--------------|
| 52059 | 0,58 | 25 | 1.750 | Ø 8mm, 800mm |
| 35,50€ | | | | |

| | | | | |
|---------------|------|----|-------|---------------|
| 52060 | 0,58 | 25 | 1.750 | Ø 10mm, 800mm |
| 35,50€ | | | | |



SET DI INSERTI

| | | | | | |
|---------------|------|---|-----|---------|------------------|
| 52539 | 1,90 | 5 | 128 | ALLEN 8 | 85 PCS |
| 62,00€ | Kg | | | | |

| REF. | DESCRIZIONE | X | € | REF. | DESCRIZIONE | X | € |
|-------|----------------------------|---|--------------|-------|-----------------------------------|---|--------------|
| 10135 | 8mm punta Hex.7mm | 5 | 0,60€ | 10145 | 8mm doppia punta Phillips (PZ) #3 | 5 | 0,60€ |
| 10136 | 8mm punta Hex. 8mm | 5 | 0,60€ | 10146 | 8mm doppia punta Phillips (PZ) #4 | 5 | 0,60€ |
| 10137 | 8mm punta Hex. 10mm | 5 | 0,90€ | 10147 | 8mm Torx punta (TX) T40 | 5 | 0,60€ |
| 10138 | 8mm punta Hex. 12mm | 5 | 1,00€ | 10148 | 8mm Torx punta (TX) T45 | 5 | 0,60€ |
| 10139 | 8mm punta Hex. 14mm | 5 | 1,50€ | 10149 | 8mm Torx punta (TX) T50 | 5 | 0,60€ |
| 10144 | 8mm punta Hex. 8mm | 5 | 0,60€ | 10150 | 8mm Torx punta (TX) T55 | 5 | 0,70€ |
| 10140 | 8mm (-) punta 10mm | 5 | 0,90€ | 10151 | 8mm Torx punta (TX) T60 | 5 | 0,90€ |
| 10141 | 8mm (-) punta 12mm | 5 | 1,00€ | | | | |
| 10142 | 8mm Phillips punta (PH) #3 | 5 | 0,60€ | | | | |
| 10143 | 8mm Phillips punta (PH) #4 | 5 | 0,60€ | | | | |

➤ **RICAMBI DISPONIBILI**
CONSULTA IL NOSTRO CATALOGO



SET DI CHIAVI A BUSSOLA A GIRAVITE

| | | | | | |
|---------------|------|----|-----|------|------------------|
| 52538 | 2,07 | 16 | 128 | 1/4" | 90 PCS |
| 62,00€ | Kg | | | | |

| REF. | DESCRIZIONE | X | € | REF. | DESCRIZIONE | X | € |
|-------|-------------------------|---|--------------|-------|----------------|---|--------------|
| 10117 | Phillips (PH) #1 | 5 | 0,80€ | 10127 | - (-) 6.5mm | 5 | 0,80€ |
| 10118 | Phillips (PH) #2 | 5 | 0,80€ | 10128 | Torx (TX) 8mm | 5 | 0,80€ |
| 10119 | Double Phillips (PZ) #1 | 5 | 0,80€ | 10129 | Torx (TX) 10mm | 5 | 0,80€ |
| 10120 | Double Phillips (PZ) #2 | 5 | 0,80€ | 10130 | Torx (TX) 15mm | 5 | 0,80€ |
| 10121 | Hex. 3mm | 5 | 0,80€ | 10131 | Torx (TX) 20mm | 5 | 0,80€ |
| 10122 | Hex. 4mm | 5 | 0,80€ | 10132 | Torx (TX) 25mm | 5 | 0,80€ |
| 10123 | Hex. 5mm | 5 | 0,90€ | 10133 | Torx (TX) 27mm | 5 | 0,80€ |
| 10124 | Hex. 6mm | 5 | 0,80€ | 10134 | Torx (TX) 30mm | 5 | 0,80€ |
| 10125 | - (-) 4mm | 5 | 0,80€ | | | | |
| 10126 | - (-) 5.5mm | 5 | 0,80€ | | | | |

➤ **RICAMBI DISPONIBILI**
CONSULTA IL NOSTRO CATALOGO



SET DI 6 ADATTATORI

| | | | | | | | |
|---------------|-----|----|----|-----|--|-----------------|---|
| 51333 | 0,5 | 10 | 40 | 640 | | 6 PCS | 1/4"-3/8", 3/8"-1/2", 1/2"-3/4", 3/8"-1/4", 1/2"-3/8", 3/4"-1/2" |
| 15,50€ | Kg | | | | | | |



ADATTATORI

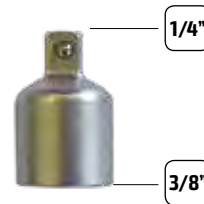

| | | | |
|--------------|------|-----|-------|
| 51877 | 0,02 | 200 | 2.000 |
| 3,50€ | Kg | | |

| | | | | |
|--------------|------|---|-----|-------|
| 50508 | 0,06 | 5 | 100 | 2.000 |
| 3,50€ | Kg | | | |

SET DI 3 ADATTATORI MAGNETICI

| | | | | | |
|---------------|------|---|----|-------|-----------------|
| 51802 | 0,25 | 9 | 36 | 1.000 | 3 PCS |
| 16,00€ | Kg | | | | |

1/2" 3/8" 1/4"



ALTA TENSIONE

VALIGETTA PORTAUTENSILI ISOLATI 21 PEZZI

| | | | |
|----------------|------|----|----|
| 53153 | 4,80 | 3 | 54 |
| 409,50€ | Kg | ff | |

1/2" 21 PCS



1/2"

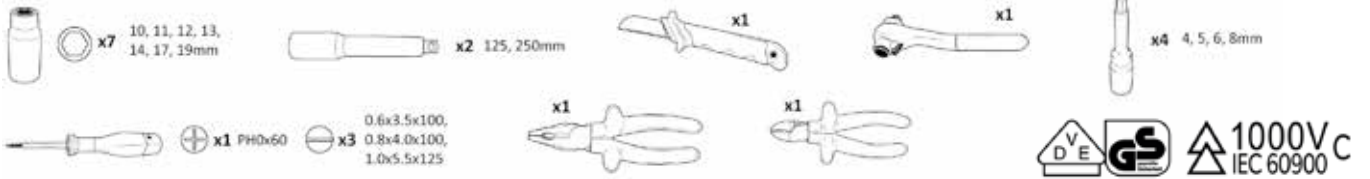

SET DI CHIAVI ISOLATI

| | | | |
|----------------|------|----|----|
| 53152 | 4,70 | 3 | 72 |
| 378,00€ | Kg | ff | |



20 PCS

6-7-8-9-10-11-12-13-14-15-16-17-18-19-21-22-24-27-30-32mm



VALIGETTA PORTAUTENSILI ISOLATI 20 PEZZI DI 3/8"

| | | | |
|----------------|-----|----|----|
| 53154 | 3,3 | 3 | 72 |
| 471,00€ | Kg | ff | |

| | | |
|-----|----|----|
| 3,3 | 3 | 72 |
| Kg | ff | |

3/8"

20 PCS



x12 8, 10, 11, 12, 13, 14, 16, 17, 18, 19, 21, 22mm

x1 200mm

x1 200mm

x4 4x75, 5x75, 6x75, 8x75mm

x2 125, 250mm



ALTA TENSIONE

SET DI PUNTE E CACCIAVITE ELETTRICAMENTE ISOLATO SINO A 1000V

| | | | |
|---------------|------|----|----|
| 52009 | 0,34 | 10 | 50 |
| 36,00€ | Kg | 56 | ff |

Ottimo per lavori con elettricità
Utensilio di sicurezza

| | |
|--|--|
| | 0,4x2,5x100 0,8x4,0x100 0,6x3,5x100 1,2x6,5x100 |
|--|--|

| | |
|--|--------------------|
| | PH1x100 PH2x100 |
|--|--------------------|

DIN EN60900:2005-01 - EN60900:2004



COMPATTO,
RISPARMIA SPAZIO



SET DI CACCIAVITI ELETTRICAMENTE ISOLATI FINO A 1000V

| | | | | |
|----------------|------|----|-----|-------------------|
| 52521 | 1,43 | 6 | 240 | 50 PCS |
| 120,00€ | Kg | ff | ff | |

| | |
|--|---|
| | 0.4x2.0x100, 0.4x2.5x100, 0.5x3.0x100, 0.6x3.5x100, 0.8x4.0x100, 1.0x5.5x100, 1.2x6.5x100 |
|--|---|

| | |
|--|--|
| | T6x100, T8x100, T9x100, T10x100, T15x100, T20x100, T25x100, T27x100, T30x100 |
|--|--|

| | |
|--|--|
| | 6.3x89, 8.1x89, Voltage Tester 3.0x70 + Torx 31x105 |
|--|--|

| | |
|--|---------------------------------------|
| | M4x4.0x100, M5x5.0x100, M6x5.0x100 |
|--|---------------------------------------|

| | |
|--|---|
| | H2.5x100, H3.0x100, H4.0x100, H5x100, H6.0x100 |
|--|---|

| | |
|--|-------------------------------|
| | 1x100, 2x100, 3x100, 4x100 |
|--|-------------------------------|

| | |
|--|--------------------------------|
| | 4X100, 6x100, 8x100, 10x100 |
|--|--------------------------------|

| | |
|--|------------------------------|
| | PH0x100, PH1x100, PH2x100 |
|--|------------------------------|

| | |
|--|--------------------------------|
| | 4x100, 6x100, 8x100, 10x100 |
|--|--------------------------------|

| | |
|--|----------------|
| | R1x100, R2x100 |
|--|----------------|

| | |
|--|------------------------------|
| | PZ0x100, PZ1x100, PZ2x100 |
|--|------------------------------|



AC 1000V
IEC 60900:2004

COLTELLO ISOLATO

DIRITTO

| | |
|---------------|------|
| 53164 | |
| 15,00€ | |
| Kg | 0,10 |
| ff | 6 |
| ff | 36 |



PIEGATO

| | |
|---------------|------|
| 53165 | |
| 18,00€ | |
| Kg | 0,10 |
| ff | 6 |
| ff | 36 |



180mm 50mm



SET DI 7 CACCIAVITI ELETTRICAMENTE ISOLATI FINO A 1.000V

| | | | |
|---------------|------|----|-----|
| 52519 | 0,14 | 30 | 840 |
| 34,00€ | Kg | ff | ff |

| | |
|--|--|
| | 1.5x0.23x50, 1.8x0.30x50, 2.0x0.40x50, 2.5x0.40x50, 3.0x0.50x50mm |
|--|--|

| | |
|--|-------------------|
| | PH0x50 - PH0x50mm |
|--|-------------------|

| | | | |
|---------------|------|----|-----|
| 52520 | 0,67 | 12 | 288 |
| 42,00€ | Kg | ff | ff |

| | |
|--|--|
| | 0.4x2.5x75, 0.8x4.0x100, 1.0x5.5x125, 1.2x6.5x150mm |
|--|--|

| | |
|--|--|
| | PH0x60, PH1x80, PH2x100mm Voltage Tester 3.0x70mm |
|--|--|



AC 1000V
IEC 60900:2004



UTENSILI MANUALI

| | |
|--|----|
| CHIAVI COMBINATI A CRICCHETTO | 32 |
| KIT DI CHIAVI | 34 |
| CHIAVI ALLEN | 37 |
| CHIAVI IN POLLICI | 37 |
| CACCIAVITI | 38 |
| CACCIAVITI A TAGLIO USO SCALPELLO . 39 | |
| CHIAVE INGLESE | 40 |
| MARTELLI | 41 |
| SEGHE | 42 |
| PUNZONI | 42 |
| RIVETTATRICI | 43 |
| CRICCHETTI | 45 |
| CHIAVI LUNGHE SNODATE | 47 |
| CHIAVI A CROCE | 47 |
| BARRE DI ESTENSIONE | 48 |
| CACCIAVITI A TAGLIO USO SCALPELLO | 40 |
| TAGLIATUBI | 49 |
| PINZA | 50 |
| CHIAVI STILLSON | 56 |
| MORSETTI | 56 |
| CESOIE | 56 |



SET DI 12 CHIAVI COMBinate A CRICCHETTO SNODATE

| | | | | | | | |
|---------------|------|---|----|-----|--|---------------|--|
| 51318 | 2,15 | 5 | 10 | 200 | | 12 PCS | |
| 98,00€ | | | | | | | |

8, 9, 10, 11, 12, 13, 14, 15, 16, 17, 18, 19mm

Testa snodata da 0° a 180°.
Cricchetto a 72 denti con angolo di ripresa di 5°.
Confezione: in blister rigido nero.



SET DI 7 CHIAVI COMBinate A CRICCHETTO SNODATE

| | | | | | | | |
|---------------|------|---|----|-----|--|--------------|--|
| 53017 | 1,18 | 5 | 10 | 320 | | 7 PCS | |
| 57,50€ | | | | | | | |

8, 10, 11, 13, 14, 17, 19mm



RICAMBI DISPONIBILI

| REF. | Ø | Kg | Box | Tray | Tray | € |
|-------|------|------|-----|------|------|--------|
| 10552 | 8mm | 0,06 | 5 | | | 17,50€ |
| 10553 | 9mm | 0,07 | 5 | | | 18,00€ |
| 10554 | 10mm | 0,09 | 10 | | | 18,50€ |
| 10555 | 11mm | 0,09 | 5 | | | 19,50€ |
| 10556 | 12mm | 0,11 | 5 | | | 20,50€ |
| 10557 | 13mm | 0,13 | 10 | | | 21,00€ |
| 10558 | 14mm | 0,15 | 5 | | | 22,00€ |
| 10559 | 15mm | 0,16 | 5 | | | 23,00€ |
| 10560 | 16mm | 0,19 | 5 | | | 24,50€ |
| 10561 | 17mm | 0,22 | 5 | | | 25,50€ |
| 10562 | 18mm | 0,26 | 5 | | | 26,50€ |
| 10563 | 19mm | 0,28 | 5 | | | 27,50€ |

SET 6 CHIAVI A CRICCHETTO

| | | | | | | | |
|---------------|------|---|----|-------|--|--------------|--|
| 53021 | 0,86 | 5 | 20 | 1.500 | | 6 PCS | |
| 48,50€ | | | | | | | |



6 PCS

8x9, 10x11, 12x13, 14x15, 16x18, 17x19mm



RICAMBI DISPONIBILI

| REF. | Ø | Kg | Box | Tray | Tray | € |
|-------|---------|------|-----|------|------|--------|
| 13485 | 8x9mm | 0,06 | 5 | | | 9,50€ |
| 13486 | 10x11mm | 0,09 | 5 | | | 10,50€ |
| 13487 | 12x13mm | 0,12 | 5 | | | 12,00€ |
| 13488 | 14x15mm | 0,15 | 5 | | | 13,50€ |
| 13489 | 16x18mm | 0,2 | 5 | | | 16,00€ |
| 13490 | 17x19mm | 0,25 | 5 | | | 17,00€ |

SET DI 7 CHIAVI CON EXTRA RATCHET LUNGO

| | | | | | | | |
|---------------|------|---|-----|--|--|--------------|--|
| 53019 | 2,33 | 5 | 175 | | | 7 PCS | |
| 71,50€ | | | | | | | |



8mm (23,5mmL)
10mm (29,3mmL)
12mm (32,8mmL)
13mm (34,9mmL)
14mm (36,7mmL)
17mm (41mmL)
19mm (42mmL)

RICAMBI DISPONIBILI

| REF. | Ø | Kg | Box | Tray | Tray | € |
|-------|------|------|-----|------|------|--------|
| 13453 | 8mm | 0,1 | 5 | | | 10,00€ |
| 13454 | 10mm | 0,15 | 5 | | | 10,50€ |
| 13455 | 12mm | 0,21 | 5 | | | 11,00€ |
| 13456 | 13mm | 0,23 | 5 | | | 12,50€ |
| 13457 | 14mm | 0,28 | 5 | | | 13,50€ |
| 13460 | 17mm | 0,44 | 5 | | | 16,50€ |
| 13462 | 19mm | 0,53 | 5 | | | 18,00€ |



SET DI 8 CHIAVI COMBinate A CRICCHETTO SNODATE CORTE

| | | | | | | | |
|---------------|------|---|----|-------|--|--------------|--|
| 53022 | 0,82 | 5 | 20 | 1.500 | | 8 PCS | |
| 46,50€ | | | | | | | |



10, 11, 12, 13, 14, 15, 17, 19mm



RICAMBI DISPONIBILI

| REF. | Ø | Kg | Box | Tray | Tray | € |
|-------|------|------|-----|------|------|-------|
| 13491 | 10mm | 0,05 | 5 | | | 5,00€ |
| 13492 | 11mm | 0,06 | 5 | | | 5,00€ |
| 13493 | 12mm | 0,07 | 5 | | | 5,00€ |
| 13494 | 13mm | 0,08 | 5 | | | 5,50€ |
| 13495 | 14mm | 0,09 | 5 | | | 6,00€ |
| 13496 | 15mm | 0,12 | 5 | | | 6,50€ |
| 13497 | 17mm | 0,14 | 5 | | | 7,00€ |
| 13498 | 19mm | 0,19 | 5 | | | 8,00€ |



SET DI 22 CHIAVI COMBINATI A CRICCHETTO

| | | | |
|----------------|------|----|----|
| 53020 | 7,38 | 2 | 54 |
| 230,00€ | Kg | ff | |



22
PCS

6, 7, 8, 9, 10, 11, 12, 13, 14,
15, 16, 17, 18, 19, 20, 21, 22,
23, 24, 27, 30, 32mm

► RICAMBI DISPONIBILI

| REF. | | | | € | REF. | | | | € |
|-------|------|------|---|--------|-------|------|------|---|--------|
| 13463 | 6mm | 0,03 | 5 | 6,50€ | 13474 | 17mm | 0,19 | 5 | 10,50€ |
| 13464 | 7mm | 0,04 | 5 | 6,50€ | 13475 | 18mm | 0,22 | 5 | 11,00€ |
| 13465 | 8mm | 0,05 | 5 | 6,50€ | 13476 | 19mm | 0,22 | 5 | 12,00€ |
| 13466 | 9mm | 0,06 | 5 | 7,00€ | 13477 | 20mm | 0,23 | 5 | 13,00€ |
| 13467 | 10mm | 0,1 | 5 | 7,00€ | 13478 | 21mm | 0,37 | 5 | 14,00€ |
| 13468 | 11mm | 0,08 | 5 | 7,00€ | 13479 | 22mm | 0,37 | 5 | 15,00€ |
| 13469 | 12mm | 0,09 | 5 | 7,50€ | 13480 | 23mm | 0,37 | 5 | 16,00€ |
| 13470 | 13mm | 0,1 | 5 | 8,50€ | 13481 | 24mm | 0,53 | 5 | 17,00€ |
| 13471 | 14mm | 0,11 | 5 | 9,00€ | 13482 | 27mm | 0,74 | 5 | 25,50€ |
| 13472 | 15mm | 0,13 | 5 | 9,50€ | 13483 | 30mm | 0,89 | 5 | 30,00€ |
| 13473 | 16mm | 0,15 | 5 | 10,00€ | 13484 | 32mm | 1,12 | 5 | 38,50€ |



SET DI 6 CHIAVI A CRICCHETTO SNODATE

| | | | |
|----------------|------|----|-----|
| 53018 | 2,66 | 5 | 125 |
| 136,00€ | Kg | ff | |



6
PCS



8x9,10x11, 12x13, 14x15,
16x18, 17x19mm



► RICAMBI DISPONIBILI

| REF. | | | | € |
|-------|---------|------|---|--------|
| 13447 | 8x9mm | 0,11 | 5 | 19,00€ |
| 13448 | 10x11mm | 0,17 | 5 | 20,00€ |
| 13449 | 12x13mm | 0,22 | 5 | 23,50€ |
| 13450 | 14x15mm | 0,31 | 5 | 26,50€ |
| 13451 | 16x18mm | 0,45 | 5 | 32,50€ |
| 13452 | 17x19mm | 0,47 | 5 | 33,50€ |

SET DI 4 CHIAVI AD ANELLO TORX COMBINATE A CRICCHETTO SNODATE

| | | | |
|---------------|------|----|-----|
| 50754 | 0,82 | 20 | 360 |
| 65,00€ | Kg | ff | |



4
PCS

E6 x E8
E10 x E12
E14 x E18
E20 x E24

Testa snodata da 0° a 180°.
Cricchetto a 72 denti con angolo di ripresa di 5°.

► RICAMBI DISPONIBILI

| REF. | | | | € |
|-------|---------|------|---|--------|
| 10527 | E6XE8 | 0,09 | 5 | 43,00€ |
| 10528 | E10XE12 | 0,12 | 5 | 46,00€ |
| 10529 | E14XE18 | 0,22 | 5 | 49,00€ |
| 10530 | E20XE24 | 0,37 | 5 | 52,50€ |



SET DI 10 CHIAVI ESAGONALI COMBINATE CON CRICCHETTO A FORCHETTA

| | | | |
|----------------|------|----|-----|
| 51840 | 1,97 | 10 | 240 |
| 324,50€ | Kg | ff | |



10
PCS

10, 11, 12, 13,
14, 15, 16, 17,
18, 19mm



VALIGETTA CON 6 CHIAVI A BUSSOLA POLIGONALI ARICOLATE

| | | | | | |
|---------------|------|----|-----|--|-----------------|
| 51659 | 1,60 | 10 | 230 | | 6 PCS |
| 62,00€ | Kg | | | | |

8-9, 10-11, 12-13,
14-15, 16-17, 18-19mm

► RICAMBI DISPONIBILI

| REF. | | Kg | | € |
|-------|-----------|------|---|--------|
| 10621 | XZN 8-9 | 0,09 | 5 | 11,00€ |
| 10622 | XZN 10-11 | 0,13 | 5 | 12,00€ |
| 10623 | XZN 12-13 | 0,16 | 5 | 14,00€ |
| 10624 | XZN 14-15 | 0,20 | 5 | 15,50€ |
| 10625 | XZN 16-17 | 0,29 | 5 | 18,00€ |
| 10626 | XZN 18-19 | 0,37 | 5 | 20,50€ |



SET DI 4 CHIAVI A BUSSOLA SNODATE IMPRONTA TORX

| | | | | | |
|---------------|------|----|-----|--|-----------------|
| 50622 | 1,07 | 10 | 320 | | 4 PCS |
| 47,50€ | Kg | | | | |

E6xE8, E10xE12,
E14xE18, E20xE24



KIT DI CHIAVI COMBinate

14 CHIAVI

7 CHIAVI

| | | | | | |
|---------------|------|---|----|-----|--------------------------|
| 50560 | 1,25 | 5 | 20 | 240 | FINITURA SATINATA |
| 33,00€ | Kg | | | | |

| | | | | | |
|---------------|------|---|----|-----|-------------------------|
| 52970 | 1,30 | 2 | 16 | 384 | FINITURA CROMATA |
| 36,50€ | Kg | | | | |

| | | | | | |
|---------------|------|---|---|-----|--------------------------|
| 50896 | 3,00 | 2 | 6 | 216 | FINITURA SATINATA |
| 49,50€ | Kg | | | | |

| | | | | | |
|---------------|------|---|---|-----|-------------------------|
| 52971 | 2,55 | 2 | 8 | 224 | FINITURA CROMATA |
| 52,00€ | Kg | | | | |

| | | | |
|--|-----------------|--|---------------------------------|
| | 7 PCS | | 20, 21, 22, 24, 27, 30, 32mm |
|--|-----------------|--|---------------------------------|



14
PCS



6, 7, 8, 9, 10,
11, 12, 13, 14,
15, 16, 17, 18,
19mm



CHIAVI FISSE

12 CHIAVI

| | |
|-------------------|------------------|
| 51529 | 52973 |
| 48,50€ | 51,00€ |
| 2,63 | 2,50 |
| 5 | 2 |
| 165 | 8 |
| FINITURA SATINATA | FINITURA CROMATA |

12 PCS

6x7, 8x9, 10x11, 12x13, 14x15, 16x17, 18x19, 20x22, 21x23, 24x27, 25x28, 30x32mm



7 CHIAVI

| | |
|-------------------|------------------|
| 50561 | 52974 |
| 13,50€ | 17,00€ |
| 0,69 | 0,70 |
| 5 | 6 |
| 20 | 20 |
| 320 | 440 |
| FINITURA SATINATA | FINITURA CROMATA |

7 PCS

6x7, 8x9, 10x11, 12x13, 14x15, 16x17, 18x19mm



KIT DI CHIAVI POLIGONALI A GOMITO

12 CHIAVI

| | | | |
|---------------|------|---|-----|
| 50889 | 3,66 | 5 | 280 |
| 65,00€ | | | |

FINITURA SATINATA

| | | | | |
|---------------|------|---|---|-----|
| 52975 | 3,55 | 1 | 4 | 200 |
| 68,50€ | | | | |

FINITURA CROMATA



12 PCS

6x7, 8x9, 10x11, 12x13, 14x15, 16x17, 18x19, 20x22, 21x23, 24x27, 25x28, 30x32mm

7 CHIAVI

| | |
|-------------------|------------------|
| 50562 | 52976 |
| 18,50€ | 22,00€ |
| 0,87 | 1,20 |
| 20 | 2 |
| 500 | 12 |
| FINITURA SATINATA | FINITURA CROMATA |

FINITURA SATINATA

FINITURA CROMATA

7 PCS

6x7, 8x9, 10x11, 12x13, 14x15, 16x17, 18x19mm



SET DI 7 CHIAVI COMBinate A "S"

| | | | |
|---------------|------|----|-----|
| 50563 | 0,93 | 10 | 560 |
| 24,50€ | | | |



10, 11, 13, 14, 15, 17, 19mm

KIT 8 CHIAVI TIPO "C" POLIGONALI

| | | | |
|---------------|------|----|-----|
| 52451 | 0,93 | 20 | 300 |
| 34,00€ | | | |



6x7, 8x9, 10x11, 12x13, 14x15, 16x17, 18x19, 20x22mm

KIT DI 8 CHIAVI COMBinate CORTE

| | | | |
|---------------|------|----|-----|
| 50564 | 0,65 | 20 | 400 |
| 20,00€ | | | |



10, 11, 12, 13, 14, 15, 17, 19mm

KIT DI 6 CHIAVI SUPERLUNGHE

| | | | |
|---------------|------|----|-----|
| 51864 | 1,87 | 10 | 250 |
| 70,50€ | Kg | ff | ff |



10x11mm (290mmL),
12x14mm (330mmL),
13x15mm (368mmL),
16x18mm (407mmL),
17x19mm (407mmL),
22x24mm (430mmL)

▶ RICAMBI DISPONIBILI

| REF. | | Kg | ff | ff | € |
|-------|--------------|------|----|----|--------|
| 11244 | XL XZN 10x11 | 0,13 | 5 | | 13,00€ |
| 11245 | XL XZN 12x14 | 0,18 | 5 | | 15,50€ |
| 11246 | XL XZN 13x15 | 0,21 | 5 | | 18,00€ |
| 11247 | XL XZN 16x18 | 0,30 | 5 | | 21,50€ |
| 11248 | XL XZN 17x19 | 0,31 | 5 | | 20,00€ |
| 11249 | XL XZN 22x24 | 0,43 | 5 | | 28,00€ |



| | | | |
|---------------|------|----|-----|
| 52912 | 1,62 | 10 | 220 |
| 85,50€ | Kg | ff | ff |



E6xE7 (200mmL),
E8xE10 (235mmL),
E11xE12 (290mmL),
E14xE16 (370mmL),
E18xE20 (410mmL),
E22xE24 (420mmL)



KIT DI CHIAVI POLIGONALI A STELLA PIATTE

| | | | | |
|---------------|----|----|----|-----|
| 51878 | 1 | 5 | 10 | 240 |
| 45,50€ | Kg | ff | ff | ff |



6x7, 8x9, 10x11, 12x13, 14x15,
16x17, 18x19, 20x22mm

▶ RICAMBI DISPONIBILI

| REF. | | Kg | ff | ff | € |
|-------|-----------|------|----|----|--------|
| 11250 | XZN 6x7 | 0,04 | 5 | | 6,50€ |
| 11251 | XZN 8x9 | 0,04 | 5 | | 7,50€ |
| 11252 | XZN 10x11 | 0,07 | 5 | | 8,50€ |
| 11253 | XZN 12x13 | 0,07 | 5 | | 9,00€ |
| 11254 | XZN 14x15 | 0,09 | 5 | | 10,00€ |
| 11255 | XZN 16x17 | 0,12 | 5 | | 11,50€ |
| 11256 | XZN 18x19 | 0,16 | 5 | | 12,50€ |
| 11257 | XZN 20x22 | 0,23 | 5 | | 13,00€ |



KIT DI CHIAVI POLIGONALI PER RACCORDI

| | | | | |
|---------------|------|----|----|-----|
| 51879 | 0,74 | 5 | 20 | 480 |
| 35,00€ | Kg | ff | ff | ff |



10x11, 12x13, 14x15,
16x17, 18x19

▶ RICAMBI DISPONIBILI

| REF. | | Kg | ff | ff | € |
|-------|-----------|------|----|----|--------|
| 11258 | HEX 10x11 | 0,08 | 5 | | 11,50€ |
| 11259 | HEX 12x13 | 0,11 | 5 | | 12,50€ |
| 11260 | HEX 14x15 | 0,11 | 5 | | 14,00€ |
| 11261 | HEX 16x17 | 0,18 | 5 | | 15,00€ |
| 11262 | HEX 18x19 | 0,21 | 5 | | 15,50€ |



SET DI 8 CHIAVI A PIPA

| | | | |
|---------------|------|----|-----|
| 53420 | 1,50 | 20 | 540 |
| 62,50€ | Kg | ff | ff |



6x7, 8x9, 10x11, 12x13,
14x15, 16x17, 18x19, 20x22mm



SET DI 4 CHIAVI AD ANELLO TORX PIATTE IN SACCHETTO DI TELA

| | | | |
|---------------|------|----|-----|
| 51747 | 0,38 | 50 | 500 |
| 23,50€ | Kg | ff | ff |



6x8
10x12
14x18
20x24mm



KIT DI 14 CHIAVI A PIPA

| | | | |
|---------------|------|----|-----|
| 51528 | 3,55 | 5 | 280 |
| 32,00€ | Kg | ff | ff |



8, 9, 10, 11, 12, 13, 14, 15, 16,
17, 18, 19, 20, 21mm



SET DI 9 CHIAVI TORX A "L" DA 275mm

| | | | | |
|---------------|------|-----|----|-------|
| 52074 | 0,35 | 6 | 24 | 1.296 |
| 16,50€ | Kg | sub | ff | |



T10, T15, T20, T25, T27, T30, T40, T45, T50mm

SET DI 11 CHIAVI A BRUGOLA A "L" A TESTA A SFERA DA 275mm

| | | | | |
|---------------|------|-----|----|-----|
| 52073 | 0,81 | 6 | 24 | 846 |
| 16,50€ | Kg | sub | ff | |



A TESTA A SFERA DA 275mm
1,5, 2, 2,5, 3, 4, 5, 6, 7, 8, 10, 12mm

SET DI 10 CHIAVI A BRUGOLA

| | | | | |
|--------------|------|-----|----|-------|
| 50571 | 0,29 | 25 | 50 | 3.250 |
| 6,50€ | Kg | sub | ff | |



1,5, 2, 2,5, 3, 4, 5, 5,5, 6, 8, 10mm

SET DI 9 CACCIAVITI TORX A "T"

| | | | | |
|---------------|------|-----|----|-----|
| 51959 | 1,49 | 5 | 10 | 110 |
| 29,00€ | Kg | sub | ff | |

T10x100 T30x150
T15x100 T40x150
T20x100 T45x200
T25x150 T50x200mm
T27x150



SET DI 9 CHIAVI TORX A "T"

| | | | | |
|---------------|------|-----|----|-----|
| 52684 | 1,54 | 10 | 10 | 110 |
| 29,50€ | Kg | sub | ff | |

2, 2,5, 3, 4, 5, 6, 7, 8, 10mm

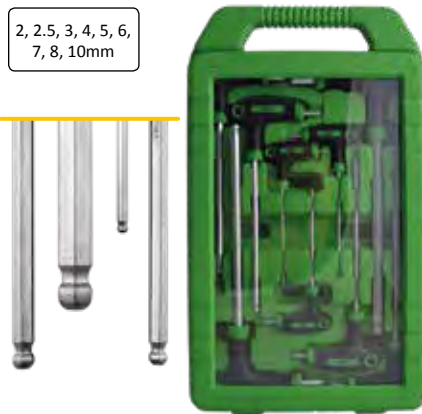

SET DI 8 CHIAVI ALLEN A "T"

| | | | |
|---------------|----|----|-----|
| 51954 | 1 | 10 | 100 |
| 27,00€ | Kg | ff | |

1, 2, 3, 4, 5, 6, 8, 10mm



STRUMENTI IN POLLICI

KIT DA 17 CHIAVI COMBinate IN POLLICI

17 PCS



FINITURA SATINATA

| | | | |
|---------------|------|----|-----|
| 51890 | 3,92 | 4 | 192 |
| 87,00€ | Kg | ff | |

FINITURA CROMATA

| | | | |
|---------------|------|----|--|
| 52972 | 4,60 | 4 | |
| 87,00€ | Kg | ff | |



5/16", 3/8", 7/16", 1/2", 9/16", 19/32", 5/8", 11/16", 3/4", 13/16", 7/8", 15/16", 1", 1-1/16", 1-1/8", 1-3/16", 1-1/4"



KIT DA 10 CHIAVI A BRUGOLA IN POLLICI



10 PCS

| | | | | |
|---------------|------|-----|----|-------|
| 51970 | 0,28 | 10 | 60 | 1.500 |
| 11,00€ | Kg | sub | ff | |

1/16", 5/64", 3/32", 1/8", 5/32", 3/16", 7/32", 1/4", 5/16", 3/8"



SET DI 8 CACCIAVITI

| | | | |
|---------------|------|----|-----|
| 52500 | 0,33 | 60 | 720 |
| 16,50€ | Kg | | |

| | | |
|-------|--|---|
| CORTE | | 0.4x2x25, 0.4x2.5x25, 0.5x3x.25, 0.5x3.5x25, 0.8x4x25 |
| | | PH00x25, PH0x25, PH1x25 |

| | | |
|--------|--|---|
| LUNGHE | | 0.4x2x75, 0.4x2.5x75, 0.5x3x.75, 0.5x3.5x75, 0.8x4x75 |
| | | PH00x75, PH0x75, PH1x75 |

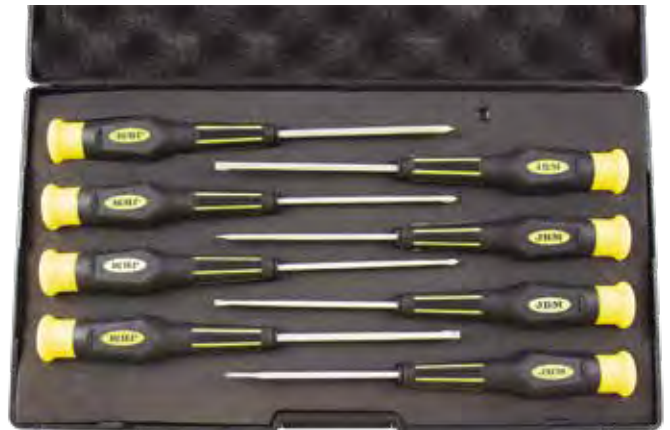

SET DI CACCIAVITI CON IMPUGNATURA INTERCambiabile

| | | | | |
|---------------|------|---|----|-----|
| 53010 | 0,72 | 5 | 20 | 600 |
| 16,50€ | Kg | | | |

11 PCS

| | |
|--|---|
| | H4x4mm, Testa a sfera H5x5mm, Testa a sfera H6x6mm, Testa a sfera |
|--|---|

| | |
|--|----------------|
| | 4x6mm 5x7mm |
|--|----------------|

| | | | |
|--|----------|--|----------------------------|
| | #1 #2 | | T10x15 T20x25 T30x40 |
|--|----------|--|----------------------------|



IMPUGNATURA MORBIDA

CACCIAVITE 6 IN 1

| | | | | |
|--------------|------|----|----|-------|
| 52072 | 0,19 | 12 | 72 | 1.728 |
| 5,50€ | Kg | | | |



Cr-V

| | |
|--|------------|
| | 5mm 6mm |
|--|------------|

| | |
|--|------------|
| | PH1 PH2 |
|--|------------|

| | |
|--|--------------|
| | n. 8 n. 9 |
|--|--------------|

CACCIAVITE REVERSIBILE A TAGLIO-STELLA

| | | | | |
|--------------|------|----|----|-------|
| 51955 | 0,11 | 24 | 96 | 1.344 |
| 4,00€ | Kg | | | |

| | | |
|---------|--|--|
| 6x150mm | | |
|---------|--|--|



| | | | | |
|--------------|------|----|----|-----|
| 52068 | 0,11 | 24 | 96 | 960 |
| 4,00€ | Kg | | | |

| | | |
|---------|--|--|
| 6x100mm | | |
|---------|--|--|



Acquistabile singolarmente o in espositore da 24 unità

SET DI 3 CACCIAVITI

| | | | | |
|---------------|------|---|----|-----|
| 51952 | 0,45 | 4 | 48 | 960 |
| 15,00€ | Kg | | | |

| | | | | |
|---------------|------|---|----|-----|
| 51953 | 0,44 | 4 | 48 | 960 |
| 15,00€ | Kg | | | |

| | | |
|--|-------------------------------|--|
| | 6x100mm 6x150mm 6x200mm | |
|--|-------------------------------|--|

| | | |
|--|-------------------------------|--|
| | 6x100mm 6x150mm 6x200mm | |
|--|-------------------------------|--|



KIT DI 12 CACCIAVITI A TAGLIO USO SCALPELLO

| | | | |
|---------------|------|---|-----|
| 52748 | 2,05 | 8 | 112 |
| 38,00€ | | | |



| | | |
|--|---------|-----------|
| | 6x38 | 3.2x75 |
| | 5x75 | 6x100 |
| | 8x150 | 9.5x200mm |
| | PH2x38 | PH0x75 |
| | PH1x75 | PH2x100 |
| | PH3x150 | PH4x200mm |
| | | |

GRIP DI GOMMA



KIT DI 4 CACCIAVITI A TAGLIO USO SCALPELLO

| | | | | |
|---------------|------|---|----|-----|
| 50902 | 0,65 | 6 | 24 | 600 |
| 13,00€ | | | | |

| | | |
|--|--|----------------|
| | | 3", 4", 6", 8" |
|--|--|----------------|



CACCIAVITE AD INSERTI

| | | | | |
|---------------|------|---|----|-----|
| 52325 | 0,85 | 6 | 24 | 768 |
| 13,50€ | | | | |

3/8"

| | | | |
|--|----------|--|----------------|
| | N.2, N.3 | | 5/16" 9/32" |
|--|----------|--|----------------|

Adattatore di 5/16"



CACCIAVITE FLESSIBILE

| | | | | |
|---------------|------|----|----|-----|
| 52170 | 0,27 | 12 | 48 | 672 |
| 15,50€ | | | | |

| | | |
|---------------------|------|--|
| | 1/4" | |
| 4, 5, 6, 7, 8, 10mm | | |



KIT DI 3 CACCIAVITI FLESSIBILI

| | | | | |
|---------------|------|----|----|-----|
| 52169 | 0,44 | 12 | 48 | 672 |
| 21,00€ | | | | |

| | |
|--|-----------|
| | 6, 7, 8mm |
| | |



CACCIAVITI CON MODULI EVA

| | | | | | | | |
|---------------|------|----|----|-----|--|---|------------------------------|
| 51378 | 0,81 | 10 | 30 | 240 | | PH4x200 PH3x150 PH2x100 PH2x38 | PH1x80 PH0x120 PH1x100 |
| 18,00€ | | | | | | | |

| | | | | | | | |
|---------------|-----|----|----|-----|--|---|------------------------------|
| 51380 | 0,8 | 10 | 30 | 240 | | 9x200mm 4x125mm 5x100mm 5x80mm | 6x38mm 6x100mm 8x150mm |
| 18,00€ | | | | | | | |

| | | | | | | | |
|---------------|------|----|----|-----|--|------------------------------------|------------------------------|
| 51381 | 0,55 | 10 | 30 | 240 | | T8x75 T9x75 T10x75 T15x75 | T20x75 T25x100 T27x100 |
| 13,50€ | | | | | | | |

| | | |
|-------|-------|------|
| 180mm | 380mm | 30mm |
|-------|-------|------|



CUTTER PROFESSIONALE

| | | | | | | |
|--------------|------|----|-----|-------|--|------|
| 51909 | 0,07 | 24 | 192 | 3.456 | | 10cm |
| 3,00€ | | | | | | |



Acquistabile singolarmente o in espositore da 24 unità

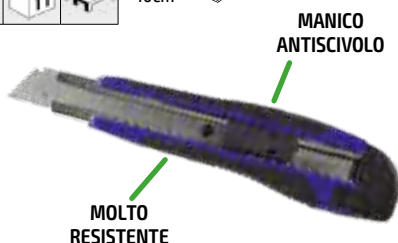

MOLTO RESISTENTE

MANICO ANTISCIVOLO

KIT CUTTER + LAME DI RICAMBIO

| | | | |
|---------------|------|----|-----|
| 51611 | 0,62 | 32 | 280 |
| 10,00€ | | | |



FORBICI PROFESSIONALI ASIMMETRICHE

| | | | | | | |
|--------------|------|----|-----|-------|--|-------|
| 51887 | 0,04 | 24 | 144 | 2.016 | | 200mm |
| 3,00€ | | | | | | |

Forbici in acciaio



Acquistabile singolarmente o in espositore da 24 unità



RESISTENTI E LEGGERE

MAGNETIZE / DEMAGNETIZE

| | | | | |
|--------------|------|----|----|-------|
| 53225 | 0,10 | 12 | 96 | 2.016 |
| 3,50€ | | | | |

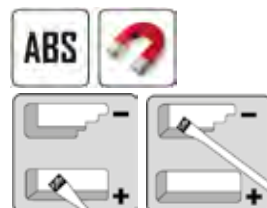

CHIAVE INGLESE

MOD. 1

| | | | | | | | |
|---------------|------|---|---|-----|-----|--|------|
| 51798 | 1,96 | 1 | 5 | 295 | 18" | | 53mm |
| 28,00€ | | | | | | | |
| 52424 | 3,64 | 1 | 5 | 175 | 24" | | 62mm |
| 60,50€ | | | | | | | |



MOD. 2

| | | | | | | | |
|---------------|------|---|-----|-------|-----|--|------|
| 51794 | 0,16 | 5 | 120 | 7.680 | 6" | | 18mm |
| 5,00€ | | | | | | | |
| 51795 | 0,28 | 6 | 120 | 3.600 | 8" | | 22mm |
| 7,50€ | | | | | | | |
| 51796 | 0,48 | 6 | 36 | 2.400 | 10" | | 28mm |
| 10,00€ | | | | | | | |
| 51797 | 0,71 | 6 | 48 | 1.200 | 12" | | 37mm |
| 13,50€ | | | | | | | |



MARTELLI PROFESSIONALI CON IMPUGNATURA IN GOMMA

| | | | | | | |
|---------------|------|-----|-----|-----|-----|---------|
| 52182 | 2,2 | 6 | 12 | 504 | 2Kg | ↔ 297mm |
| 20,50€ | Kg | 3x3 | ff | | | |
| 52184 | 4,31 | 4 | 128 | | 4Kg | ↔ 880mm |
| 43,50€ | Kg | ff | | | | |
| 52185 | 6,97 | 4 | 72 | | 6Kg | ↔ 895mm |
| 61,00€ | Kg | ff | | | | |
| 52186 | 8,68 | 2 | 60 | | 8Kg | ↔ 900mm |
| 75,00€ | Kg | ff | | | | |



MARTELLI

MARTELLI PUNTA DRITTA

| | | | | | |
|---------------|------|-----|----|-----|------|
| 51674 | 0,5 | 6 | 36 | 864 | 505g |
| 6,50€ | Kg | 3x3 | ff | | |
| 52565 | 1,13 | 6 | 24 | 720 | 1Kg |
| 10,00€ | Kg | 3x3 | ff | | |



MARTELLI PUNTA SFERICA

| | | | | | |
|---------------|------|-----|----|-------|------|
| 51918 | 1,34 | 6 | 18 | 432 | 1Kg |
| 10,50€ | Kg | 3x3 | ff | | |
| 51504 | 0,55 | 4 | 40 | 1.280 | 454g |
| 6,00€ | Kg | 3x3 | ff | | |

MARTELLI PROFESSIONALI ANTI-RIMBALZO

| | | | | | | |
|---------------|------|-----|----|-----|--------|---------|
| 52180 | 1,33 | 6 | 12 | 360 | 1,35Kg | ↔ 355mm |
| 18,00€ | Kg | 3x3 | ff | | | |
| 52181 | 1,81 | 6 | 12 | 300 | 1,80Kg | ↔ 370mm |
| 20,50€ | Kg | 3x3 | ff | | | |
| 52183 | 2,3 | 6 | 12 | 288 | 2,20Kg | ↔ 405mm |
| 29,00€ | Kg | 3x3 | ff | | | |



MARTELLI NYLON ANTI-RIMBALZO

| | | | | | |
|---------------|------|-----|----|-----|--------|
| 52425 | 0,7 | 6 | 12 | 500 | ∅ 40mm |
| 26,50€ | Kg | 3x3 | ff | | |
| 52426 | 1,68 | 2 | 12 | 180 | ∅ 60mm |
| 48,00€ | Kg | 3x3 | ff | | |
| 52427 | 2,02 | 2 | 12 | 204 | ∅ 70mm |
| 60,00€ | Kg | 3x3 | ff | | |



PUNTA DI RICAMBIO

| REF. | ∅ | Kg | ff | € |
|-------|--------|------|----|--------|
| 11212 | ∅ 40mm | 0,02 | 6 | 5,00€ |
| 11213 | ∅ 60mm | 0,08 | 6 | 10,50€ |
| 11214 | ∅ 70mm | 0,11 | 6 | 12,50€ |



ASCIA CON MANICO IN LEGNO

| | | | | | |
|---------------|------|---|----|-----|-------|
| 52188 | 0,82 | 4 | 24 | 875 | 360mm |
| 12,00€ | Kg | | | | |

| | | | | | |
|---------------|------|---|----|-----|-------|
| 52460 | 1,17 | 4 | 24 | 864 | 410mm |
| 13,00€ | Kg | | | | |

| | | | | | |
|---------------|----|---|----|-----|-------|
| 52461 | 2 | 4 | 12 | 432 | 700mm |
| 21,00€ | Kg | | | | |



SEGA AD ARCO

| | | | | | |
|--------------|------|----|----|-----|-------|
| 51675 | 0,26 | 10 | 48 | 720 | 430mm |
| 7,00€ | Kg | | | | |

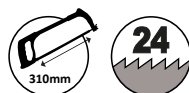
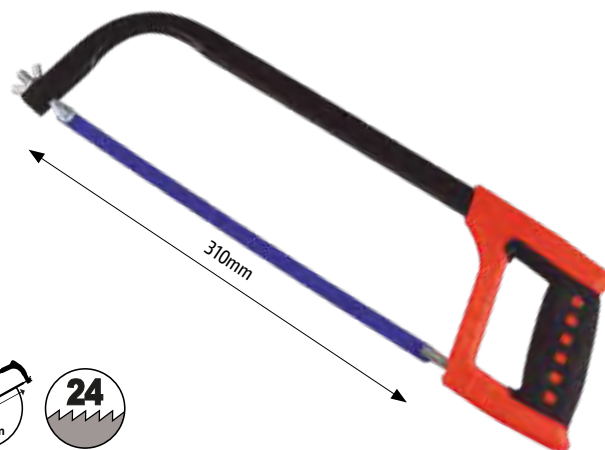

SEGHETTO CON MANICO ERGONOMICO

| |
|---------------|
| 52830 |
| 22,50€ |

| | |
|----|------|
| Kg | 0,63 |
| | 10 |
| | 20 |
| | 780 |

| |
|-------|
| 300mm |
| 12" |



SEGHETTO

| |
|---------------|
| 52831 |
| 15,50€ |

| | |
|----|------|
| Kg | 0,49 |
| | 10 |
| | 20 |
| | 480 |

| |
|-------|
| 300mm |
| 12" |

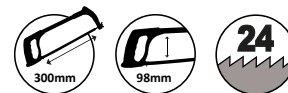
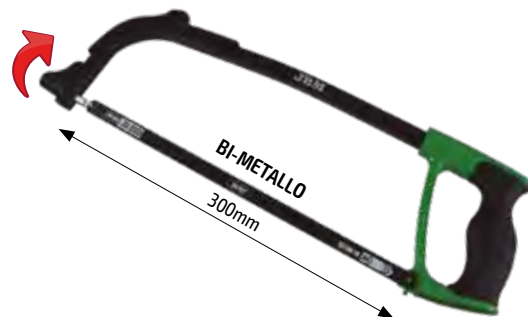

Acquistabile singolarmente o in espositore da 10 unità

LAMA PER SEGHETTO REF.52830 E 52831



| | | | |
|--------------|------|----|-----|
| 12060 | 0,02 | 10 | 100 |
| 2,00€ | Kg | | |



Acquistabile singolarmente o in espositore da 10 unità

SET DI 5 PUNZONI CONICI

| |
|---------------|
| 52049 |
| 11,00€ |

| | |
|----|-------|
| Kg | 0,43 |
| | 10 |
| | 40 |
| | 3.840 |

| |
|-----------------|
| 3, 4, 5, 6, 7mm |
|-----------------|



SET DI 5 PUNZONI

| |
|---------------|
| 52013 |
| 10,50€ |

| | |
|----|-------|
| Kg | 0,38 |
| | 10 |
| | 40 |
| | 3.840 |

| |
|-----------------|
| 4, 5, 6, 7, 8mm |
|-----------------|



SET DI 6 PUNZONI

| |
|---------------|
| 53095 |
| 15,50€ |

| | |
|----|-----|
| Kg | 0,8 |
| | 6 |
| | 24 |

| |
|----------------------|
| ∅ 3, 4, 5, 6, 7, 8mm |
|----------------------|

| |
|-------|
| 150mm |
|-------|



SCALPELLI

| | | | | |
|--------------|------|-----|----|-------|
| 53120 | 0,56 | 6 | 24 | |
| 4,50€ | Kg | sub | ff | 150mm |

| | | | | |
|--------------|------|-----|----|-------|
| 53121 | 0,55 | 6 | 24 | 720 |
| 5,50€ | Kg | sub | ff | 250mm |

| | | | | |
|--------------|-----|-----|----|-------|
| 53122 | 0,9 | 6 | 12 | 432 |
| 7,00€ | Kg | sub | ff | 350mm |



SET DI 4 SCALPELLI

| | | | | |
|---------------|------|-----|----|--|
| 53083 | 1,09 | 10 | 20 | |
| 48,50€ | Kg | sub | ff | |

18x125mm, 21x150mm,
26x200mm, 29x250mm



SET DI 5 SCALPELLI

| | | | | |
|---------------|------|-----|----|-------|
| 52014 | 0,47 | 10 | 40 | 3.840 |
| 13,50€ | Kg | sub | ff | |

10, 11, 12, 14, 16mm



SET DI 3 SPATOLE IN ACCIAIO

| | | | | |
|---------------|------|----|-----|--|
| 51951 | 0,42 | 15 | 360 | |
| 17,50€ | Kg | ff | ff | |

Dopo ergonomico: 40, 60, 80mm



KIT DI 4 SPATOLE DI ACCIAIO

| | | | | |
|--------------|------|-----|----|-----|
| 53339 | 0,25 | 10 | 40 | 480 |
| 8,50€ | Kg | sub | ff | ff |

2, 3, 4, 6"



SET DI 5 LIME IN ACCIAIO

| | | | | |
|---------------|------|----|-----|--|
| 51853 | 0,89 | 20 | 480 | |
| 15,50€ | Kg | ff | ff | |

310mm

8"



RIVETTATRICE 10"

| | | | | |
|---------------|------|-----|----|-----|
| 53331 | 0,80 | 5 | 20 | 280 |
| 28,50€ | Kg | sub | ff | ff |

250mm

10"



| |
|--------------|
| |
| 2,4mm (3/32) |
| 3,2mm (1/8) |
| 4,0mm (5/32) |
| 4,8mm (3/16) |
| 6,4mm (1/4) |

RIVETTATRICE ESTENSIBILE 8"

| | | | | |
|---------------|------|-----|----|-----|
| 53332 | 1,65 | 5 | 10 | 280 |
| 31,00€ | Kg | sub | ff | ff |

200mm

8"

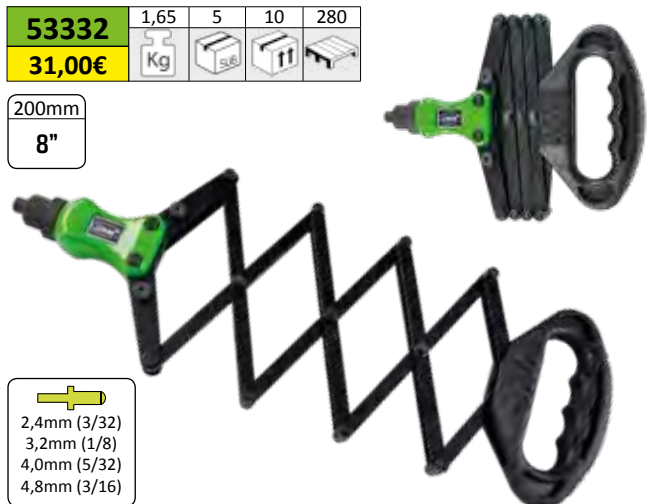

| |
|--------------|
| |
| 2,4mm (3/32) |
| 3,2mm (1/8) |
| 4,0mm (5/32) |
| 4,8mm (3/16) |

RIVETTATRICE COMPATTA 200MM / 8"

52595

55,00€

1,30

10

140

200mm
8"

M3, M4,
M5, M6



RIVETTATRICE COMPATTA 200MM / 8"

52462

23,50€

0,56

5

30

900

200mm
8"

2,4mm (3/32)
3,2mm (1/8)
4,0mm (5/32)
4,8mm (3/16)



RIVETTATRICE 300MM / 12"

52463

22,00€

0,74

20

280

300mm
12"

3,2mm (1/8)
4,0mm (5/32)
4,8mm (3/16)



RIVETTATRICE 400MM / 16"

52464

40,50€

0,68

5

10

210

400mm
16"

2,4mm (3/32)
3,2mm (1/8)
4,0mm (5/32)
4,8mm (3/16)
6,4mm (1/4)



RIVETTATRICE 400MM / 16"

52596

104,50€

3,07

5

75

400mm
16"

M3, M4, M5, M6,
M8, M10, M12



RIVETTATRICE AUTOMATICA 440MM / 17"

52597

126,00€

3,25

5

80

440mm
17"

M3, M4,
M5, M6, M8,
M10, M12

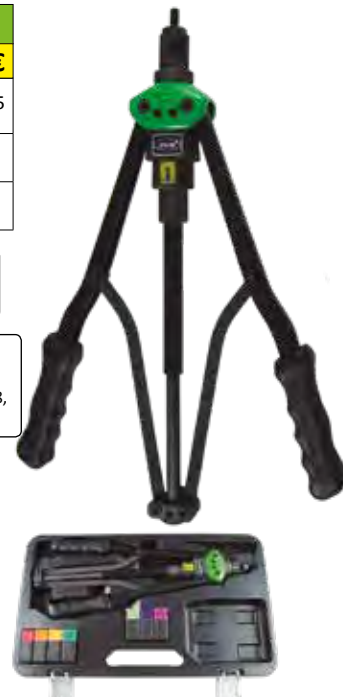

RIVETTATRICE + SET DI RIVETTI IN PLASTICA

52609

30,50€

0,50 10 20 240

10 u. Ø 6,6mm x 17,2mm
10 u. Ø 6,3mm x 25,2mm
10 u. Ø 5mm x 17,2mm
10 u. Ø 5mm x 15,8mm



RIVETTI IN PLASTICA

| REF. | DESCRIZIONE | | | | € |
|-------|-------------|------|----|--|-------|
| 13674 | 6 x 19,3mm | 0,01 | 25 | | 0,40€ |
| 13675 | 6 x 17,8mm | 0,01 | 25 | | 0,40€ |
| 13676 | 6 x 25,5mm | 0,01 | 25 | | 0,40€ |
| 13677 | 6 x 24,5mm | 0,01 | 25 | | 0,40€ |
| 13678 | 6 x 24mm | 0,01 | 25 | | 0,40€ |

RIVETTATRICE PNEUMATICA

52575

94,00€

1,71 10 200

2,4mm (3/32), 3,2mm (1/8)
4,0mm (5/32), 4,8mm (3/16)

Trazione: 1586LBS / 720 KGS
ROD: 9/16" - 14MM
Coppia max. 60ft-20-IB / 23-69M
Aria: 1/4"
Tubo 3/8"
Conduco medio di aria:
0.03CFM/0.86L/MIN
Flusso ottimale: 1,5 HP

Comprende:
2 MULTI-TOOL
VELOCE
O-RING



ASTUCCIO DI RICETTI DISPONIBILE PAG 247

CRICCHETTO 72 DENTI CON SET DI INSERTI



| | | | | |
|---------------|-----|-----|----|-----|
| 52948 | 1,2 | 4 | 24 | 384 |
| 27,50€ | Kg | Sub | ff | |

1/2" 10, 11, 12, 13, 14, 15,
16, 17, 18, 19mm

| | | | | |
|---------------|------|-----|----|-----|
| 52950 | 0,35 | 6 | 36 | 864 |
| 16,00€ | Kg | Sub | ff | |

1/4" 4, 5, 6, 7, 8, 9, 10,
11, 12, 13mm



| | | | | |
|---------------|------|-----|----|-----|
| 52949 | 1,22 | 4 | 24 | 384 |
| 27,50€ | Kg | Sub | ff | |

1/2" 10, 11, 12, 13, 14, 15,
16, 17, 18, 19mm

| | | | | |
|---------------|------|-----|----|-----|
| 52951 | 0,34 | 6 | 36 | 864 |
| 16,00€ | Kg | Sub | ff | |

1/4" 4, 5, 6, 7, 8, 9, 10,
11, 12, 13mm



CRICCHETTO A 72 DENTI

FINITURA CROMATA

| | | | |
|---------------|------|-----|----|
| 53098 | 0,15 | 12 | 36 |
| 14,50€ | Kg | Sub | ff |

1/4" 145mm

| | | | |
|---------------|------|-----|----|
| 53099 | 0,29 | 12 | 24 |
| 16,50€ | Kg | Sub | ff |

3/8" 200mm

| | | | |
|---------------|------|-----|----|
| 53100 | 0,59 | 12 | 24 |
| 20,00€ | Kg | Sub | ff |

1/2" 255mm



Acquistabile singolarmente o
in espositore da 12 unità



FINITURA SATINATA

| | | | | |
|---------------|------|-----|----|-------|
| 51382 | 0,15 | 12 | 36 | 1.008 |
| 13,50€ | Kg | Sub | ff | |

1/4" 145mm

| | | | |
|---------------|------|-----|----|
| 51270 | 0,28 | 12 | 24 |
| 15,50€ | Kg | Sub | ff |

3/8" 200mm

| | | | | |
|---------------|-----|-----|----|-----|
| 51921 | 0,6 | 12 | 24 | 960 |
| 20,00€ | Kg | Sub | ff | |

1/2" 255mm



Acquistabile singolarmente o
in espositore da 12 unità



CRICCHETTO A 24 DENTI FINITURA SATTINATA

| | | | | |
|---------------|------|-----|----|-------|
| 51285 | 0,15 | 12 | 36 | 2.592 |
| 12,50€ | Kg | Sub | ff | |

1/4" 155mm

| | | | | |
|---------------|------|-----|----|-----|
| 51286 | 0,35 | 12 | 36 | 600 |
| 12,50€ | Kg | Sub | ff | |

3/8" 210mm

| | | | | |
|---------------|------|-----|----|-----|
| 51287 | 0,55 | 12 | 24 | 960 |
| 14,50€ | Kg | Sub | ff | |

1/2" 260mm



Acquistabile singolarmente o
in espositore da 12 unità



CRICCHETTO A 72 DENTI FINITURA SATTINATA

| | | | | |
|---------------|------|-----|-----|-------|
| 52207 | 0,05 | 12 | 240 | 8.400 |
| 16,50€ | Kg | Sub | ff | |

1/4" 85mm



Acquistabile singolarmente o
in espositore da 12 unità



CRICCHETTO 72 DENTI ARTICOLATO CORTO

| | | | | | | |
|---------------|------|----|-----|-------|------|-------|
| 52587 | 0,16 | 12 | 144 | 3.456 | 1/4" | 175mm |
| 30,00€ | Kg | | | | | |

| | | | | | | |
|---------------|------|----|-----|-------|------|-------|
| 52588 | 0,17 | 12 | 144 | 3.456 | 1/2" | 175mm |
| 30,50€ | Kg | | | | | |



Acquistabile singolarmente
o in espositore da 12 unità

| | | | | | | |
|---------------|------|----|----|-----|------|-------|
| 51305 | 0,31 | 12 | 48 | 816 | 1/2" | 175mm |
| 18,00€ | Kg | | | | | |

| | | | | | | |
|---------------|------|----|----|-----|------|-------|
| 51306 | 0,30 | 12 | 48 | 816 | 1/4" | 175mm |
| 15,50€ | Kg | | | | | |



Acquistabile singolarmente
o in espositore da 12 unità

CRICCHETTO 72 DENTI CON TESTA ROTANTE

| | | | | | | |
|---------------|------|----|----|-------|------|-------|
| 51405 | 0,15 | 12 | 48 | 1.008 | 1/4" | 145mm |
| 22,50€ | Kg | | | | | |

| | | | | | | |
|---------------|------|----|----|-----|------|-------|
| 51406 | 0,66 | 12 | 24 | 960 | 1/2" | 280mm |
| 32,50€ | Kg | | | | | |



Acquistabile
singolarmente o
in espositore da
12 unità

CRICCHETTO 48 DENTI CON TESTA ROTANTE

| | | | | | | |
|---------------|------|----|----|-------|------|-------|
| 52585 | 0,15 | 12 | 72 | 2.160 | 1/4" | 185mm |
| 32,50€ | Kg | | | | | |

| | | | | | | |
|---------------|------|----|----|-----|------|-------|
| 52586 | 0,73 | 12 | 24 | 768 | 1/2" | 310mm |
| 40,00€ | Kg | | | | | |



Acquistabile singolarmente
o in espositore da 12 unità

CRICCHETTO ARTICOLATO 72 DENTI

| | | | | |
|---------------|------|---|----|--|
| 53346 | 0,25 | 6 | 12 | |
| 18,00€ | Kg | | | |

1/4" 16,5 - 21,5cm

| | | | | |
|---------------|------|---|----|-----|
| 51307 | 0,92 | 6 | 12 | 540 |
| 33,00€ | Kg | | | |

1/2" 30,5 - 44,5cm

Acciaio forgiato con
trattamento termico

IMPUGNATURA
ERGONOMICA E ESTENSIBILE

ESTENSIBILE



Acquistabile
singolarmente o in
espositore da 6 unità



Acquistabile
singolarmente o in
espositore da 6 unità

CRICCHETTO ARTICOLATO ESTENSIBILE DA 1/2" A 72 DENTI

| | | | | |
|---------------|----|------|---|----|
| 52197 | | | | |
| 46,00€ | Kg | 1,04 | 6 | 12 |

| | |
|--|-----|
| | 480 |
|--|-----|

350-490mm
1/2"

ROTAZIONE
DI 180°

ESTENSIBILE



Acquistabile
singolarmente o in
espositore da 6 unità

CRICCHETTO FLESSIBILE 72 DENTI DA 3/8"

| | | | | |
|---------------|------|----|-----|-------|
| 51801 | 0,57 | 40 | 160 | 500mm |
| 63,00€ | Kg | | | |
| | | | | 3/8" |

Molto utile per luoghi di difficile accesso.



CHIAVE A CROCE FISSATA MECCANICAMENTE

| | | | | |
|---------------|------|---|----|-----|
| 51661 | 1,17 | 5 | 20 | 480 |
| 10,00€ | Kg | | | |

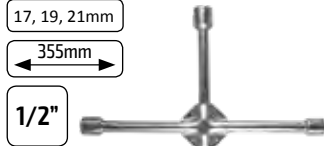

| | | | |
|---------------|-----|----|-----|
| 52881 | 1,4 | 10 | 420 |
| 13,50€ | Kg | | |

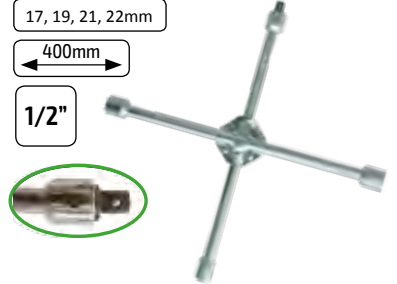

| | | | |
|---------------|------|---|-----|
| 52880 | 3,75 | 5 | 100 |
| 27,50€ | Kg | | |

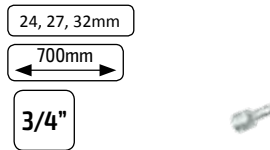

ADATTATORE PER TESTE

N

| | | | | | | |
|--------------|-----|---|-----|-----|-------|--|
| 53478 | 0,5 | 5 | 100 | 700 | 115mm | |
| 4,50€ | Kg | | | | 1/4" | |

| | | | | | | |
|--------------|------|---|----|-----|-------|--|
| 53479 | 0,15 | 5 | 50 | 300 | 200mm | |
| 6,00€ | Kg | | | | 3/8" | |

| | | | | | | |
|--------------|------|---|----|-------|------|--|
| 53468 | 0,35 | 5 | 30 | 250mm | | |
| 9,00€ | Kg | | | | 1/2" | |

| | | | | | | |
|---------------|------|---|----|-----|-------|--|
| 53480 | 1,35 | 5 | 10 | 300 | 460mm | |
| 21,50€ | Kg | | | | 3/4" | |

| | | | | | | |
|---------------|------|---|-----|-------|----|--|
| 53481 | 2,85 | 5 | 300 | 550mm | | |
| 32,50€ | Kg | | | | 1" | |

CrMo



CHIAVI LUNGHE SNODATE

| | | | | | | |
|---------------|------|---|---|-----|------|--|
| 52524 | 3,65 | 3 | 6 | 192 | 3/4" | |
| 48,00€ | Kg | | | | | |

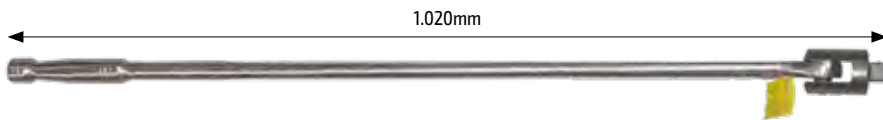

| | | | | | | |
|---------------|------|---|----|-----|------|--|
| 52526 | 1,83 | 5 | 10 | 500 | 1/2" | |
| 25,50€ | Kg | | | | | |

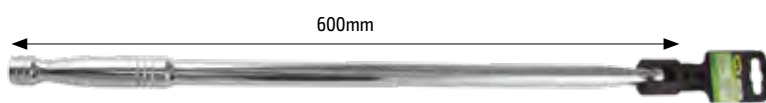

| | | | | | | |
|---------------|------|----|----|-------|------|--|
| 52525 | 0,78 | 10 | 20 | 1.920 | 1/2" | |
| 12,50€ | Kg | | | | | |

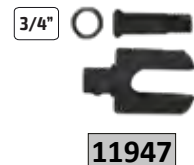

| REF. | " | PER | | | | € |
|-------|------|-------|------|----|-----|-------|
| 11947 | 3/4" | 52524 | 0,01 | - | 60 | 6,50€ |
| 11945 | 1/2" | 52526 | 0,2 | 25 | 100 | 6,00€ |
| 11946 | 1/2" | 52525 | 0,06 | - | 300 | 3,50€ |

SET DI PROLUNGHE DA 1/2" CON TESTA A SFERA

| | | | | | |
|---------------|------|---|-----|------|--|
| 51448 | 2,38 | 5 | 280 | 1/2" | |
| 53,50€ | Kg | | | | |

50, 125, 250, 380, 510mm



SET DI PROLUNGHE DA 1/4"

| | | | | | |
|---------------|------|----|-------|------|--|
| 51447 | 0,34 | 20 | 1.000 | 1/4" | |
| 13,50€ | Kg | | | | |

50, 75, 100, 152, 227mm

| | | | | | |
|---------------|------|----|-------|------|--|
| 51805 | 0,34 | 20 | 1.000 | 1/4" | |
| 16,50€ | Kg | | | | |

50, 75, 100, 152, 227mm



PROLUNGA TELESCOPICA DA 1/2" CON TESTA A SFERA

| | | | | | | |
|---------------|------|----|----|-------|-----------|------|
| 51479 | 0,65 | 12 | 24 | 1.056 | 260-410mm | 1/2" |
| 28,50€ | Kg | | | | | |



Acquistabile singolarmente o in espositore da 12 unità



PROLUNGA FLESSIBILE CON PUNTA A 4 ARTIGLI

| | | | | |
|--------------|------|----|-----|-------|
| 51526 | 0,09 | 12 | 144 | 1.728 |
| 7,50€ | Kg | | | |

500mm 20mm

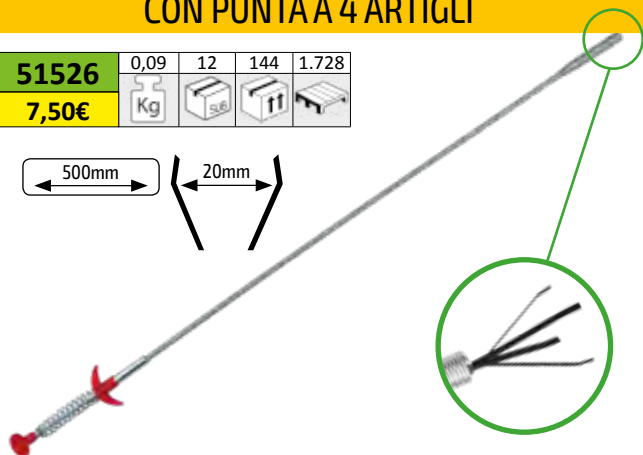

PROLUNGA FLESSIBILE MAGNETICA CON LED

| | | | | | |
|--------------|------|----|----|-----|--|
| 52473 | 0,18 | 10 | 60 | 900 | |
| 7,00€ | Kg | | | | |

545mm



PROLUNGA TELESCOPICA TIPO "ANTENA" CON PUNTA MAGNETICA

| | | | | | |
|--------------|------|----|-----|-------|--|
| 52472 | 0,04 | 12 | 108 | 4.320 | |
| 4,00€ | Kg | | | | |

135-600mm

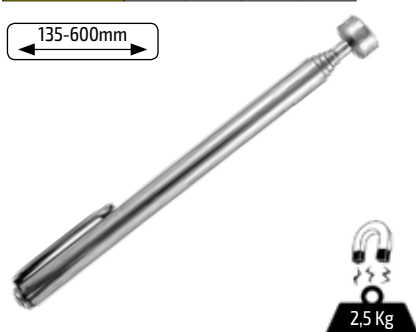

PROLUNGA FLESSIBILE CON PUNTA MAGNETICA

| | | | | | |
|--------------|------|----|----|-------|--|
| 51525 | 0,14 | 10 | 60 | 1.440 | |
| 7,50€ | Kg | | | | |



SPECCHIETTO DI ISPEZIONE TELESCOPICO CON LED

| | | | | |
|--------------|------|----|----|-------|
| 51272 | 0,08 | 12 | 72 | 1.440 |
| 7,50€ | Kg | | | |

90-810mm



Acquistabile singolarmente o in espositore da 12 unità

SPECCHIETTO DI ISPEZIONE TELESCOPICO

| | | | | |
|--------------|------|----|----|-------|
| 52468 | 0,09 | 12 | 48 | 2.688 |
| 5,50€ | Kg | | | |

280-445mm



Ø 50mm

COLTELLO TAGLIA CINTURE DA SICUREZZA E PUNTA FRANGICRISTALLO

| | | | | | | |
|---------------|------|----|----|-------|--|--|
| 52786 | 0,16 | 12 | 60 | 2.100 | | |
| 12,50€ | Kg | | | | | |



Acquistabile singolarmente o in espositore da 12 unità



ATTREZZI CURVATUBI 6-8-10mm

| | | | | | | |
|---------------|------|---|----|--|------------|--|
| 52905 | 0,51 | 6 | 24 | | 6, 8, 10mm | |
| 31,00€ | Kg | | | | | |

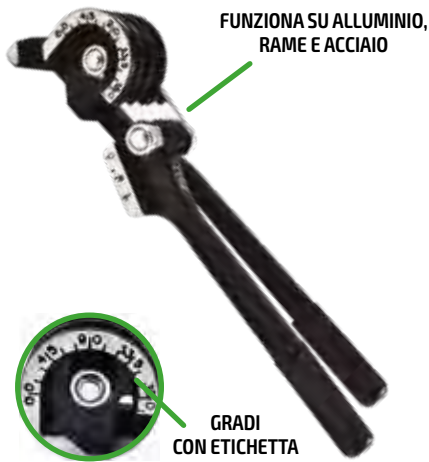

TAGLIATUBI

| | | | | | | |
|--------------|------|----|----|-----|--|--|
| 53517 | 0,13 | 10 | 60 | 600 | | |
| 8,00€ | Kg | | | | | |

Ø max: 30mm



| | |
|---------------|---------------|
| 52878 | 52879 |
| 12,50€ | 12,50€ |

| | | | |
|----|-------|----|-------|
| Kg | 0,22 | Kg | 0,24 |
| | 10 | | 10 |
| | 50 | | 50 |
| | 1.500 | | 1.500 |

3-32mm

3-35mm



52878

52879

| REF. | DESCRIZIONE | PER | Kg | € |
|-------|------------------|-------|------|-------|
| 12964 | Ruota in acciaio | 52878 | 0,01 | 2,00€ |
| 12965 | Ruota in acciaio | 52879 | 0,01 | 2,00€ |

FORBICI TAGLIATUBI

| | | | | | | |
|---------------|------|----|-----|--|------|--------|
| 52877 | 0,43 | 48 | 720 | | 42mm | 1-5/8" |
| 14,50€ | Kg | | | | | |



PINZA SPELLAFILI AUTOREGOLABILE

| | | | | | | |
|---------------|------|----|-----|-----|--|--|
| 51972 | 0,25 | 10 | 100 | 800 | | |
| 12,00€ | Kg | | | | | |

0,08-6mm

Per spellare cavi elettrici con rivestimento in plastica o caucciù, singoli o multipli, con sezione da 0,08 a 6 mm². Regolazione automatica dello spessore di spellamento per le diverse sezioni. Nei cavi di rame o d'alluminio permette di spellare contemporaneamente diversi cavi, con una sezione massima di 6 mm². Permette di pelare un solo cavo a partire da 0,08 mm² di sezione. Non danneggia il filo conduttore; alta durabilità.



FORBICI TAGLIACAVI ISOLATE ELETTRICAMENTE

| | | | | | | |
|---------------|------|----|-----|-------|--|--|
| 52152 | 0,08 | 12 | 120 | 1.440 | | |
| 11,50€ | Kg | | | | | |

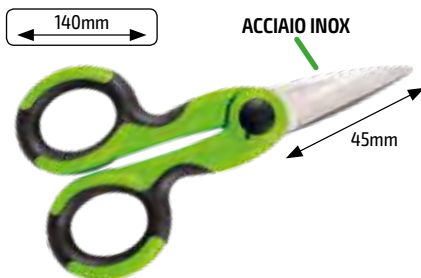

TENAGLIE SPELLAFILI

| | | | | | |
|--------------|------|----|-----|--|--|
| 53411 | 0,05 | 12 | 120 | | |
| 4,00€ | Kg | | | | |

127mm



| | | | | | |
|--------------|------|----|-----|--|--|
| 53412 | 0,05 | 12 | 120 | | |
| 3,00€ | Kg | | | | |

94mm



PINZA RIPIEGABILE MULTIUSO CON INSERTI INCLUSI

| | | | | |
|---------------|------|-----|----|-------|
| 52411 | 0,37 | 12 | 48 | 2.880 |
| 18,00€ | Kg | sub | ff | |

180mm

- 1 x cacciaviti stella
- 2 x opener
- 3 x cacciaviti a taglio
- 1 x visto con nastro adesivo
- 1 x 35mm taglio di lamiera
- 1 x 65mm taglio di lamiera
- 1 x adattatore 1/4"
- 9 x punta cacciaviti:
- 1 x HEX 3mm, 1 X HEX 4mm,
- 1 x HEX 5mm, 1 x taglio 4mm,
- 1 x taglio 5mm, 1 x taglio 6mm,
- 1 x PH1, 1 X PH2, 1 X PH3



PINZA MINI RIPIEGABILE MULTIUSO

| | | | | |
|--------------|------|-----|-----|-------|
| 52412 | 0,09 | 24 | 144 | 5.760 |
| 5,50€ | Kg | sub | ff | |

105mm

- 2 x cacciaviti
- 1 x lima 25mm
- 1 x bottiglia apribottiglia
- 1 x opener
- 1 x 40mm lama
- 1 x punta stella
- 1 x line-cut 40mm



PINZA PER CAPICORDA

PER CAPICORDA ISOLATI E NON ISOLATI

| | | | | |
|--------------|------|-----|----|-------|
| 52761 | 0,25 | 12 | 72 | 1.296 |
| 8,00€ | Kg | sub | ff | |

9"



PER CAPICORDA NON ISOLATI

| | | | | |
|--------------|------|-----|----|-------|
| 52762 | 0,25 | 12 | 72 | 1.296 |
| 8,50€ | Kg | sub | ff | |

8 - 3/4"



SET DI PINZE PIATTE PER SCOLLEGARE TUBO DEL CARBURANTE

| | | | | |
|---------------|------|-----|----|-----|
| 53445 | 0,35 | 12 | 48 | 384 |
| 12,50€ | Kg | sub | ff | |



PINZA PER RIMOZIONE RIVETTI

| | | | | |
|---------------|------|-----|----|-----|
| 53385 | 0,15 | 6 | 54 | 499 |
| 16,00€ | Kg | sub | ff | |



TAGLIO



ESTRATTO



BRIGLIA



PUNTA ANGOATA:
Progettato per estrarre / tagliare graffette / clip facilmente e senza danni.
Consente un facile accesso alle aree ristrette.

SET DI 3 PINZE PUNTA DA 0°, 45°, 90°

| | |
|---------------|------|
| 52272 | |
| 25,50€ | |
| Kg | 1,00 |
| sub | 5 |
| ff | 20 |
| | 280 |

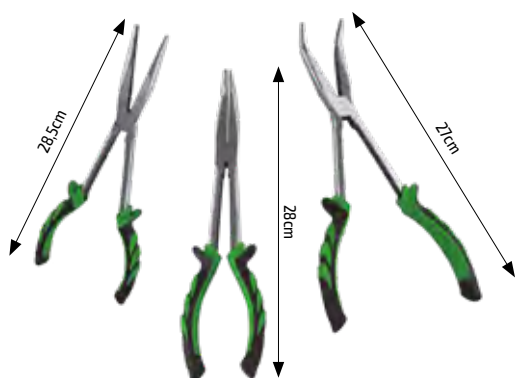

SET DI 5 PINZE IN ASTUCCIO

| | | | | |
|---------------|------|-----|----|-----|
| 51812 | 1,45 | 5 | 10 | 240 |
| 32,00€ | Kg | sub | ff | |

180mm 160mm 200mm



160mm 250mm



PINZE SEGER - BECCHI DIRITTI

INTERNI

| | | | | | | | |
|---------------|------|---|-----|-------|------------|-------|------------|
| 53549 | 0,4 | 5 | 30 | | 13" | 330mm | CrV |
| 15,00€ | Kg | 5 | 30 | | | | |
| 52964 | 0,23 | 6 | 60 | 1.260 | 9" | 225mm | CrV |
| 10,00€ | Kg | 6 | 60 | 1.260 | | | |
| 51018 | 0,15 | 5 | 100 | 1.400 | 7" | 180mm | CrV |
| 6,50€ | Kg | 5 | 100 | 1.400 | | | |

ESTERNI

| | | | | | | | |
|---------------|------|---|-----|-------|------------|-------|------------|
| 53547 | 0,4 | 5 | 30 | | 13" | 330mm | CrV |
| 15,00€ | Kg | 5 | 30 | | | | |
| 52966 | 0,25 | 6 | 60 | 1.440 | 9" | 225mm | CrV |
| 10,00€ | Kg | 6 | 60 | 1.440 | | | |
| 51017 | 0,13 | 5 | 100 | 1.400 | 7" | 180mm | CrV |
| 6,50€ | Kg | 5 | 100 | 1.400 | | | |



PINZE SEGER BOCA CURVA

INTERNI

| | | | | | | | |
|---------------|------|----|-----|-------|------------|-------|------------|
| 53550 | 0,4 | 5 | 30 | | 13" | 330mm | CrV |
| 15,00€ | Kg | 5 | 30 | | | | |
| 52965 | 0,24 | 6 | 60 | 1.440 | 9" | 225mm | CrV |
| 10,00€ | Kg | 6 | 60 | 1.440 | | | |
| 51021 | 0,16 | 10 | 100 | 1.400 | 7" | 180mm | CrV |
| 6,50€ | Kg | 10 | 100 | 1.400 | | | |

ESTERNI

| | | | | | | | |
|---------------|------|----|-----|-------|------------|-------|------------|
| 53548 | 0,4 | 5 | 30 | | 13" | 330mm | CrV |
| 10,00€ | Kg | 5 | 30 | | | | |
| 52967 | 0,24 | 6 | 60 | 1.440 | 9" | 225mm | CrV |
| 10,00€ | Kg | 6 | 60 | 1.440 | | | |
| 51020 | 0,13 | 10 | 100 | 1.400 | 7" | 180mm | CrV |
| 6,50€ | Kg | 10 | 100 | 1.400 | | | |



SET DI PINZE SEGER CON PUNTA INTERCAMBIABILE

| | | | | | | | |
|---------------|-----|----|-----|--|------------|---------------|---------------------------------------|
| 53389 | 1,5 | 10 | 160 | | 10" | 26 PCS | Angolo puntas 90° / 45° / 15° / 0° |
| 25,00€ | Kg | 10 | 160 | | | | |

Contiene:
pinze interne, pinze esterne, 16 punte di
diversi angoli, 8 bulloni.



KIT DI 3 PINZE AUTOBLOCCANTE SUPERLUNGHE

| | | | | | |
|---------------|-----|---|---|-----|--|
| 52982 | 1,6 | 4 | 8 | 400 | |
| 47,00€ | Kg | 4 | 8 | 400 | |

37cm: punta diritta
36cm: angolo di 45°
34cm: angolo di 90°

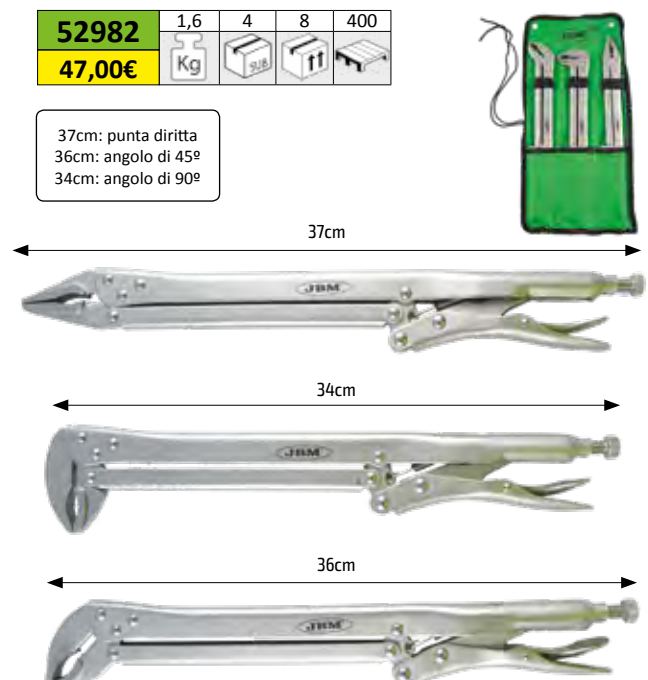

PINZA EXTRA-LUNGA

DIRITTA

| | | | | |
|---------------|-----|----|-------|--|
| 52846 | 0,4 | 60 | 1.500 | |
| 42,00€ | | | | |

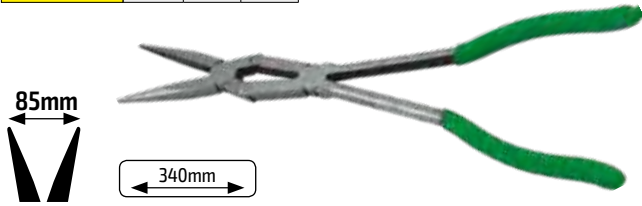

CURVA 45°

| | | | | |
|---------------|-----|----|-------|--|
| 52847 | 0,4 | 60 | 1.500 | |
| 42,00€ | | | | |

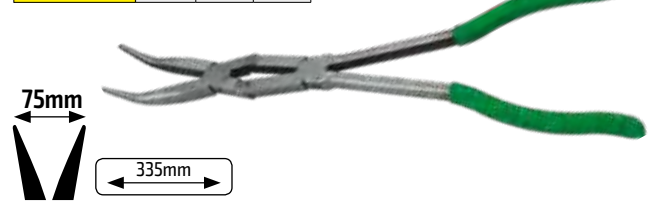

PINZE UNIVERSALI

| | | | | | | |
|--------------|------|---|----|-------|-------|--|
| 52276 | 0,24 | 6 | 60 | 1.920 | 160mm | |
| 8,50€ | | | | | 6" | |

| | | | | | | |
|---------------|------|---|----|-------|-------|--|
| 52277 | 0,31 | 6 | 60 | 1.920 | 180mm | |
| 10,00€ | | | | | 7" | |

| | | | | | | |
|---------------|------|---|----|-------|-------|--|
| 52278 | 0,38 | 6 | 60 | 1.920 | 200mm | |
| 10,50€ | | | | | 8" | |

CrV



TRONCHESI TAGLIO DIAGONALE

| | | | | | | |
|--------------|------|---|----|-------|-------|--|
| 52281 | 0,13 | 6 | 60 | 2.400 | 140mm | |
| 7,50€ | | | | | 5" | |

| | | | | | | |
|--------------|-----|---|----|-------|-------|--|
| 52282 | 0,2 | 6 | 60 | 1.920 | 160mm | |
| 8,00€ | | | | | 6" | |

| | | | | | | |
|--------------|------|---|----|-------|-------|--|
| 52283 | 0,26 | 6 | 60 | 1.920 | 184mm | |
| 9,00€ | | | | | 7" | |

CrV



PINZA PUNTA SPECIALE TERMINALI

| | | | | | | |
|--------------|------|---|----|-------|-------|--|
| 52284 | 0,16 | 6 | 60 | 1.920 | 160mm | |
| 8,50€ | | | | | 6" | |

CrV



PINZA A BECCHI LUNGI

| | | | | | | |
|--------------|------|---|----|-------|-------|--|
| 52279 | 0,15 | 6 | 60 | 1.920 | 160mm | |
| 7,50€ | | | | | 6" | |

| | | | | | | |
|--------------|------|---|----|-------|-------|--|
| 52280 | 0,24 | 6 | 60 | 1.920 | 200mm | |
| 9,00€ | | | | | 8" | |

CrV



PINZA A PAPPAGALLO



| | | | | | |
|---------------|------|---|----|-----|--|
| 52052 | 1,88 | 5 | 10 | 400 | |
| 43,00€ | | | | | |



| | | | | | |
|---------------|------|----|----|-------|--|
| 50567 | 0,34 | 10 | 60 | 1.020 | |
| 11,00€ | | | | | |

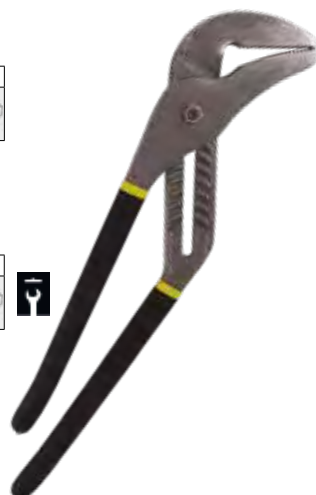

SET DI 6 MINIPINZE DA 120MM

| | | | | | | | | |
|---------------|--|------|--|---|--|----|--|-------|
| 50580 | | 0,47 | | 5 | | 40 | | 1.200 |
| 11,00€ | | | | | | | | |
| | | | | | | | | |
| | | | | | | | | |

Pinza Universale
Pinza Punta
Pinza Taglio
Pinza Spellafili
Pinza Seger
Pinza universale
Piano



SET DI PINZE PER FASCETTE

| | | | |
|---------------|------|----|----|
| 52050 | 3,24 | 4 | 72 |
| 95,00€ | Kg | 11 | 11 |

- Pinze per anello clic-R. Per aprire o chiudere fascette regolabili di tipo clic o clic-R.
- Pinze per il distacco di tubi. Molto utili per il facile distacco di tubi del vuoto e del carburante da 5/32" fino a 1/2".
- Pinze per fascette. Permettono l'estrazione di fascette autoregolabili di plastica e/o metallo da 18 mm a 47mm di diametro.
- Pinze per fascette a ganascia rotante con fessura a "4".
- Pinze per fascette a ganascia rotante.
- Pinze per fascette a nastro piatto. La ganascia ruota di 360° per afferrare da qualsiasi angolo. Per fascette moderne.



RICAMBI DISPONIBILI

| REF. | DESCRIZIONE | Kg | 11 | 11 | € |
|-------|--|------|----|----|--------|
| 13707 | pinze per fascette con punta rotativa | 0,25 | 10 | 40 | 9,00€ |
| 13708 | pinze per fascette elasticas | 0,25 | 10 | 40 | 9,00€ |
| 13709 | pinze per fascette elasticas con punta diritta | 0,24 | 10 | 40 | 9,00€ |
| 13710 | pinze per fascette elasticas 45° | 0,21 | 10 | 40 | 10,00€ |
| 52791 | pinze per fascette "clic-r" e "clic-r" | 0,27 | 10 | 50 | 18,00€ |
| 13712 | pinze per estrazione di tubi | 0,21 | 10 | 40 | 10,50€ |
| 51995 | pinze per fascette | 0,59 | 5 | 40 | 25,00€ |

PINZE PER FASCETTE

| | | | | |
|---------------|------|----|----|-----|
| 51995 | 0,59 | 5 | 40 | 480 |
| 25,00€ | Kg | 11 | 11 | 11 |



| | | | | |
|---------------|------|----|----|-----|
| 53390 | 0,85 | 10 | 20 | 480 |
| 30,00€ | Kg | 11 | 11 | 11 |



PINZE PER FASCETTE PER CONDOTTI DI SCARICO

| | | | |
|---------------|-----|----|----|
| 53396 | 0,5 | 5 | 50 |
| 15,50€ | Kg | 11 | 11 |

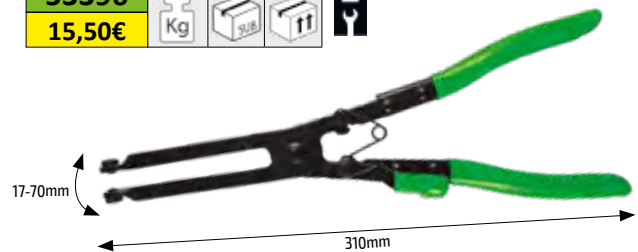

PINZE PER FASCETTE CLIC-R

| | | | | |
|---------------|------|----|----|-------|
| 52791 | 0,27 | 10 | 50 | 1.500 |
| 18,00€ | Kg | 11 | 11 | 11 |

Per il tipo di Click e Click-R.

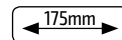

PINZE PER FASCETTE

| | | | | |
|---------------|------|----|----|-----|
| 52619 | 0,56 | 6 | 36 | 648 |
| 25,50€ | Kg | 11 | 11 | 11 |

Fori 1/2" maniglie da utilizzare come chiave.

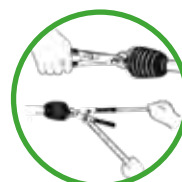

PINZE PER CONDOTTO DEL CARBURANTE

N

| | | | | | |
|---------------|-----|-----|----|-----|--|
| 53487 | 0,3 | 10 | 40 | 720 | |
| 16,00€ | Kg | 3x3 | 11 | | |

Audi / VW, Fiat, GM, Mercedes



PINZE PER FASCETTE

| | | | | | |
|---------------|------|-----|----|-----|--|
| 52812 | 0,87 | 5 | 20 | 500 | |
| 55,00€ | Kg | 3x3 | 11 | | |



Poiché femmina da 3/8 " a cricchetto stringere.



PINZA PER FRENI MOTO

| | | | | | |
|---------------|------|-----|----|-----|--|
| 52389 | 0,32 | 5 | 50 | 600 | |
| 29,00€ | Kg | 3x3 | 11 | | |



Per separare i sistemi frenanti a disco del pistone del freno di motocicli e veicoli.



PINZA APRIFASCETTE

| | | | | | | |
|---------------|------|-----|----|-----|--|--------|
| 52508 | 0,37 | 10 | 50 | 800 | | 0-38mm |
| 36,00€ | Kg | 3x3 | 11 | | | |

| | | | | | | |
|---------------|------|-----|----|-----|--|---------|
| 52509 | 0,39 | 10 | 50 | 800 | | 22-55mm |
| 37,00€ | Kg | 3x3 | 11 | | | |

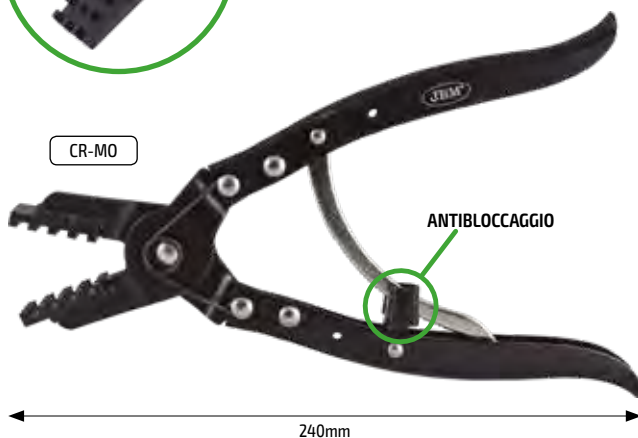

PINZA MOLLA DI RICHIAMO DEL FRENO

| | | | | |
|--------------|------|-----|----|--|
| 52625 | 0,32 | 6 | 48 | |
| 8,00€ | Kg | 3x3 | 11 | |

Per estrarre e installare stazioni di ritorno en frenos tamburo.

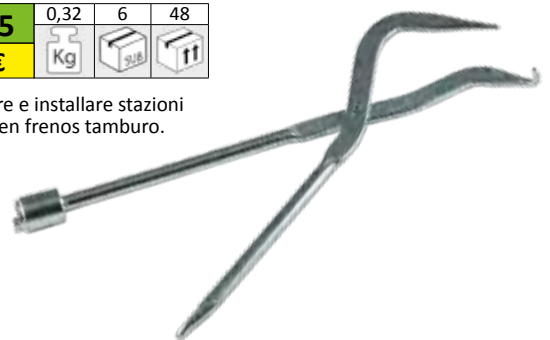

SET DI 2 GANCI PER LEVARE GOMMA DI TUBO DI SCARICO

| | | | | |
|--------------|------|-----|-----|--|
| 52852 | 0,07 | 25 | 100 | |
| 4,50€ | Kg | 3x3 | 11 | |



SET 12 FUSTELLE

METRICI

| | | | | |
|---------------|-----|---|----|-----|
| 52885 | 1,1 | 5 | 20 | 600 |
| 18,00€ | | | | |

3, 4, 5, 6, 7, 8, 9, 10,
12, 14, 16, 19mm



POLLICI

| | | | | |
|---------------|------|----|----|-----|
| 52759 | 1,12 | 10 | 20 | 600 |
| 16,00€ | | | | |

1/8", 5/32", 3/16", 7/32",
1/4", 5/16", 3/8", 7/16", 1/2",
9/16", 5/8", 3/4"



SPAZZOLE METALLICHE

| | |
|--------------|-------|
| 52760 | |
| 5,00€ | |
| | 0,09 |
| | 12 |
| | 120 |
| | 2.160 |



PINZA SPECIALE PER CONTRAPPESI

| | | | | |
|---------------|------|---|----|-----|
| 51355 | 0,45 | 5 | 50 | 500 |
| 16,50€ | | | | |



Toglie facilmente e sostituisce i contrappesi.
Taglia e piega con facilità.
Realizzata in acciaio temperato.
Include manico ergonomico.
Con molle automatico in aperto ne'll
impugnatura per agevolare l'uso.



PINZA FORATRICE ROTATIVA

| | | | |
|--------------|------|---|----|
| 52638 | 0,26 | 5 | 50 |
| 5,50€ | | | |

∅ 2, 2.5, 3, 3.5,
4, 4.5mm



SET 3 SPAZZOLE METALLICHE

| | | | | |
|---------------|------|----|----|-----|
| 52515 | 0,15 | 12 | 72 | 800 |
| 10,50€ | | | | |

225mm

1 x Ottone
1 x Nylon
1 x Acciaio

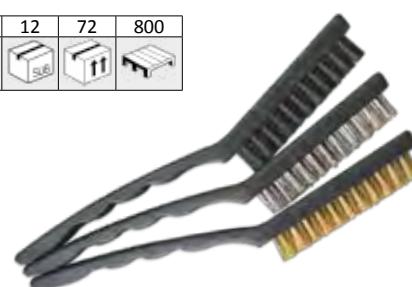

SET DI SPACCADADI

N

| | | |
|---------------|-----|----|
| 53524 | 1,4 | 10 |
| 40,50€ | | |

4
PCS

9-12, 12-16,
16-22, 22-36mm



**RICAMBI
DISPONIBILI** <
SPACCADADI

| REF. | DESCRIZIONE | | | € |
|-------|------------------------|------|----|--------|
| 14049 | 9-12mm (1/8"-1/2") | 0,11 | 50 | 5,50€ |
| 14050 | 12-16mm (1/2"-5/8") | 0,2 | 50 | 7,00€ |
| 14051 | 16-22mm (5/8"-7/8") | 0,44 | 50 | 10,00€ |
| 14052 | 22-36mm (7/8"-1-1/16") | 0,65 | 20 | 12,00€ |

CHIAVI STILLSON

| | | | | | | | |
|------------------------|------------|-----------|-----------|-------------|-----|-------|-------|
| 52235 10,50€ | 0,85 Kg | 10 SUB | 40 ff | 1.140 ff | 12" | 300mm | 50mm |
| 52236 12,00€ | 1,09 Kg | 5 SUB | 20 ff | 760 ff | 14" | 350mm | 55mm |
| 52237 16,00€ | 0,30 Kg | 10 SUB | 40 ff | 720 ff | 18" | 450mm | 60mm |
| 52238 23,50€ | 3,08 Kg | 2 SUB | 8 ff | 600 ff | 24" | 600mm | 75mm |
| 53210 34,00€ | 4,8 Kg | 4 SUB | 128 ff | | 36" | 915mm | 100mm |



CHIAVE IN LEGA DI ALLUMINIO

| | | | | | | | |
|------------------------|------------|----------|----------|-------------|-----|-------|------|
| 53070 15,00€ | 0,68 Kg | 6 SUB | 24 ff | | 12" | 270mm | 45mm |
| 53071 19,50€ | 0,92 Kg | 6 SUB | 24 ff | | 14" | 320mm | 50mm |
| 53072 28,00€ | 1,41 Kg | 6 SUB | 12 ff | | 18" | 410mm | 65mm |
| 53073 42,50€ | 2,12 Kg | 2 SUB | 8 ff | 1.000 ff | 24" | 540mm | 75mm |



CESOIE

| | | | | | | |
|------------------------|------------|----------|-----------|--|-------|-----|
| 52955 17,00€ | 0,77 Kg | 20 ff | 200 ff | | 300mm | 12" |
| 52956 20,00€ | 0,95 Kg | 20 ff | 200 ff | | 350mm | 14" |
| 52957 24,00€ | 1,47 Kg | 12 ff | 204 ff | | 450mm | 18" |
| 52958 31,50€ | 2,41 Kg | 8 ff | 168 ff | | 600mm | 24" |
| 52959 43,00€ | 3,78 Kg | 5 ff | 100 ff | | 750mm | 30" |
| 52960 52,00€ | 4,75 Kg | 4 ff | 96 ff | | 900mm | 36" |



MORSETTO TIPO "FALEGNAME" 11 MISURE

| | | | | | |
|------------------------|------------|----------|-----------|--|------------|
| 52349 14,00€ | 1,25 Kg | 10 ff | 480 ff | | 90x200mm |
| 52350 15,50€ | 1,41 Kg | 10 ff | 540 ff | | 90x300mm |
| 52351 17,00€ | 1,60 Kg | 10 ff | 480 ff | | 90x400mm |
| 52352 20,50€ | 1,99 Kg | 10 ff | 360 ff | | 120x300mm |
| 52353 22,50€ | 2,2 Kg | 10 ff | 350 ff | | 120x400mm |
| 52354 24,00€ | 2,41 Kg | 10 ff | 300 ff | | 120x500mm |
| 52355 26,00€ | 2,62 Kg | 10 ff | 300 ff | | 120x600mm |
| 52356 36,50€ | 4,12 Kg | 5 ff | 250 ff | | 150x600mm |
| 52357 41,00€ | 4,75 Kg | 5 ff | 125 ff | | 150x800mm |
| 52358 45,50€ | 5,35 Kg | 5 ff | 120 ff | | 150x1000mm |
| 52359 50,50€ | 5,96 Kg | 6 ff | 120 ff | | 150x1200mm |





MOBILI DA OFFICINA

| | |
|------------------------------------|----|
| CARRELLI DI STRUMENTI | 58 |
| ORGANIZER | 65 |
| ARMADI | 67 |
| ACCESSORI. | 69 |
| TAVOLO DA LAVORO | 69 |
| VALIGETTA PORTAUTENSILI | 71 |
| BORSA / ZAINI | 72 |
| INCUDINE/ MORSE DA BANCO | 73 |
| SGABELLI | 74 |
| BARELLE | 74 |



| | | | |
|--------------|------|---|---|
| 53514 | 74,5 | 1 | 2 |
| 1.098,00€ | Kg | | |

| | | | |
|--------------|------|---|---|
| 53555 | 74,5 | 1 | 2 |
| 1.098,00€ | Kg | | |

| | | | |
|--------------|------|---|---|
| 53556 | 74,5 | 1 | 2 |
| 1.098,00€ | Kg | | |

| | | | |
|--------------|------|---|---|
| 53557 | 74,5 | 1 | 2 |
| 1.098,00€ | Kg | | |

Ruote non montate.



Modulo1:

ESTRATTORI FILTRO OLIO



22
PCS

- 20x strattore per filtro olio
- 1x cricchetto da 1/2"
- 1x chiave esagonale

*Ricambi disponibili p.130

Modulo2:

RIPOSIZIONATORE DAL PISTONE DAL FRENO

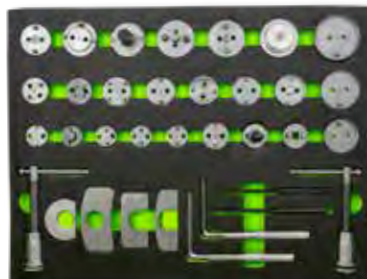

34
PCS

- 24x adattatori
- 4x piastre di ritenzione
- 2x assi per filettatura

- 2x punzoni
- 2x chiavi esadacimali

*Ricambi disponibili p.128

Modulo3:

RIPARAZIONE DI TAPPI CARTER E FILTRI OLIO REGOLABILI

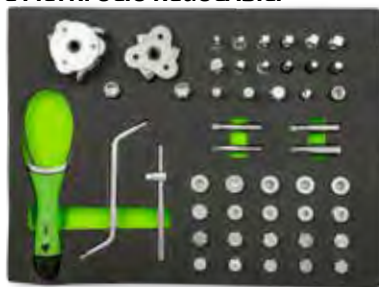

- 1x chiave di Carter 8 x 10mm
- 1x estrattore filtro olio con piede piano 57-125mm
- 1x estrattore filtro olio con piede rotondo 69-135mm
- 1x estrattore filtro regolabile 65-105mm 110-155mm
- 9x vaso quadrato 1x vaso quadrato femminile
- 1x vaso triangolare 6x vaso esagonale
- 1x manico scorrevole + scorrevole 165mm
- 4x scalpello 20x tappo 40x rondelle

86
PCS

Modulo4:

FUCILE E VASO DI IMPATTO



6
PCS

- 3x vaso impatto da 1/2" speciale estrazione ruote 17-21mm
- 1x chiave a croce unione saldata
- 1x fucile da impatto nano 1/2" 1356Nm
- 1x lampada portatile

Modulo5:

108 PEZZI CON VASI ESAGONALI



108
PCS

- 1x cricchetto universale da 72 denti da 1/2" con espulsore da vaso
- 1x adattatore di testine 1/2" x 5/16"
- 5x vasi metrici lunghi da 1/2"
- 17x vasi metrici da 1/2"
- 8x vasi torx da 1/2"
- 2x vasi di candele da 1/2"
- 2x barre di estensione da 5" e 10"
- 1x articolazione universale da 1/2"
- 1x adattatore 3/8" femminile - 1/2" maschi
- 1x cricchetto universale da 72 denti da 1/4" con espulsore di vasi

- 18x testine per cacciavite di punta (PH/PZ/HEX/SL/TX)
- 1x manico cacciavite da 1/4"
- 1x articolazione universale da 1/4"
- 1x manico scorrevole da 1/4"
- 2x barre di estensione da 2" e 3"
- 13x vasi metrici
- 8x vasi lunghi da 1/4"
- 5x vasi torx da 1/4"
- 17x testine (8 mm: HEX/SL/PH/PZ/TX)
- 3x chiavi allen

CARRELLO A 7 CASSETTI CON GUIDA TELESCOPICA



180
PCS

| | | | | |
|----------------|------|---|---|--------|
| 52705 | 80 | 1 | 2 | ARMADO |
| 768,00€ | Kg | | | |
| 52707 | 59,7 | 1 | 2 | VUOTO |
| 572,00€ | Kg | | | |

| | | | | |
|----------------|------|---|---|--------|
| 52825 | 79 | 1 | 2 | ARMADO |
| 768,00€ | Kg | | | |
| 52709 | 59,7 | 1 | 2 | VUOTO |
| 572,00€ | Kg | | | |

| | | | | |
|----------------|----|---|---|--------|
| 52706 | 80 | 1 | 2 | ARMADO |
| 768,00€ | Kg | | | |
| 52708 | 58 | 1 | 2 | VUOTO |
| 572,00€ | Kg | | | |

| | | | | |
|----------------|----|---|---|--------|
| 53534 | 79 | 1 | 2 | ARMADO |
| 768,00€ | Kg | | | |
| 53535 | 58 | 1 | 2 | VUOTO |
| 572,00€ | Kg | | | |

N



MISURE INTERNE

| | | |
|------|-------|-------|
| 60mm | 535mm | 400mm |
|------|-------|-------|

CASSETTI PICCOLI (x5)

| | | |
|-------|-------|-------|
| 130mm | 535mm | 400mm |
|-------|-------|-------|

CASSETTI MEDI (x1)

| | | |
|-------|-------|-------|
| 200mm | 535mm | 400mm |
|-------|-------|-------|

CON ATTREZZATURE EVA:

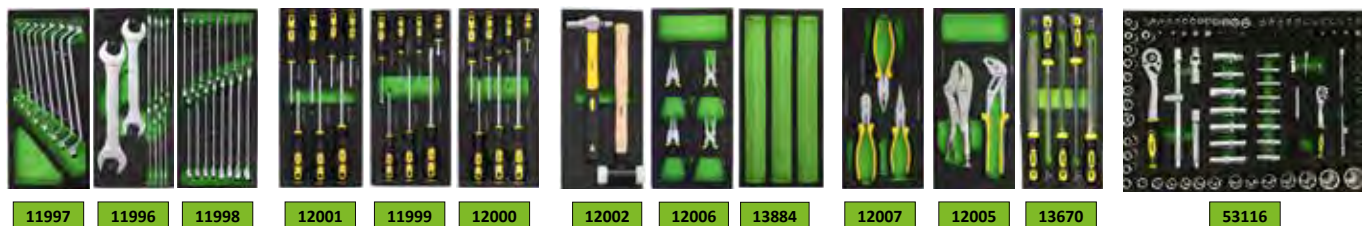

+INFO ATTREZZATURE P.65

CASSETTIERA MOBILE GRIGIA CON SISTEMA ANTIRIBALTAMENTO - XL

192
PCS

N

| | | | |
|------------------|------|---|---|
| 53435 | 81,5 | 1 | 2 |
| 1.083,50€ | Kg | | |

| | | | |
|------------------|------|---|---|
| 53436 | 81,5 | 1 | 2 |
| 1.083,50€ | Kg | | |



ANTI-RIBALTAMENTO!

XL

930mm



53116

13922

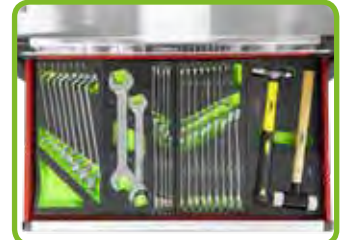

11997

11996

11998

12002

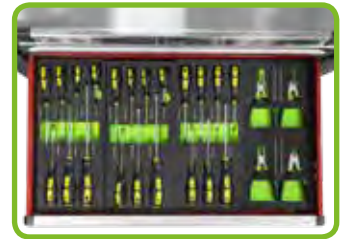

12001

11999

12000

12006



12007

12005

13670

13884

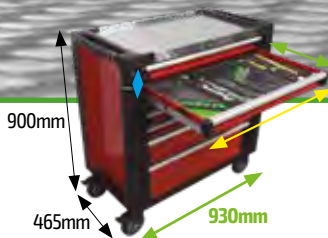

MISURE INTERNE
CASSETTI PICCOLI (x5)

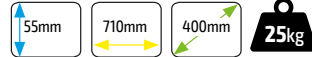

CASSETTO MEDIO (x1)

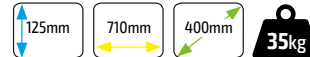

CASSETTO GRANDE (x1)

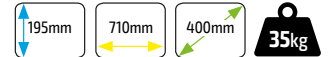

IMPUGNATURA
ERGONOMICA,
MORBIDA E
ANTISCIVOLO

50kg

VASSOIO IN ACCIAIO
INOSSIDABILE PIÙ
RESISTENTE

BLOCCO DI SICUREZZA
CON CHIAVE.

CARRELLO IN ACCIAIO
SALDATO DI ALTA QUALITÀ
E VERNICIATO CON VERNICE
EPOSSIDICA PER DARE
RESISTENZA E PREVENIRE
LA CORROSIONE E
L'OSSIDAZIONE.

RUOTE DA 125 MM DI DIAMETRO CHE CONSENTONO DI
LIVELLARE LA SUPERFICIE IRREGOLARE DAL TERRENO E
FORNIRE UN'ELEVATA CAPACITÀ DI CARICO. CON FUNZIONE
DI FRENO E STERZO.

CASSETTI CON GUIDA TELESCOPICA CON
CUSCINETTI SU ENTRAMBI I LATI DEI CASSETTI PER
AMMORBIDIRE, SILENZIARE E DARE STABILITÀ.
ESTENSIONE COMPLETA PER IL 100% APERTA.

CASSETTI CON SISTEMA AUTOBLOCCANTE: CONSENTE IL
RITORNO AUTOMATICO SENZA OPERAZIONI PRECEDENTI.
MANIGLIA DEL CASSETTO IN ALLUMINIO, EXTRA LARGA PER
UNA FACILE APERTURA / SERRATURA.

CARRELLO MOBILE ANTIRIBALTAMENTO ARMADO EVA

180
PCS

N

| | | | | |
|----------------|----|---|---|--------|
| 53035 | 71 | 1 | 2 | ARMADO |
| 945,00€ | Kg | | | |

| | | | | |
|----------------|----|---|---|--------|
| 53036 | 71 | 1 | 2 | ARMADO |
| 945,00€ | Kg | | | |

| | | | | |
|----------------|----|---|---|--------|
| 53113 | 71 | 1 | 2 | ARMADO |
| 945,00€ | Kg | | | |

| | | | | |
|----------------|----|---|---|-------|
| 53461 | 53 | 1 | 2 | VUOTO |
| 627,00€ | Kg | | | |

| | | | | |
|----------------|----|---|---|-------|
| 53462 | 53 | 1 | 2 | VUOTO |
| 627,00€ | Kg | | | |

| | | | | |
|----------------|----|---|---|-------|
| 53034 | 53 | 1 | 2 | VUOTO |
| 627,00€ | Kg | | | |

| | | | | |
|----------------|------|---|---|--------|
| 53446 | 70,5 | 1 | 2 | ARMADO |
| 945,00€ | Kg | | | |

Blocco di sicurezza con chiave.
Angoli protetti con gomma molto resistente.
Ruote non montate.



ANTIRIBALTAMENTO!



SUPERFICIE ANTI-SCIVOLO

LATO SUPPORTO DEL VASSOIO PER SPRAY

CASSETTI CON TASTO

RUOTA CON SISTEMA FRENANTE



CASSETTI PICCOLI (x5)

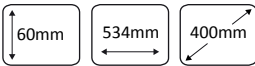

CASSETTO MEDIO (x1)

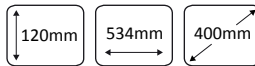

CASSETTO GRANDE (x1)

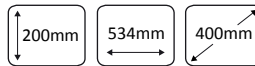

CON ATTREZZATURE EVA:



11997 11996 11998 12001 11999 12000 12002 12006 13884 12007 12005 13670 53116

+INFO ATTREZZATURE P.65

CARRELLO MOBILE 6 CASSETTI

171
PCS

Ruote non montate

| | | | | |
|----------------|----|---|---|--------|
| 53195 | 41 | 1 | 2 | ARMADO |
| 548,00€ | Kg | | | |

| | | | | | |
|----------------|----|---|---|-------|----------|
| 53194 | 41 | 1 | 2 | VUOTO | N |
| 379,50€ | Kg | | | | |



CASSETTI GRANDI (x2)

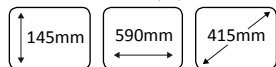

CASSETTI PICCOLI (x4)

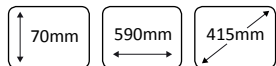

RUOTA CON SISTEMA FRENANTE



CASSETTI CON GUIDA TELESCOPICA



BLOCCO DI SICUREZZA CON CHIAVE

53195



53117



10679 10726 10680



10676 10677 10678



10728 10729 10730

+INFO ATTREZZATURE P.65

CARRELLO CON DOPPIA COLONNA DI 12 CASSETTI



171
PCS

| | | | | |
|----------------|--------|---|--|-------|
| 51427 | 108,00 | 1 | | VUOTO |
| 988,00€ | Kg | | | |

| | | | | |
|------------------|--------|---|--|--------|
| 53546 | 129,00 | 1 | | ARMADO |
| 1.265,00€ | Kg | | | |



MISURE INTERNE 1a COLONNA

| | | | |
|-----------------------|-------|-------|-------|
| A | 55mm | 530mm | 395mm |
| CASSETTI PICCOLI (x3) | | | |
| B | 125mm | 530mm | 395mm |
| CASSETTI MEDI (x2) | | | |
| C | 195mm | 530mm | 395mm |
| CASSETTI GROSSI (x1) | | | |

MISURE INTERNE 2a COLONNA

| | | | |
|-----------------------|-------|-------|-------|
| D | 55mm | 265mm | 395mm |
| CASSETTI PICCOLI (x3) | | | |
| E | 125mm | 265mm | 395mm |
| CASSETTI MEDI (x2) | | | |
| F | 195mm | 265mm | 395mm |
| CASSETTI GROSSI (x1) | | | |

CHIUSURA CON CIGLIA

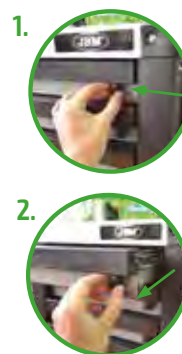

53546



53116



12007

12002

12005

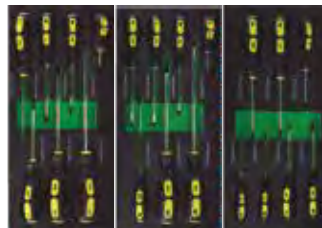

51378

51380

51381



11997

11996

11998

FINITURA CROMATA

+INFO ATTREZZATURE P.65

IVA esclusa

JBM

WWW.JBMCAMP.COM

JBM
2019

63

ARMADI

CARRELLO 7 CASSETTI CON GUIDA TELESCOPICA CON E SENZA ATTREZZATURA

179
PCS

VUOTO

| | | | |
|----------------|----|---|---|
| 52172 | 58 | 1 | 2 |
| 416,00€ | Kg | | |

Ruote non montate.

ARMADO

| | | | |
|----------------|------|---|---|
| 52393 | 69,5 | 1 | 2 |
| 792,00€ | Kg | | |



RIVESTITO IN GOMMA ANTISCIVOLO



CHIUSURA



RUOTE CON FRENO



MISURE INTERNE

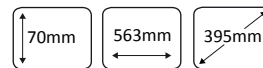

CASSETTI PICCOLI (x5)

MISURE INTERNE

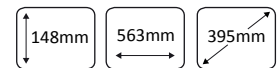

CASSETTI GRANDI (x2)

52393



10728 10729 10730



10680 10727 11118



10676 10677 10678



10679 10726 10735



53117

+INFO ATTREZZATURE P.65

CARRELLO CON 1 RIPIANO CON GUIDA TELESCOPICA

| | | | |
|----------------|----|---|---|
| 52826 | 33 | 1 | 2 |
| 319,00€ | Kg | | |



VASSOIO SEPARATORE



SUPERFICIE DI GOMMA



ANGOLI CON PROTEZIONE

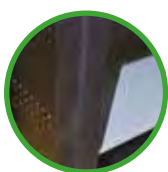

CHIUSURA LINGUETTA

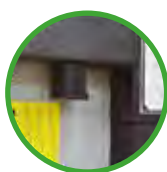

MISURE INTERNE CASSETTO

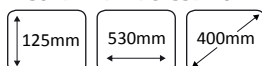

ATTREZZATURE 175x30x380mm



10676 0,77 10 220
12,00€

3.0x75, 3.5x75, 4.0x100,
5x100, 6x150, 8.0x175,
6x38mm



10677 0,94 10 220
13,00€

0x75, 1x100, 2x38,
2x100, 2x125,
3x150, 4x200mm



10678 0,89 10 220
11,50€

10x75, 15x75, 20x100,
25x100, 27x100,
30x125, 40x150mm



10679 1,21 10 220
20,50€

8", 8", 7.5"



10680 1,55 10 300
23,50€



10726 1,25 10 220
18,50€



10727 0,4 10 220
20,50€

1.7, 2.4, 2.5, 3cm



10728 1,18 10 220
28,00€

6x7, 8x9, 10x11, 12x13,
14x15, 16x17, 18x19,
20x22mm



10729 2,07 10 220
42,00€

6, 7, 8, 9, 10, 11, 12, 13, 14, 15,
16, 17, 18, 19, 20, 21, 22mm



10730 2,15 6 220
36,00€

6x7, 8x9, 10x11, 12x13, 14x15,
16x17, 18x19, 20x22, 24x27,
30x32mm



10731 0,92 10 220
15,00€



10732 0,7 10 220
19,00€



10733 0,69 10 220
15,50€



10735 0,92 5 10 220
18,00€



10736 0,18 10 240
6,50€

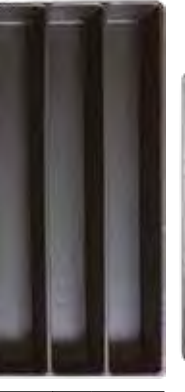

11118 0,01 10 300
4,50€



535x50x400mm
13944 0 12 192
21,50€



525x30x380mm
53117 6,45 3 84
103,00€

ATTREZZATURE EVA 175x30x380mm



13667 0,83 10 360
16,50€



13668 0,61 10 300
17,50€



13669 0,61 10 360
16,50€



13922 1,5 12 240
63,00€

8,9,10,11,12,13,14,15,16,
17,18,19mm



11993 3,38 10 230
78,50€

1/2"



11994 - 10 233
34,00€

1/4"



11995 2,7 10 150
56,50€

8, 10, 11, 12, 13, 14, 15,
16, 17, 18, 19



11996 2,06 10 200
46,00€ Kg ft
 6x7mm - 20x22mm +
 24x27mm + 30x32mm



11997 1,22 10 300
36,50€ Kg ft
 6x7mm - 18x19mm +
 20x22mm



11998 1,87 10 200
51,00€ Kg ft
 6x7mm - 18x19mm +
 20x22mm



12002 1,37 10 240
27,00€ Kg ft



12003 1,64 10 240
43,50€ Kg ft
 6, 12, 16, 19mm /
 10, 8, 6mm / 8, 10mm



12007 1,14 10 300
24,00€ Kg ft
 8", 8", 7.5"



13670 1 10 300
20,00€ Kg ft



13884 0,1 10 300
9,00€ Kg ft



13923 0,05 30
7,50€ Kg ft



51380 0,8 10 30 240
18,00€ Kg ft



51378 0,81 10 30 240
18,00€ Kg ft



51381 0,55 10 30 240
13,50€ Kg ft



12004 0,7 10 200
21,50€ Kg ft
 6x150, 5x150, 3x100, 2x100,
 2.5x100, 4x50mm



12005 1,16 10 300
22,50€ Kg ft
 2, 2.4, 2.8, 3cm



12006 0,73 10 300
23,50€ Kg ft



53116 6,25 3 72
109,50€ Kg ft
 525x30x380mm

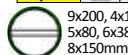

9x200, 4x125, 5x100,
 5x80, 6x38, 6x100,
 8x150mm

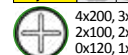

4x200, 3x150,
 2x100, 2x38, 1x80,
 0x120, 1x100mm

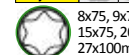

8x75, 9x75, 10x75,
 15x75, 20x75, 25x100,
 27x100mm

ACCESSORI (NON COMPRESI) PER REF.

REF. 52705, 52825, 52704, 52764, 52826, 53035, 53036, 53113, 53461, 53462, 53034



TASCA PORTADOCUMENTI

51431 2,11 5 4
14,00€ Kg ft



SECCHIO PER L'IMMONDIZIA APPENDIBILE

51432 2 5 30
44,50€ Kg ft



VASSOIO LATERALE PER SPRAY

12985 0,35 1 5
11,50€ Kg ft



ARMADIO AUSILIARE LATERALE

51435 4,83 2
100,00€ Kg ft

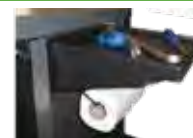

APPENDI-ROTOLO DI CARTA E VASSOIO

51436 1,19 5
37,00€ Kg ft



PARETE PORTA UTENSILI PER CASSETTIERA

51430 0,55 2
120,00€ Kg ft

PER SERIE ANTIRIBALTAMENTO:



PORTA SPRAYS
13940 0,45 1 6
16,00€ Kg ft



PORTA DOCUMENTI
13941 0,8 1 6
20,50€ Kg ft



PORTA ROTOLI
13942 1,5 1 6
34,00€ Kg ft



BIDONE
13943 1,9 1 2
32,50€ Kg ft

CARRELLO 9 CASSETTI CON SEPARATORI E GUIDE TELESCOPICHE

| | | | |
|----------------|------|---|---|
| 52360 | 72,5 | 1 | 4 |
| 539,00€ | Kg | | |

Ruote non montate.



ARMADIO



CASSETTI

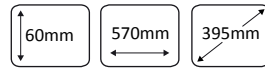

MISURE SEPARATORI



50 x 56mm

11205 2,00€



96 x 56mm

11206 2,00€



142 x 56mm

11207 3,00€



189 x 56mm

11208 3,50€



235 x 56mm

11209 5,50€



280 x 56mm

11210 5,50€



396 x 56mm

11211 8,00€



SET 4 RUOTE PER CARRELLO REF. 51456

Ø12cm

2 Ruote con freni + 2 semplici

| | | |
|---------------|------|---|
| 11313 | 4,11 | 1 |
| 46,50€ | Kg | |



ARMADIO DI LAVORO MULTIMEDIA CON RUOTE

| | | | |
|----------------|------|---|---|
| 51456 | 42,5 | 1 | 2 |
| 544,50€ | Kg | | |

Ruote non montate.

ESTERNO

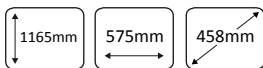

CASSETTO SUPERIORE

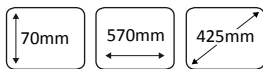

ARMADIO INFERIORE

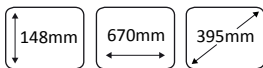

SPAZIO FRA VASSOI



SET 4 RUOTE PER CARRELLO
REF. 51456

Ø12cm

2 Ruote con freni + 2 semplici

| | | |
|---------------|------|---|
| 11313 | 4,11 | 1 |
| 46,50€ | Kg | |



CARRELLO CON 3 RIPIANI

51576

15 1 22

97,00€

Kg

1

22

100Kg

Ruote non montate.



CARRELLO CON 3 RIPIANI MAXI

52373

24,7 1 10

148,50€

Kg

1

10

150Kg

Ruote non montate.



CARRELLO CON 4 E 6 CASSETTI



4 CASSETTI

51426

36 1 4

434,50€

Kg

1

4

550mm

680mm

460mm

CHIUSURA
CON CIGLIA



51426



51425

6 CASSETTI

51425

39,5 1 3

549,00€

Kg

1

3

700mm

680mm

460mm

550mm

TAVOLO DI LAVORO CON PANNELLO FRONTALE

| | | | |
|----------------|------|---|---|
| 51035 | 86,5 | 1 | 5 |
| 583,00€ | Kg | | |

| | | |
|---------|---------|-------|
| 1.550mm | 1.500mm | 640mm |
|---------|---------|-------|



PANNELLO APPENDI ATTREZZI

| | | | | |
|---------------|------|---|----|---------------|
| 52419 | 7,49 | 1 | 37 | 1.000 x 600mm |
| 79,50€ | Kg | | | |

| | | | | |
|----------------|-------|---|----|---------------|
| 52420 | 10,80 | 1 | 35 | 1.500 x 600mm |
| 120,00€ | Kg | | | |

| | | | | |
|----------------|----|---|----|---------------|
| 52421 | 14 | 1 | 38 | 2.000 x 600mm |
| 133,50€ | Kg | | | |



GANCIO SPECIALE CHIAVI

| | | | |
|--------------|------|---|----|
| 51653 | 0,28 | 5 | 10 |
| 8,00€ | Kg | | |

Per ref.:
51035, 52419, 52420, 52421



GANCIO SPECIALE GIRAVITI

| | | | | |
|--------------|-----|----|-------|----------------------------|
| 51657 | 0,3 | 50 | 1.000 | Per ref.: |
| 9,00€ | Kg | | | 51035, 52419, 52420, 52421 |



GANCIO PER REF. 51035 E PER PENNELLI DI ATTREZZATURE REF. 52419, 52420, 52421

| | | | |
|-----------------------------|------|----|-----|
| GANCIO DOPPIO CHIUSO | 95mm | | |
| 51654 | 0,09 | 10 | 100 |
| 4,00€ | Kg | | |

| | | | |
|----------------------------|------|----|-----|
| GANCIO DOPPIO LUNGO | 92mm | | |
| 51658 | 0,05 | 10 | 100 |
| 4,00€ | Kg | | |

| | | | |
|----------------------------|------|----|-----|
| GANCIO DOPPIO CORTO | 31mm | | |
| 51655 | 0,07 | 10 | 100 |
| 4,50€ | Kg | | |

| | | | |
|----------------------------------|-------|----|-----|
| GANCIO DOPPIO EXTRA LUNGO | 200mm | | |
| 52634 | 0,14 | 10 | 100 |
| 4,50€ | Kg | | |

| | | | |
|------------------------|------|----|-----|
| GANCIO SEMPLICE | 91mm | | |
| 51656 | 0,07 | 10 | 100 |
| 4,50€ | Kg | | |

| | | | |
|---|-------|----|-----|
| GANCIO DOPPIO EXTRA LUNGO CHIUSO | 200mm | | |
| 52635 | 0,14 | 10 | 100 |
| 4,00€ | Kg | | |

GANCIO PER TAVOLO REF. 51428

| | | | |
|---------------------|------|-----|--|
| GANCIO CORTO | 51mm | | |
| 51418 | 0,03 | 100 | |
| 3,00€ | Kg | | |

| | | | |
|----------------------------|------|-----|--|
| GANCIO DOPPIO CORTO | 55mm | | |
| 51421 | 0,02 | 100 | |
| 4,00€ | Kg | | |

| | | | |
|---------------------|------|-----|--|
| GANCIO LUNGO | 90mm | | |
| 51419 | 0,03 | 100 | |
| 3,50€ | Kg | | |

| | | | |
|----------------------------|------|-----|--|
| GANCIO DOPPIO LUNGO | 95mm | | |
| 51422 | 0,05 | 100 | |
| 4,00€ | Kg | | |

| | | | |
|---------------------------|------|-----|--|
| GANCIO CORTO FONDO | 50mm | | |
| 51420 | 0,03 | 100 | |
| 3,50€ | Kg | | |

| | | | |
|----------------------|------|-----|--|
| GANCIO CHIUSO | 95mm | | |
| 51423 | 0,04 | 100 | |
| 4,50€ | Kg | | |

GANCIO DA PARETE PER REF. 51430 (NON COMPRESI)

| | | | |
|------------------------------|------|-----|--|
| GANCIO SEMPLICE CORTO | 40mm | | |
| 51974 | 0,02 | 100 | |
| 2,00€ | Kg | | |

| | | | |
|----------------------------|------|-----|--|
| GANCIO DOPPIO LUNGO | 75mm | | |
| 51976 | 0,03 | 100 | |
| 2,50€ | Kg | | |

| | | | |
|------------------------------|------|-----|--|
| GANCIO SEMPLICE FONDO | 30mm | | |
| 51975 | 0,03 | 100 | |
| 2,00€ | Kg | | |

| | | | |
|----------------------------|------|-----|--|
| GANCIO LUNGO CHIUSO | 75mm | | |
| 51977 | 0,02 | 100 | |
| 3,00€ | Kg | | |

TAVOLO DI LAVORO A 3 CASSETTI

51738

| | | |
|------|---|---|
| 81,5 | 1 | 5 |
|------|---|---|

544,50€



Cassetto:

- Capacità massima: 50kg
- Misure: 348 x 441 x 142mm

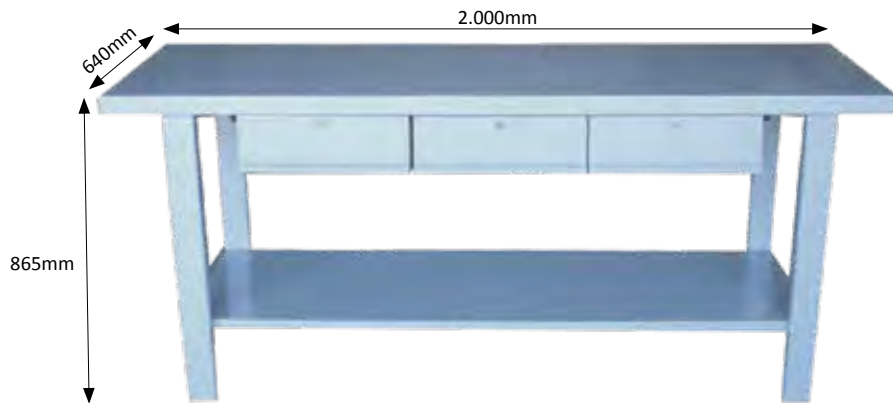

865mm

TAVOLO DI LAVORO A 2 CASSETTI

51737

| | | |
|------|---|---|
| 65,5 | 1 | 5 |
|------|---|---|

469,00€

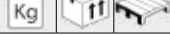

Cassetto:

- Capacità massima: 50kg
- Misure: 348 x 441 x 142mm

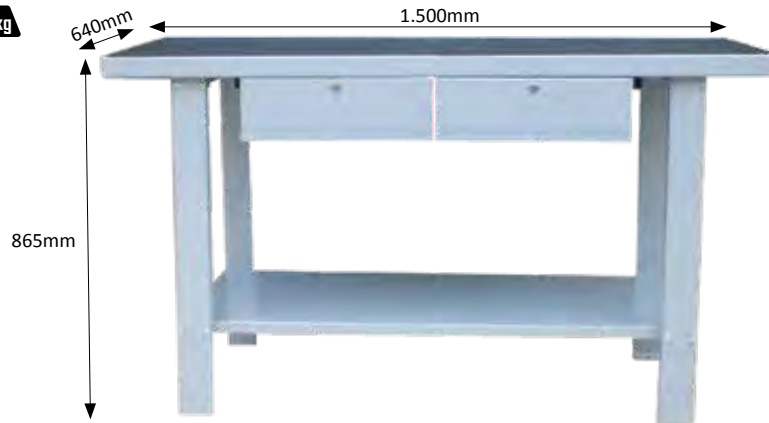

865mm

TAVOLO DI LAVORO

53193

| | |
|------|---|
| 44,7 | 1 |
|------|---|

329,00€



Capacità massima del cassetto: 25kg.

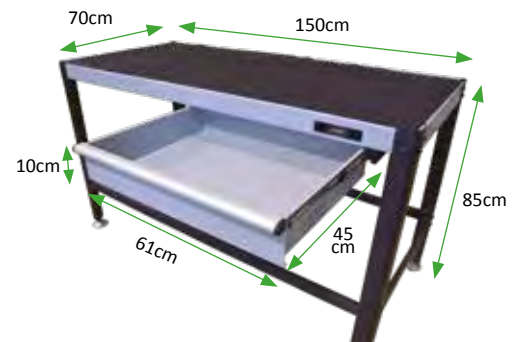
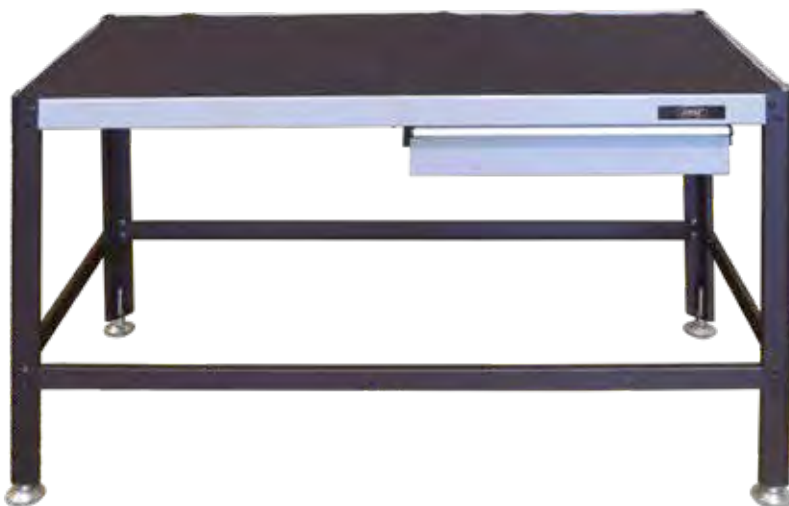

TAVOLO DI LAVORO CON 4 CASSETTI INFERIORI CON PERSIANA PIEGHEVOLE

| | | | |
|------------------|-----|---|---|
| 51428 | 138 | 1 | 2 |
| 1.089,00€ | | | |

| | | |
|---------|---------|-------|
| 1.460mm | 1.500mm | 750mm |
|---------|---------|-------|



CASSETTA PER UTENSILI PIEGHEVOLE CON 6 SCOMPARTI

| | | | |
|---------------|-----|--|--|
| 51574 | | | |
| 32,00€ | | | |
| | 4,3 | | |
| | 4 | | |
| | 35 | | |

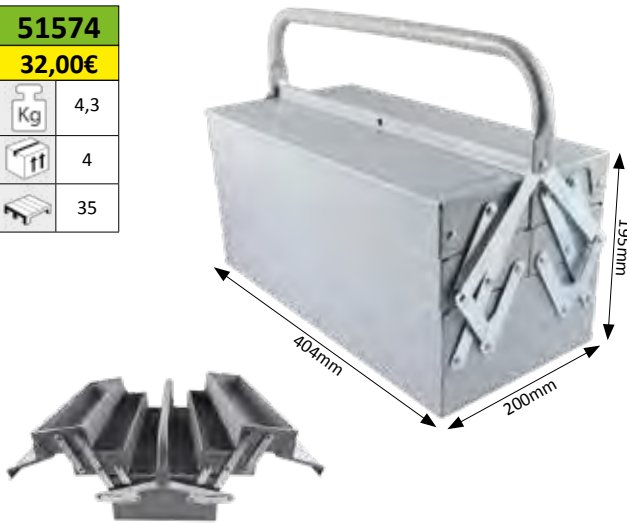

CASSETTA PER UTENSILI PIEGHEVOLE 75cm

| | | | |
|---------------|------|---|----|
| 53222 | 6,25 | 1 | 25 |
| 43,00€ | | | |



CASSETTA PER UTENSILI CON TRE CASSETTI FRONTALI

| | | | |
|---------------|------|---|----|
| 51600 | 7,69 | 1 | 18 |
| 73,00€ | | | |



CASSETTA PER UTENSILI CON 4 CASSETTI

| | | | |
|----------------|-------|---|---|
| 51575 | 19,75 | 1 | 9 |
| 202,50€ | | | |

Cassetti grossi: 570mm larghezza
Cassetti piccoli: 180mm larghezza

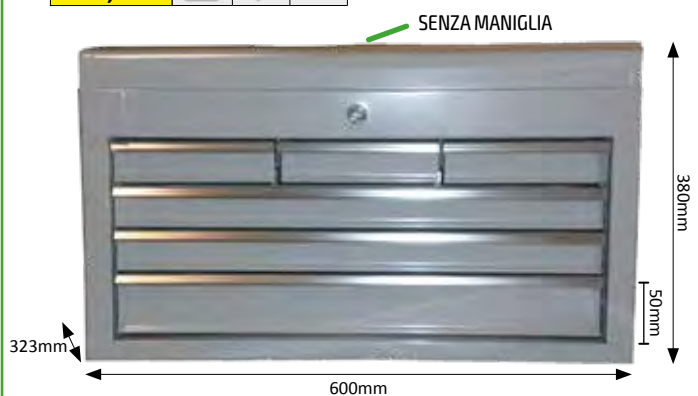

ZAINO PER ATTREZZI

| | | | |
|---------------|-----|---|----|
| 53258 | 2,6 | 2 | 32 |
| 83,00€ | Kg | | |

Non include strumenti.



BORSA PER ATTREZZI

| | | | |
|----------------|-----|---|----|
| 53253 | 4,5 | 2 | 12 |
| 131,50€ | Kg | | |

600D Polyester.
Non include strumenti.



BORSA PER ATTREZZI

| | | | |
|---------------|-----|---|----|
| 53252 | 1,8 | 4 | 16 |
| 47,00€ | Kg | | |

600D polyester.
Non include strumenti.

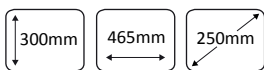

CON MANICO RICOPERTO
DI SCHIUMA PER UN
COMODO TRASPORTO

MORSA DA OFFICINA 150MM VELOCE

| | | | | | | |
|----------------|------|---|----|----|-------|-------|
| 52871 | 24,5 | 1 | 28 | 6" | 150mm | 254mm |
| 219,00€ | Kg | | | | | |



APERTURA IMMEDIATA CON LEVA + BANCO GIREVOLE

MORSA DA BANCO GIREVOLE

| | | | | | | |
|---------------|------|---|-----|----|-------|------|
| 53031 | 5,78 | 1 | 162 | 4" | 100mm | 75mm |
| 50,50€ | Kg | | | | | |

| | | | | | | |
|----------------|-------|---|----|----|-------|-------|
| 53032 | 13,71 | 1 | 60 | 6" | 150mm | 125mm |
| 109,00€ | Kg | | | | | |



MORSA DA OFFICINA

| | | | | | | |
|----------------|-------|---|----|----|-------|-------|
| 51570 | 15,02 | 1 | 48 | 4" | 100mm | 100mm |
| 148,50€ | Kg | | | | | |

| | | | | | | |
|----------------|-------|---|----|----|-------|-------|
| 51572 | 28,95 | 1 | 28 | 6" | 150mm | 150mm |
| 306,00€ | Kg | | | | | |



MORSA DA OFFICINA

| | | | | | | |
|---------------|------|---|-----|----|-------|------|
| 52869 | 4,96 | 4 | 168 | 4" | 100mm | 75mm |
| 47,50€ | Kg | | | | | |

| | | | | | | |
|----------------|-------|---|----|----|-------|-------|
| 52870 | 12,12 | 1 | 72 | 6" | 150mm | 125mm |
| 100,50€ | Kg | | | | | |



INCUDINE PROFESSIONALE

FERRO

| | | | | | | |
|---------------|-------|---|-----|-------|-------|------|
| 52306 | 10,17 | 1 | 100 | 143mm | 285mm | 85mm |
| 55,00€ | Kg | | | | | |

| | | | | | | |
|----------------|----|---|----|-------|-------|-------|
| 52307 | 25 | 1 | 50 | 165mm | 365mm | 103mm |
| 130,00€ | Kg | | | | | |



ACCIAIO

| | | | | | | |
|----------------|----|---|----|-------|-------|-------|
| 52308 | 50 | 1 | 20 | 190mm | 625mm | 140mm |
| 406,00€ | Kg | | | | | |

| | | | | | | |
|----------------|-----|---|---|-------|-------|-------|
| 52309 | 100 | 1 | 9 | 245mm | 790mm | 180mm |
| 806,50€ | Kg | | | | | |



SGABELLO REGOLABILE PNEUMATICO

| | | | |
|---------------|------|---|----|
| 50843 | 5,61 | 1 | 42 |
| 59,50€ | Kg | | |

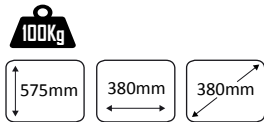

Min: 420mm
Max: 540mm



SGABELLO IN ACCIAIO

| | | | |
|---------------|-----|---|----|
| 50844 | 3,5 | 1 | 52 |
| 46,50€ | Kg | | |



CARRELLO DI PLASTICA

| | | | |
|---------------|------|---|----|
| 52148 | 4,72 | 1 | 19 |
| 59,50€ | Kg | | |



Plastica di alta densità.
Ruote rinforzate di gomma.
Molto resistente.

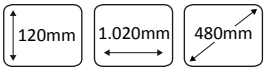

CARRELLO PIEGHEVOLE METALLICO

| | | | |
|---------------|------|---|----|
| 50808 | 5,63 | 1 | 24 |
| 53,00€ | Kg | | |

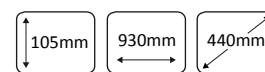

CARRELLO IN METALLO E PLASTICA

| | | | |
|---------------|-----|---|----|
| 53211 | 5,4 | 1 | 36 |
| 59,50€ | Kg | | |

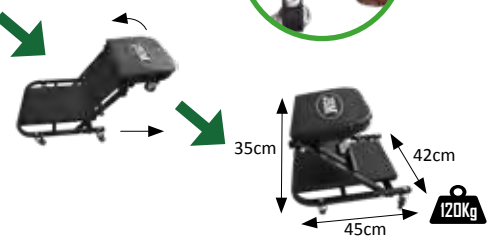
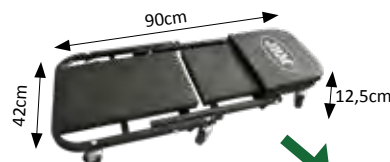

| | | | |
|----------------|------|---|----|
| 52542 | 12,7 | 1 | 17 |
| 109,00€ | Kg | | |

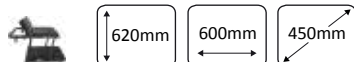

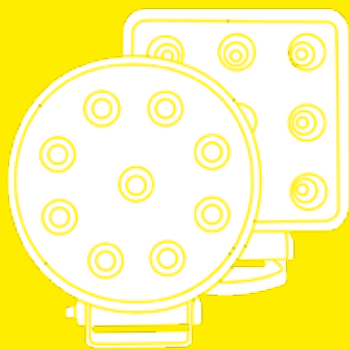

ILLUMINAZIONE

| | |
|----------------------------------|----|
| LAMPADA PORTATILE | 75 |
| LENTE DI INGRANDIMENTO | 79 |
| TORCIA TASCABILE | 80 |
| FARO PORTATILE | 81 |
| FLUORESCENTE DA COFANO | 81 |
| LAMPADA D'ISPEZIONE | 82 |
| ALLINEATORE DI FARI | 82 |
| LUCE ROTANTE | 83 |
| AVVISATORE ACUSTICO | 85 |
| LAMPADA DA LAVORO | 86 |
| BARRA PER RIMORCHIO | 89 |
| LAMPADE PER AUTO | 90 |



TORCIA PORTATILE A LED CON BASE MAGNETICA REGOLABILE

N

| | | | |
|---------------|-----|----|----|
| 53465 | 0,4 | 12 | 24 |
| 38,50€ | Kg | | |

| | | | | | |
|---------------|-------------|-------------------|--------------------|------------------|-------------------|
| 300 Lm | 3-4H | LED 3W COB | LED 2.5H 3W | LED 7H 3W | 3.7V 2.0Ah |
|---------------|-------------|-------------------|--------------------|------------------|-------------------|

| | | | |
|---------------|-----|----|----|
| 53466 | 0,4 | 12 | 24 |
| 43,00€ | Kg | | |

| | | | | | |
|---------------|-------------|-------------------|------------------|-------------------|-------------------|
| 500 Lm | 6-7H | LED 3W COB | LED 3H 3W | LED 14H 3W | 3.7V 4.0Ah |
|---------------|-------------|-------------------|------------------|-------------------|-------------------|

| | | | |
|---------------|-----|----|----|
| 53467 | 0,4 | 12 | 24 |
| 51,00€ | Kg | | |

| | | | | |
|----------------|-------------|--------------------|------------------|-------------------|
| 1000 Lm | 6-8H | LED 10W COB | LED 3H 3W | LED 14H 3W |
|----------------|-------------|--------------------|------------------|-------------------|

| | | | |
|-------------------|----------------|---------------|----------------|
| 3.7V 4.0Ah | LM 1000 | 900 | 700 |
| | 5 min | 30 min | 145 min |

| | | |
|------------------|--------------|--------------|
| 100V 240V | 5V 1A | IP 44 |
|------------------|--------------|--------------|

| | |
|-----------------|---------------|
| 6500±400 | KELVIN |
|-----------------|---------------|

| | | |
|--------------|-------------|-------------|
| 257mm | 50mm | 26mm |
|--------------|-------------|-------------|



LAMPADA PORTATILE LED

| | | | | |
|---------------|------|----|----|-----|
| 53431 | 0,35 | 10 | 40 | 400 |
| 37,50€ | Kg | | | |

| | | | | |
|---------------|------------------|----------------------------|-------------|--------------|
| 300 Lm | 7 LED SMD | Li-Ion 3.7V 2.000MA | 3-4H | 3-15H |
|---------------|------------------|----------------------------|-------------|--------------|

| | | | | |
|---------------|------|----|----|-----|
| 53432 | 0,35 | 10 | 40 | 400 |
| 41,50€ | Kg | | | |

| | | | | |
|---------------|-------------------|----------------------------|-------------|--------------|
| 500 Lm | 11 LED SMD | Li-Ion 3.7V 4.000MA | 6-7H | 3-15H |
|---------------|-------------------|----------------------------|-------------|--------------|

| | | | | |
|---------------|-----|----|----|-----|
| 53433 | 0,4 | 10 | 40 | 480 |
| 50,00€ | Kg | | | |

| | | | | |
|-----------------|-------------------|----------------------------|-------------|--------------|
| 1.000 Lm | 13 LED SMD | Li-Ion 3.7V 4.400MA | 6-7H | 3-15H |
|-----------------|-------------------|----------------------------|-------------|--------------|



53431 53433 53432



LAMPADE PORTATILI

LAMPADA LED COB CON BASE ARTICOLATA

| | | | |
|---------------|-----|----|-----|
| 53216 | 0,6 | 10 | 120 |
| 48,50€ | Kg | | |

| | | | |
|-------------------------|----------------------|-------------|----------------------|
| 200 Lm | LED 2W COB | | 5V 1.000MA |
| 3.7V 2.000MAH | 4H | 3-4H | |



LAMPADA LED COB

| | | | |
|---------------|-----|----|-----|
| 53217 | 0,3 | 20 | 620 |
| 32,00€ | Kg | | |

| | | | |
|------------------|----------------------|------------------------|----------------------|
| 200 Lm | LED 2W COB | 3.7V 2600MAH | 5V 1.000MA |
| 4H | | | |

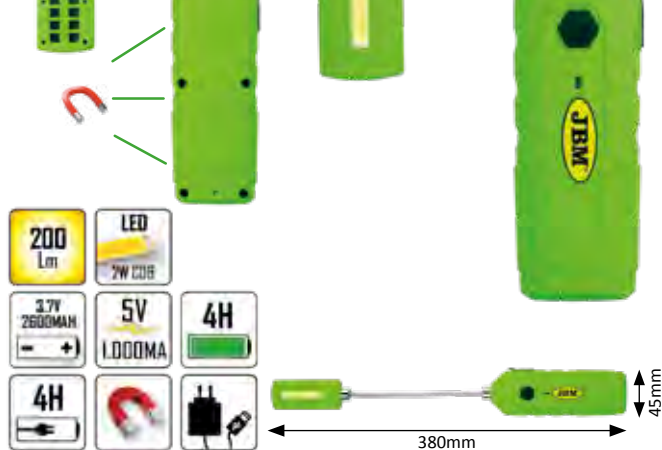

LAMPADA PORTATILE LED 200LM

| | | | | |
|---------------|------|----|----|-----|
| 53439 | 0,25 | 10 | 50 | 600 |
| 21,00€ | Kg | | | |



| | | | | | |
|------------------|-------------|---------------|--------------|-----------------------------|---------------------|
| 200 Lm | 2-3H | 2,5/5H | IP 20 | Li-Ion 3.7V 650MA | 7 LED 300 |
| 1,15m | | | | | |

LAMPADA PORTATILE DA OFFICINA A 24+6 LED CON DOPPIO MAGNETE POSTERIORE

| | | | |
|---------------|------|----|-----|
| 51889 | 0,43 | 10 | 360 |
| 44,00€ | Kg | | |



| | | |
|-----------------------|-----------------|-------------------------|
| x24 + 6 LED | 30 Lm | 3.6V 1.400MAH |
| | 1H | 8H |

LED superiore
10h. AUTONOMIA

DOPPIO GANCIO E
DOPPIO MAGNETE

PORTATILE ULTRA SOTTILE ALTA LUMINOSITA

| | | | |
|---------------|------|----|-----|
| 52384 | 0,33 | 20 | 600 |
| 35,50€ | Kg | | |

Lunghezza del cavo : 5m
Lunghezza del cavo DC: 0.1M
Lunghezza del cavo DC fino pinze : 0.3M



| | | |
|------------------|----------------------|------------------|
| 200 Lm | LED 3W COB | 12V / 24V |
| 75mm | | |

ADATTATORE DI PRESA INGLESE

| | |
|--------------|------|
| 13816 | 0,50 |
| 0,70€ | Kg |



LAMPADA PORTATILE COB FINISSIMO

N

| | | | |
|---------------|-----|-----|----|
| 53519 | 0,2 | 12 | 72 |
| 32,00€ | Kg | sub | ff |

FINISSIMO 12mm

300mm

38mm

| | | |
|-------------|------------|-------------|
| 300 Lm | LED 3W COB | 3.7V 1000MA |
| 3H | IP 44 | |
| 300LM 150LM | 2H | 4H |
| 100V 240V | 5V 0.6A | |

PORTATILE SLIMLINE COB LED CON BATTERIA

| | | | |
|---------------|-----|----|-----|
| 52536 | 0,4 | 10 | 300 |
| 46,50€ | Kg | ff | sub |

360mm

50mm

| | |
|------------------|----------------|
| 200 Lm | LED 2W COB |
| 3.7V 1.800MAH | 5-6H |
| INTENSITY 1 3.5H | INTENSITY 2 5H |

JBM REGISTERED PATENTED DESIGN

TORCIA TASCABILE CON BATTERIA

| | | | | |
|---------------|------|-----|----|-----|
| 52987 | 0,17 | 10 | 40 | 640 |
| 31,00€ | Kg | sub | ff | sub |

160mm

30mm

20mm

| | | |
|--------|------------|--------------|
| 120 Lm | LED 3W COB | 3.7V 1000MAH |
| 2,5H | 2,5H | |

LAMPADA LED COB CON BASE ARTICOLATA

| | | | |
|---------------|------|----|-----|
| 52883 | 0,31 | 20 | 640 |
| 42,00€ | Kg | ff | sub |

240mm

37mm

| | | |
|---------------|------------|--------|
| 180 + 80 Lm | LED 2W COB | |
| 3.7V 1.800MAH | 4-5H | 3,5-4H |

LAMPADE PORTATILI

ADATTATORE PER PLUG USB

N

| | | |
|--------------|------|-----|
| 13839 | 0,04 | 200 |
| 7,00€ | Kg | ff |

110V / 60HZ

USB

11107

10961

11989

11093

PRESA ACCENDISIGARI E TRASFORMATORE

| REF. | DESCRIZIONE | PER REF. | Kg | sub | ff | € |
|-------|---|----------------------------|------|-----|-----|--------|
| 11107 | PRESA 100-240V OUTPUT: 6V 500MA | 51889 | 0,06 | - | 250 | 4,50€ |
| 10961 | TRASFORMATORI PER PORTABILI 100-240V OUTPUT: 6V 500MA | 51889 | 0,08 | - | 150 | 13,50€ |
| 11989 | PRESA 100-240V OUTPUT: 9V 500MA | 52536 | 0,04 | - | 200 | 4,50€ |
| 11093 | PRESA 230V OUTPUT: 6V 500MA | 51453, 50648, 50650, 52257 | 0,06 | - | 250 | 4,50€ |
| 14031 | ADATTATORE USB PER SPINA A MURO | - | - | 10 | 100 | 6,50€ |
| 14032 | ADATTATORE USB PER PRESA ACCENDISIGARI INGRESSO: 12-24V USCITE: 5V, 1A/2.1A | - | - | 10 | 100 | 5,00€ |
| 14033 | CAVO USB LUNGHEZZA: 80CM | - | - | 10 | 100 | 2,50€ |

N

LAMPADA PORTATILE DA MANO A 37 LED CON MANICO ROTANTE

| | | | |
|---------------|------|----|-----|
| 52002 | 1,44 | 12 | 120 |
| 29,00€ | Kg | 1f | 1f |

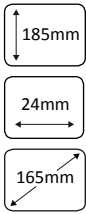

| | | |
|----------------|---------------------------|--------------------|
| x37 LED | 185 Lm | 4V 2.5AH |
| ZW | MCD: 14.000 21.000 | 7-8H 15-25H |

Fino a 500 cicli di carica.
LED a luce bianca, gran risparmio.
Elevata durata, alta luminosità.

LUCE FRONTALE DA TESTA LED CREE XPE

| | | | |
|---------------|------|----|-----|
| 52584 | 0,17 | 10 | 360 |
| 11,00€ | Kg | 1f | 1f |



| | | |
|---------------------|-------------|---------------|
| 150 Lm | 5H | x3 AAA |
| LED CREE XPE | ZOOM | 100M |

LAMPADA PORTATILE COB ULTRAVIOLETTA FLESSIBILE CON BASE MAGNETICA

N

| | | | | |
|---------------|-----|----|----|-----|
| 53530 | 0,3 | 5 | 20 | 620 |
| 43,00€ | Kg | 5f | 1f | 1f |



| | |
|-------------------|---------------------|
| 200 Lm | LED 2W COB |
| 5V 1.000MA | 3.7V 2600MAH |
| 4H | 4H |

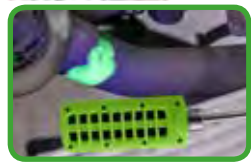

UV LED

TORCIA A UV LED PORTATILE

| | | | | |
|---------------|------|----|----|-----|
| 53451 | 0,35 | 10 | 40 | 480 |
| 40,00€ | Kg | 5f | 1f | 1f |



| | |
|---------------|---------------------------|
| 3-4H | 9/36H |
| IP 44 | Li-ion 3.7V 2000MA |
| 11 LED | 11 LED |



UV LED

UV LED

LAMPADA A LED DA TAVOLO MAGNETICA

| | | | |
|---------------|-----|----|-----|
| 53227 | 0,6 | 24 | 192 |
| 26,00€ | Kg | 1f | 1f |

Fino a 500 cicli di carica.
LED a luce bianca, gran risparmio.
Elevata durata, alta luminosità.

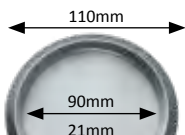

220mm

LENTE DI INGRANDIMENTO LED (5X)

| | | | | |
|---------------|------|----|----|-------|
| 53085 | 0,31 | 10 | 40 | 1.500 |
| 26,50€ | Kg | 5f | 1f | 1f |



2 POSIZIONI

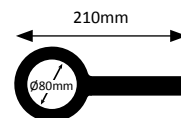

LAMPADA PORTATILE A 8 LED MAGNETIZZATA

| | | | | |
|--------------|------|----|----|-------|
| 52582 | 0,03 | 12 | 96 | 1.728 |
| 5,50€ | Kg | | | |



Acquistabile singolarmente o in espositore da 12 unità



| | | | | |
|--------------|------|----|----|-------|
| 53427 | 0,05 | 12 | 96 | 3.072 |
| 4,00€ | Kg | | | |

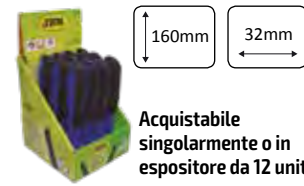

Acquistabile singolarmente o in espositore da 12 unità



LAMPADA PORTATILE 9 LED

| | | | | | |
|--------------|------|----|----|-----|-------|
| REF. | 0,03 | 12 | 72 | 144 | 3.456 |
| 3,00€ | Kg | | | | |



Acquistabile singolarmente o in espositore da 12 unità

52555



52557



52556



52558



LAMPADA PORTATILE A 9 LED

| | | | | | |
|--------------|------|----|----|-----|-------|
| 51325 | 0,04 | 12 | 72 | 144 | 3.024 |
| 3,00€ | Kg | | | | |

Articolo ausiliare.
9 Leds di lunga durata.



Acquistabile singolarmente o in espositore da 12 unità

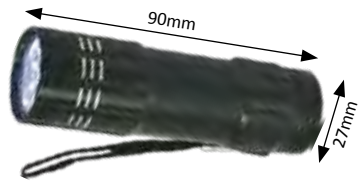

LAMPADA PORTATILE A 21 LEDS

| | | | | |
|--------------|------|----|-----|-------|
| 51326 | 0,07 | 12 | 144 | 2.880 |
| 6,00€ | Kg | | | |

Articolo ausiliare.
21 Leds di lunga durata.



Acquistabile singolarmente o in espositore da 12 unità



LAMPADA PORTATILE A DINAMO A 2 LEDS

| | | | | |
|--------------|------|----|----|-------|
| 51573 | 0,07 | 12 | 96 | 3.456 |
| 2,50€ | Kg | | | |



PRESENTAZIONE SCATOLA INDIVIDUALE

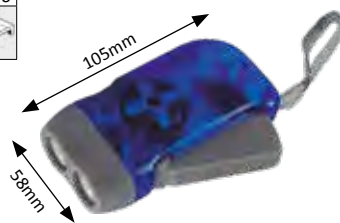

LAMPADA PORTATILE A DINAMO A 3 LEDS

| | | | | |
|--------------|------|----|----|-------|
| 51446 | 0,08 | 12 | 96 | 3.456 |
| 3,00€ | Kg | | | |



Acquistabile singolarmente o in espositore da 12 unità



PILE DI RICAMBIO

| | | | | |
|--|----------------|--------------|------|-----|
| | R14P 1,5V | 51331 | 0,09 | 240 |
| | | 0,50€ | Kg | |
| | PER REF. 51701 | 10924 | 0,05 | 12 |
| | | 5,00€ | Kg | |
| | PER REF. 50917 | | | |

| | | | | | |
|-----------|--|--------------|------|----|-------|
| | "AAA" R03 1,5V | 51258 | 0,01 | 60 | 2.400 |
| | | 0,20€ | Kg | | |
| x3 | PER REF. 51325, 51326, 51829, 52233, 51001, 52582, 52555, 52556, 52557, 52558, 52584 | | | | |

| | | | | | |
|--|-------------------------------------|--------------|------|----|-----|
| | PILA RETTANGOLARE 9V | 10923 | 0,05 | 10 | 500 |
| | | 1,50€ | Kg | | |
| | PER REF. 52162, 52450, 51929, 50942 | | | | |

PORTATILE FARO LED CON TORCIA / ALTOPARLANTE / CARICABATTERIE

| | | | |
|---------------|-----|----|-----|
| 53199 | 0,4 | 18 | 306 |
| 44,50€ | Kg | ff | |



187mm

93mm



TORCIA

CARICABATTERIE

ALTOPARLANTE



BARRA LED PIEGHEVOLE PER COFANO

| | | | |
|----------------|------|----|----|
| 53248 | 2,55 | 4 | 32 |
| 108,00€ | Kg | ff | |



FLUORESCENTE DA OFFICINA A TUBO SINGOLO

| | | | |
|---------------|-----|----|-----|
| 50515 | 0,5 | 10 | 360 |
| 15,50€ | Kg | ff | |



FLUORESCENTE DA COFANO CON SUPPORTO REGOLABILE

| | | | |
|----------------|------|----|----|
| 51230 | 2,36 | 4 | 48 |
| 105,00€ | Kg | ff | |

Fluorescente sostituibile.
Supporto allungabile.

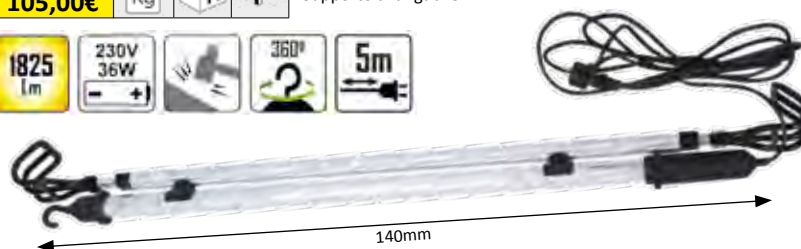

51232 68,50€
RICAMBI FLUORESCENTE
PER REF. 51230

11877 77,00€
LAMPADA SENS
GANCIO
PER REF. 51230

11092 42,00€
SUPPORTO PER
FLUORESCENTE
TOF30-31 PER REF. 51230

LAMPADA A LED DA 50W



| | | | |
|---------------|-----|----|----|
| 53505 | 2,5 | 8 | 96 |
| 53,00€ | Kg | ft | ft |



| | |
|-------------|-----------|
| 3.500 Lm | x60 LED |
| 50W | 230V 50Hz |
| +25.000h | IP 65 |
| 6500 KELVIN | 70M |
| 2m | |

TREPIEDE PER LAMPADA A LED



| | | | |
|---------------|-----|----|----|
| 53506 | 2,3 | 8 | 96 |
| 26,50€ | Kg | ft | ft |

Per ref. 53505



TREPIEDE PER LAMPADA D'ISPEZIONE PER REF. 52232

Lampada non inclusa.

| |
|---------------|
| 52254 |
| 53,50€ |

| | |
|----|------|
| Kg | 3,51 |
| ft | 1 |
| ft | 4 |
| ft | 24 |

Min: 2.770mm
Max: 1.290mm



| |
|---------------|
| 52255 |
| 43,50€ |

| | |
|----|------|
| Kg | 2,73 |
| ft | 1 |
| ft | 4 |
| ft | 80 |

Min: 1.700mm
Max: 930mm

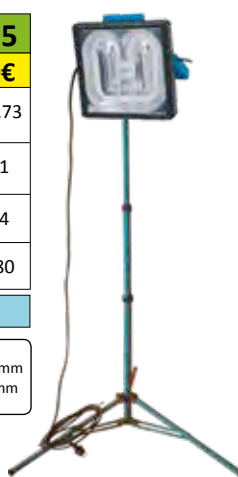

LAMPADA D'ISPEZIONE 55W QUADRATA

| | | | |
|----------------|-----|----|----|
| 52232 | 3,3 | 4 | 48 |
| 108,00€ | Kg | ft | ft |

| | |
|------------------|----|
| HERFANIT 3x1,5mm | x2 |
| 1,8m | |



RICAMBIO DI LAMPADA D'ISPEZIONE PER REF. 52232

| | | |
|---------------|------|----|
| 10982 | 0,23 | 50 |
| 16,50€ | Kg | ft |

ALLINEATORE DI FARI CON LUX METER

| | | | |
|----------------|----|----|----|
| 52740 | 24 | 1 | 10 |
| 544,50€ | Kg | ft | ft |

Distanza di misurazione: 50 cm.
Facile misurazione della deviazione dall'asse ottico dei fari di marcia diurna e dei fari anabbaglianti.
Guide di spostamento laterale opzionali.

HALOGENO / XENON / LED

| | | |
|-------|------|------|
| 156mm | 52mm | 28mm |
|-------|------|------|



LUCI LASER ALLINEAMENTO DOPPIO CON LUX METER

| | | | |
|----------------|-------|----|----|
| 52836 | 24,85 | 1 | 10 |
| 979,00€ | Kg | ft | ft |

HALOGENO / XENON / LED

| | | |
|-------|------|------|
| 156mm | 52mm | 27mm |
|-------|------|------|

REGOLAMENTO SCHERMATA DI VERIFICA



LUX METER DIGITALE



DOPPIO LASER



LAMPADE PORTATILI

LUCE ROTANTE LED BASE FLESSIBILE

| | | | | |
|---------------|-----|----|-----|------------------|
| 53454 | 0,9 | 20 | 160 | 12V - 24V |
| 51,00€ | Kg | ff | ff | |

45 PCS 2835 LED

Funzioni:

Funzione 1: FLASH

Funzione 2: LAMPEGGIO DOPPIO

Funzione 3: ROTAZIONE



CE R10 - R65

LUCE ROTANTE BASE FLESSIBILE

| | | | | |
|---------------|------|----|-----|--------------------------|
| 51964 | 0,69 | 20 | 160 | 12V 55W |
| 27,00€ | Kg | ff | ff | |

| | | | | |
|---------------|------|----|-----|--------------------------|
| 51965 | 0,68 | 20 | 160 | 24V 70W |
| 27,00€ | Kg | ff | ff | |

Lente ABS - BAES

Calotta resistente

Filo della lente con sigillatura duratura

Rpm: 40

Sistema di pignone / vite senza fine

Lampadina:

H1, 12V 55W

H1, 24V 70W

Con base a vite

Consumo di corrente: 3.0 A

| | |
|-------|--------|
| 240mm | Ø128mm |
|-------|--------|

BASE FLESSIBILE



CE R10 - R65

LUCE ROTANTE LED MAGNETIZZATO

| | | | | |
|---------------|------|----|-----|------------------|
| 53455 | 0,95 | 20 | 240 | 12V - 24V |
| 54,50€ | Kg | ff | ff | |

45 PCS 2835 LED

Magnete

Presse per accendini



Funzioni:

Funzione 1: FLASH

Funzione 2: LAMPEGGIO DOPPIO

Funzione 3: ROTAZIONE



CE R10 - R65

LUCE ROTANTE LED BASE FLESSIBILE

| | | | | |
|---------------|------|----|-----|------------------|
| 53131 | 0,82 | 20 | 160 | 12V - 24V |
| 53,00€ | Kg | ff | ff | |

Lente ABS-BAES

Calotta resistente

Consumo: 14W

Funzioni:

Funzione 1: ROTAZIONE

Funzione 2: DOPPIO FLASH

Funzione 3: 6 LAMPEGGIA

| | |
|-------|--------|
| 250mm | Ø140mm |
|-------|--------|



BASE FLESSIBILE

CE

14080 00,00€
COPERCHIO PER LAMPEGGIANTI PER REF. 53131

R10 - R65

Omologato E9 10R-046919
CE R10-R65

LUCE ROTANTE LED BASE FLESSIBILE

| | | | | |
|---------------|------|----|-----|------------------|
| 52549 | 0,71 | 20 | 200 | 12V - 24V |
| 68,50€ | Kg | ff | ff | |

Lente in policarbonato

Calotta resistente

Consumo: 17W

Funzioni:

Funzione 1: UN FLASH

Funzione 2: DOPPIO FLASH

Funzione 3: ROTAZIONE

| | |
|-------|--------|
| 208mm | Ø129mm |
|-------|--------|



BASE FLESSIBILE

ECE - R65

CE

LUCE ROTANTE SENZA CAVO

| | | | | |
|---------------|------|----|-----|--------------------------|
| 51962 | 0,58 | 20 | 240 | 12V 35W |
| 23,50€ | Kg | ff | ff | |

| | | | | |
|---------------|------|----|-----|--------------------------|
| 51963 | 0,59 | 20 | 240 | 24V 55W |
| 27,50€ | Kg | ff | ff | |

Lente ABS - BAES

Calotta resistente

Filo della lente con sigillatura duratura

Rpm: 40

Sistema di pignone / vite senza fine

Lampadina: H1, 12V 55W / H1, 24V 70W

Consumo di corrente: 3.0 A

| | |
|-------|--------|
| 170mm | Ø140mm |
|-------|--------|



R10 - R65 **CE**

LUCE ROTANTE LAMPEGGIANTE LED

| | | | | |
|---------------|-----|----|-----|------------------|
| 53130 | 0,9 | 20 | 240 | 12V - 24V |
| 53,00€ | Kg | ff | ff | |

Lente ABS-BAES

Calotta resistente

Cavo: Spirale di 2,5m con alimentazione dall'accendisigari

Consumo: 14W

Led de flusso

Funzioni:

Funzione 1: ROTAZIONE

Funzione 2: DOPPIO FLASH

Funzione 3: 6 LAMPEGGI

| | |
|-------|--------|
| 160mm | Ø140mm |
|-------|--------|



14080 10,00€
COPERCHIO PER LAMPEGGIANTI PER REF. 53130

R10 - R65

CE

LUCE ROTANTE BASSO MAGNETIZZATA

| | | | |
|---------------|------|----|-----|
| 52299 | 0,72 | 20 | 320 |
| 33,00€ | Kg | ff | ff |

12 - 55V

DESIGN COMPATTO

Lente ABS - BAES
Calotta resistente
Filo della lente con sigillatura duratura
Rpm: 40
Sistema di pignone / vite senza fine
Lampadina H3, 12V 55W
Cavo: Spirale di 3,5m + alimentazione dall'accendisigari
Consumo di corrente: 3.0 A



| | |
|-------|--------|
| 130mm | Ø128mm |
|-------|--------|

R10 - R65 CE

FARO LAMPEGGIANTE

| | | | |
|---------------|------|----|-----|
| 51966 | 0,31 | 50 | 750 |
| 20,00€ | Kg | ff | ff |

12 - 110V

FILETTATO BASE TULIPA

Lente ABS - BAES
XENON
Consumo di corrente: 3.0 A

| | | |
|-------|-------|-------|
| 131mm | Ø99mm | Ø61mm |
|-------|-------|-------|



CE R10

LUCE ROTANTE ATTACCO VELOCE

| | | | |
|---------------|------|----|-----|
| 52300 | 0,63 | 20 | 200 |
| 35,50€ | Kg | ff | ff |

12V
55W

DESIGN COMPATTO

Lente ABS - BAES
Calotta resistente
Filo della lente con sigillatura duratura
Rpm: 40
Sistema di trasmissione a cinghia
Lampadina: H3, 12V 55W
Con base a vite
Consumo di corrente: 3.0 A



R10 - R65 CE

| | |
|-------|--------|
| 210mm | Ø128mm |
|-------|--------|

LUCE ROTANTE LAMPEGGIANTE LED PROFILO BASSO

| | | |
|------|----|-----|
| 0,44 | 20 | 320 |
| Kg | ff | ff |

12V - 24V

| | | |
|------|-------|------|
| 95mm | 129mm | 85mm |
|------|-------|------|

3 interruttori di funzione
3 modalità lampeggiante:
ROTAZIONE
6 LAMPEGGI
DOPPIO FLASH



| | |
|--------------|---------------|
| 52827 | 41,00€ |
|--------------|---------------|

| | |
|--------------|---------------|
| 52910 | 41,50€ |
|--------------|---------------|

| | |
|--------------|---------------|
| 52946 | 41,50€ |
|--------------|---------------|

| | |
|--------------|---------------|
| 52828 | 41,00€ |
|--------------|---------------|

R10 CE

LUCE ROTANTE LED BASE FLESSIBILE

| | | | |
|---------------|------|----|-----|
| 52456 | 0,59 | 20 | 160 |
| 40,00€ | Kg | ff | ff |

12V - 24V

LED 6 IN 1

Lente ABS-BAES
Calotta resistente
Consumo: 8W

Funzioni:
Funzione 1: ROTAZIONE
Funzione 2: DOPPIO FLASH
Funzione 3: 6 LAMPEGGIA



| | | |
|-------|--------|-------|
| 190mm | Ø128mm | Ø24mm |
|-------|--------|-------|

BASE FLESSIBILE



CE R10

LUCE ROTANTE CON CAVO MAGNETIZZATO

| | | | |
|---------------|------|----|-----|
| 51960 | 0,80 | 20 | 240 |
| 30,00€ | Kg | ff | ff |

12V
55W

| | | | |
|---------------|------|----|-----|
| 51961 | 0,78 | 20 | 240 |
| 31,00€ | Kg | ff | ff |

24V
70W

Lente ABS - BAES
Calotta resistente
Filo della lente con sigillatura duratura
Rpm: 40
Sistema di pignone / vite senza fine
Lampadina: H1, 12V 55W / H1, 24V 70W
Cavo: Spirale de 3m + toma de alimentazione dall'accendisigari
Consumo di corrente: 3.0 A



| | |
|-------|--------|
| 160mm | Ø128mm |
|-------|--------|

R10 - R65 CE

LUCE ROTANTE LAMPEGGIANTE LED

| | | | |
|---------------|------|----|-----|
| 52375 | 0,68 | 20 | 240 |
| 40,00€ | Kg | ff | ff |

LED 6 IN 1 12V - 24V

Lente ABS-BAES
Calotta resistente
Cavo: Spirale di 2,5m + alimentazione dall'accendisigari
Consumo: 9W

Funzioni:
Funzione 1: ROTAZIONE
Funzione 2: DOPPIO FLASH
Funzione 3: 6 LAMPEGGI

| | |
|-------|--------|
| 160mm | Ø140mm |
|-------|--------|

R10 CE



LUCE ROTANTE LAMPEGGIANTE LED BASE MAGNETICA

| | | | |
|---------------|------|----|-----|
| 52499 | 0,61 | 20 | 320 |
| 46,50€ | Kg | ff | ff |

12V - 24V

| | |
|-------|--------|
| 140mm | Ø128mm |
|-------|--------|

Lente ABS-BAES
Calotta resistente
Cavo: Spirale di 2,5m + alimentazione dall'accendisigari
Consumo: 3W

Funzioni:
Funzione 1: ROTAZIONE
Funzione 2: DOPPIO LAMPEGGIO
Funzione 3: 6 LAMPEGGI

LED 6 IN 1



CE R10

AVVISATORE ACUSTICO 12V-80V

| | | | | |
|---------------|-----|-----|----|-------|
| 51967 | 0,3 | 10 | 50 | 1.200 |
| 16,00€ | Kg | 5x6 | ff | ff |

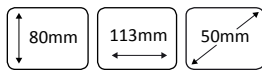

| | | | | |
|---------------|------|-----|----|-------|
| 51968 | 0,23 | 10 | 50 | 1.000 |
| 16,00€ | Kg | 5x6 | ff | ff |

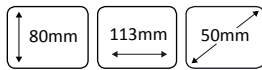

Multivoltaggio 12 - 80 V DC - 97 dB.
Resistente a diverse condizioni climatiche.
Possibilità di lavaggio con acqua a pressione.
Protetto dall'inversione di polarità.
Sigillato con resina epossidica.
Temperature sopportate: da -30 a 70 °C.



51967



51968

CONNETTORI DA ASTA

PER REF. 51964, 51965,
52300, 52456, 52549, 53131

| | |
|---------------|------|
| 10750 | |
| 14,50€ | |
| Kg | 0,25 |
| ff | 50 |



PER REF. 51964, 51965,
52300, 52456, 52549, 53131

| | |
|---------------|------|
| 10751 | |
| 16,50€ | |
| Kg | 0,33 |
| ff | 50 |

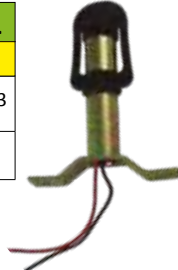

LAMPADA DI RICAMBIO

PER REF. 51966

| | |
|--------------|------|
| 11103 | |
| 5,50€ | |
| Kg | 0,01 |
| ff | 1 |



PER REF. 51960, 51962, 51964

| | |
|--------------|------|
| 10766 | |
| 3,50€ | |
| Kg | 0,02 |
| ff | 200 |



BARRA TELESCOPICA PER LUCE ROTANTE

| | | | |
|---------------|------|----|-------|
| 52843 | 1,03 | 20 | 1.500 |
| 28,00€ | Kg | ff | ff |

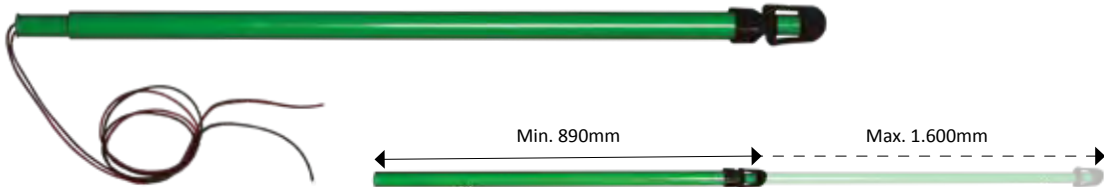

FARO LED

| | | | |
|---------------|------|----|-----|
| 53163 | 0,35 | 20 | 700 |
| 37,00€ | Kg | ff | ff |

12V - 24V

INPUT: DC12-24V
OUTPUT: DC5.8V 500mA

| | |
|---------------|------|
| IS LED FREE | x9 |
| IP 56 | 1,5H |
| 120 Flash/min | 4H |
| 110mm | 90mm |



COPERCHIO PER LAMPEGGIANTI PER REF. 51960, 51962, 51964

Carlotta resistente.

| | | |
|---------------|------|----|
| 51969 | 0,12 | 50 |
| 15,50€ | Kg | ff |
| 11324 | 0,13 | 50 |
| 19,50€ | Kg | ff |
| 11325 | 0,12 | 50 |
| 19,50€ | Kg | ff |



LUCE DI SICUREZZA PER CARRELLI ELEVATORI

N

53516

58,50€

| | |
|----|-----|
| Kg | 0,7 |
| ft | 20 |
| ft | 300 |

10V
30V

10W



95mm

150mm

115mm



Supporto universale

Fanale di sicurezza ovale a 2 LED blu. Il fanale proietta sul suolo la luce blu diretta come segnale di avvertimento ai passanti.

Tale luce di avvertimento permette di evitare collisioni e incidenti in cui possano essere coinvolti carrelli elevatori e persone ed aumenta il livello di sicurezza in condizioni di lavoro, specie nelle cosiddette zone morte. Ideale per ambienti rumorosi.



LAMPADA DA LAVORO LED LUCE DIFFUSA

52566

27,50€

| | | |
|------|----|-----|
| 1,09 | 10 | 360 |
| Kg | ft | ft |



165mm

117mm

45mm

52567

27,50€

| | | |
|------|----|-----|
| 1,02 | 10 | 400 |
| Kg | ft | ft |



170mm

Ø127mm

45mm

1.450
Lm



x9 LED
3W

ALU

10-30V
27W

IP 68

+30.000H



75mm

FANALI DA LAVORO

LAMPADA DA LAVORO LED LUCE DIFFUSA

52302

22,00€

| | | | |
|------|----|----|-----|
| 0,84 | 5 | 20 | 640 |
| Kg | ft | ft | ft |



140mm

117mm

45mm

52303

22,00€

| | | | |
|------|----|----|-----|
| 0,76 | 5 | 20 | 640 |
| Kg | ft | ft | ft |



140mm

Ø123mm

45mm

1.450
Lm



x9 LED
3W

ALU

10-30V
27W

IP 68

+30.000H



LAMPADA DA LAVORO LED LUCE CONCENTRATA

52415

18,50€

| | | | |
|-----|----|----|-----|
| 0,6 | 5 | 20 | 640 |
| Kg | ft | ft | ft |



140mm

117mm

45mm

52414

18,50€

| | | | |
|------|----|----|-----|
| 0,78 | 5 | 20 | 640 |
| Kg | ft | ft | ft |



140mm

Ø127mm

45mm

1.450
Lm



x9 LED
3W

ALU

10-30V
27W

IP 68

+30.000H



LAMPADA DA LAVORO LED LUCE CONCENTRATA

| | | | | | | | |
|---------------|------|----|-----|--|-------|-------|------|
| 52568 | 1,17 | 10 | 400 | | 165mm | 117mm | 45mm |
| 27,50€ | | | | | | | |

| | | | | | | | |
|---------------|------|----|-----|--|-------|--------|------|
| 52569 | 1,04 | 10 | 400 | | 170mm | Ø127mm | 45mm |
| 27,50€ | | | | | | | |

| | | | | | | | |
|-----------------|--|------------------|------------|-------------------|--------------|-----------------|--|
| 1.450 Lm | | x9 LED 3W | ALU | 10-30V 27W | IP 68 | +30.000H | |
|-----------------|--|------------------|------------|-------------------|--------------|-----------------|--|



75mm

LAMPADA DA LAVORO LED LUCE DIFFUSA

| | | | | | | | | |
|---------------|-----|---|----|-----|--|-------|-------|------|
| 53428 | 0,5 | 5 | 20 | 480 | | 140mm | 117mm | 45mm |
| 14,50€ | | | | | | | | |

| | | | | | | | | |
|---------------|-----|---|----|-----|--|-------|--------|------|
| 53429 | 0,4 | 5 | 20 | 480 | | 140mm | Ø127mm | 45mm |
| 14,50€ | | | | | | | | |

| | | | | |
|-----------------|--|---------------|------------------|-----------------|
| 1.450 Lm | | x9 LED | 9-30V 27W | +30.000H |
|-----------------|--|---------------|------------------|-----------------|



LAMPADA DA LAVORO LED LUCE DIFFUSA

| | | | | | | | |
|---------------|------|----|-----|--|-------|-------|------|
| 53049 | 1,53 | 10 | 468 | | 118mm | 123mm | 87mm |
| 93,50€ | | | | | | | |

| | | | | | | | |
|-----------------|--|-------------------|------------|------------------|--------------|-----------------|--|
| 3.600 Lm | | x4 LED 10W | ALU | 9-36V 40W | IP 68 | +30.000H | |
|-----------------|--|-------------------|------------|------------------|--------------|-----------------|--|



LAMPADA DA LAVORO LED LUCE DIFFUSA

| | | | | |
|---------------|---|----|-----|--|
| 53045 | 1 | 12 | 504 | |
| 42,50€ | | | | |

| | | |
|-------|-------|------|
| 155mm | 127mm | 55mm |
|-------|-------|------|

| | | | | | | |
|-----------------|--|-------------------|------------|------------------|--------------|-----------------|
| 2.880 Lm | | x16 LED 3W | ALU | 9-36V 48W | IP 68 | +30.000H |
|-----------------|--|-------------------|------------|------------------|--------------|-----------------|



LAMPADA DA LAVORO LED LUCE DIFFUSA

| | | | | |
|---------------|------|----|-----|--|
| 53046 | 0,74 | 12 | 480 | |
| 37,50€ | | | | |

| | | |
|-------|-------|--------|
| 139mm | 128mm | 48.5mm |
|-------|-------|--------|

| | | | | | | |
|-----------------|--|---------------------|------------|------------------|--------------|-----------------|
| 2.272 Lm | | x16 LED 1,5W | ALU | 9-36V 24W | IP 68 | +30.000H |
|-----------------|--|---------------------|------------|------------------|--------------|-----------------|



LAMPADA DA LAVORO LED LUCE CONCENTRATA

| | | | |
|----------------|------|---|-----|
| 53051 | 2,75 | 6 | 468 |
| 186,50€ | Kg | | |



LAMPADA DA LAVORO LED LUCE CONCENTRATA

| | | | | | | |
|----------------|------|---|----|-------|-------|-------|
| 53047 | 3,51 | 4 | 40 | 230mm | 185mm | 150mm |
| 292,50€ | Kg | | | | | |



VELOCITÀ DI MOVIMENTO
REGOLABILE



LAMPADA DA LAVORO LED LUCE DIFFUSA

| | | | |
|----------------|------|---|-----|
| 53052 | 2,75 | 6 | 468 |
| 186,50€ | Kg | | |



LAMPADA DA LAVORO LED LUCE DIFFUSA

| | | | | | | |
|---------------|------|----|-----|-------|-------|------|
| 53050 | 1,53 | 10 | 468 | 118mm | 123mm | 87mm |
| 93,50€ | Kg | | | | | |



LAMPADA DA LAVORO LED LUCE CONCENTRATA

| | | | | | | |
|---------------|-----|----|-------|-------|-------|------|
| 53048 | 1,5 | 10 | 1.000 | 118mm | 123mm | 87mm |
| 93,50€ | Kg | | | | | |



BARRA PER RIMORCHIO, 2 LUCI E 2 CATARIFRANGENTI TRIANGOLARI CAVO DI 5m

| | | | | | | |
|---------------|------|---|----|-------|--------|----------------|
| 50910 | 2,14 | 6 | 54 | 140mm | 1100mm | Material: HDPE |
| 43,00€ | Kg | | | | | |



LED

| | | | | | | | |
|---------------|------|---|---|----|-------|--------|-----|
| 52838 | 1,96 | 1 | 6 | 54 | 140mm | 1100mm | 12V |
| 59,00€ | Kg | | | | | | |



Material: HDPE
Omologato E4 7R-0218756

BARRA PORTALUCI PER RIMORCHIO ESTENSIBILE RIFLETTENTE 1,4 a 2,1m CAVO DI 6m

| | | | | | |
|---------------|------|---|----|------|------|
| 52458 | 3,45 | 6 | 36 | 1,4m | 2,1m |
| 52,00€ | Kg | | | | |



LED

| | | | | | | | |
|---------------|------|---|---|----|------|------|-----|
| 52848 | 2,49 | 1 | 6 | 36 | 1,4m | 2,1m | 12V |
| 83,50€ | Kg | | | | | | |



Omologato E4 7R-0218756

KIT LUCI MAGNETICO CON 2 LUCI + 2 CATARIFRANGENTI

| | | | |
|-------|-------|------|----------------------------------|
| 118mm | 123mm | 87mm | Cavo piatto: 7m Spirale: 2,5m |
|-------|-------|------|----------------------------------|

| | | | |
|---------------|------|---|----|
| 51886 | 1,47 | 8 | 96 |
| 46,50€ | Kg | | |



LED

| | | | | | |
|---------------|------|---|----|-----|--|
| 52839 | 1,47 | 8 | 96 | 12V | |
| 61,50€ | Kg | | | | |



Omologato E4-7R-0218756

LAMPADA LED PER BARRA DI RIMORCHIO

| | | | | | |
|---------------|-----|---|----|-----|-----|
| 53151 | 0,2 | 5 | 20 | 900 | 12V |
| 14,00€ | Kg | | | | |

| | | |
|------|-------|------|
| 99mm | 100mm | 39mm |
|------|-------|------|



4 funzioni:

- Blu: Posizione e matricola
- Rosso: Luce del freno.
- Giallo: Intermitente
- Bianco: Massa

BARRA PER RIMORCHIO

TESTER DELLE LUCI DEL RIMORCHIO 7 POLI

| | | | |
|---------------|-----|----|-------|
| 51929 | 0,2 | 26 | 1.144 |
| 23,50€ | Kg | | |

Questo tester indica rapidamente se ci sono danni nel cablaggio sia del veicolo che del rimorchio. È utile anche per il controllo di roulotte e di supporti per biciclette.

PRESA RIMORCHI PRESA VEICOLO



12V
CE

TESTER DELLE LUCI DEL RIMORCHIO 13 POLI

| | | | | |
|----------------|------|----|----|-----|
| 52741 | 1,59 | 15 | 64 | 12V |
| 198,00€ | Kg | | | |

Questo tester ha una presa laterale per la connessione della spina a 13 poli del rimorchio e nell'altro una per collegare la spina a 13 poli del veicolo.



CE

MINI ASTUCCIO DI LAMPADE

| | | | |
|------|----|-----|-------|
| 0,09 | 10 | 100 | 1.500 |
| | | | |

12V H1



51613
3,00€

H4



52047
6,50€

51614
3,50€

H7



52048
6,00€

50431
3,50€

12V H7+H1



50915
4,50€

12V HB3



50523
5,00€

12V HB4



50524
5,00€

12V H9



51615
6,50€

12V H11



51612
6,50€

LAMPADINE PER AUTO

ARMADIO DI LAMPADE BER BERLINE

| | | | |
|----------------|------|---|----|
| 50551 | 9,39 | 1 | 18 |
| 275,00€ | | | |

Luce d'arresto a 1 polo

P21W 21 W BA15s unità 30
P21WA 21 W BA15s
Arancione unità 10
PY21W 21 W BAU15s
Ambo Sc. unità 10

Luce d'arresto a 2 poli

R21/5W 21/5 W BAY15d unità 40

PLAFONIERA

C5W 5 W SV8.5 11x38 unità 22

Lampade spia

R5W 5 W BA15s unità 30
R10W 10 W BA15s unità 30

Indicatori di direzione

T4W 4 W BA9s unità 22

Lampade alogene

H1 55 W P14.5s unità 10
H2 55 W X511 unità 4
H3 55 W PK22s unità 4
H4 60/55 W P43t unità 10
H7 55 W PX26d unità 10
HB3 65 W P20d unità 4
HB4 55 W P20d unità 4
H9 65 W PGJ19-5 unità 4
H11 65 W PGJ19-2 unità 4

Illuminazione europea

T5 1,2 W W2,1x4,6d unità 20
T10 5 W W2.1x9,6d unità 12
T10 3 W W2.1x9,6d unità 12
T13 10 W W2.1x9,6d unità 10
T15 18 W W2.1x9,6d unità 10
T20 21 W W5x16d unità 10
T20A 21 W W5x16d Arancione 10u.
T20 21/5 W W5x16d unità 10

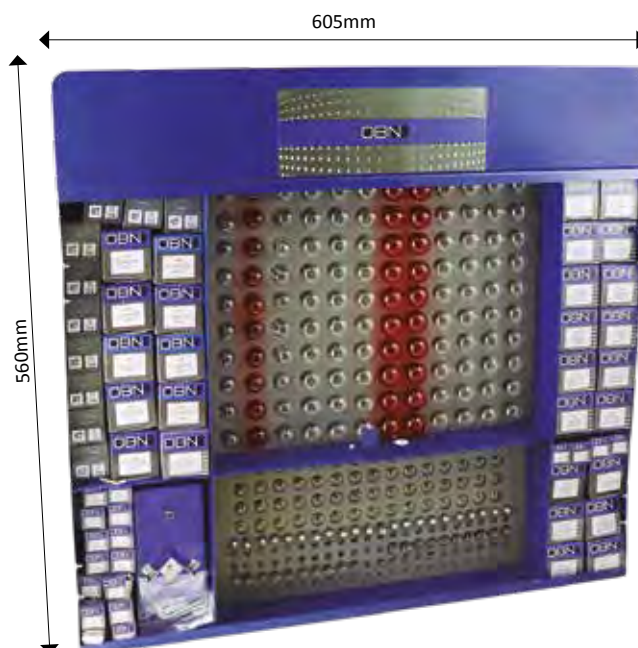

LAMPADE OBN

H7

| | | | | |
|--------------|------|----|-----|-------|
| 52365 | 0,01 | 10 | 200 | 9.000 |
| 4,00€ | Kg | | | |

V: 12V, W: 55W,
Imballo: Scatola
1pz

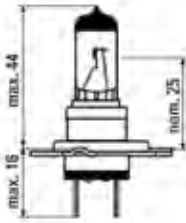

H4

| | | | | |
|--------------|------|----|-----|-------|
| 52364 | 0,02 | 10 | 200 | 4.400 |
| 4,50€ | Kg | | | |

V: 12V, W: 60/55W,
Imballo: Scatola 1pz

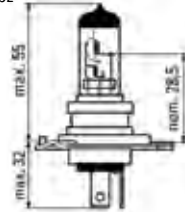

H1

| | | | | |
|--------------|------|----|-----|--------|
| 52362 | 0,01 | 10 | 200 | 14.400 |
| 2,00€ | Kg | | | |

V: 12V, W: 55W,
Imballo: Scatola 1pz

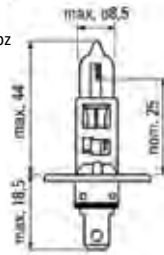

BA15S

| | | | | |
|--------------|-----|----|-----|--|
| 52303 | 0,1 | 10 | 200 | |
| 0,50€ | Kg | | | |

V: 12V
W: 21W

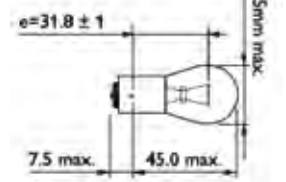

H1 55W

| | | | |
|--------------|------|-----|--|
| 10766 | 0,02 | 200 | |
| 3,50€ | Kg | | |

12V, W: 55W,
Imballo: Scatola 1pz

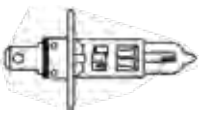

H3

| | | | | |
|--------------|------|----|-----|--------|
| 52363 | 0,02 | 10 | 200 | 14.400 |
| 2,00€ | Kg | | | |

V: 12V, W: 55W,
Imballo: Scatola 1pz

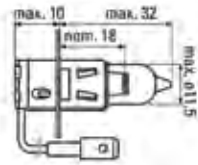

1 POLO

| | | | | |
|--------------|------|----|-----|--------|
| 52366 | 0,01 | 10 | 200 | 14.400 |
| 1,00€ | Kg | | | |

V: 12V, W: 21W,
Imballo: Scatola 10pz
Attacco BA15s

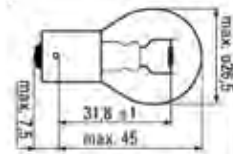

2 POLOS

| | | | | |
|--------------|------|----|-----|--------|
| 52367 | 0,01 | 10 | 200 | 14.400 |
| 1,00€ | Kg | | | |

V: 12V, W: 21/55W,
Imballo: Scatola 10pz
Attacco BAY15d

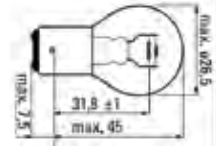

2 POLOS

| | | | | |
|--------------|------|----|-------|------|
| 52369 | 0,01 | 10 | 1.000 | 18.0 |
| 2,00€ | Kg | | | |

V: 12V, W: 21/55W,
Imballo: Scatola 10pz.
Senza attacco T20

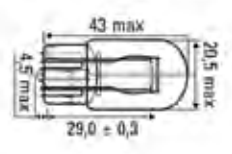

PLAFONIER

| | | | | |
|--------------|------|----|-------|--------|
| 52371 | 0,01 | 10 | 2.000 | 24.400 |
| 0,50€ | Kg | | | |

V: 12V, W: 5W,
Imballo: Scatola 10pz
Attacco SV8,3 11x31

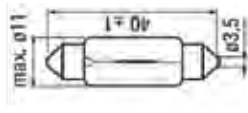

PLAFONIER

| | | | | |
|--------------|------|----|-------|--------|
| 52410 | 0,01 | 10 | 2.000 | 24.000 |
| 0,50€ | Kg | | | |

V: 12V, W: 5W,
Imballo: Scatola 10pz
Attacco SV8,5 11x38

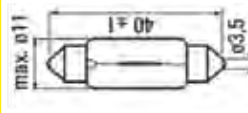

WEDGE T5

| | | | | |
|--------------|------|----|-------|--|
| 52859 | 0,01 | 10 | 5.000 | |
| 0,50€ | Kg | | | |

V: 12V, W: 1,2W, T5
Imballo: Scatola 10pz
W2x4,6d

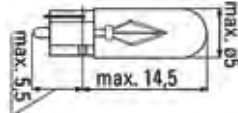

WEDGE T10

| | | | | |
|--------------|------|----|-------|--|
| 52860 | 0,01 | 10 | 5.000 | |
| 0,50€ | Kg | | | |

V: 12V, W: 3W, T10
Imballo: Scatola 10pz
W2,1x9,5d

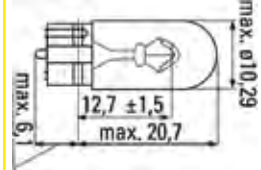

WEDGE T10

| | | | | |
|--------------|------|----|-------|--|
| 52861 | 0,01 | 10 | 5.000 | |
| 0,50€ | Kg | | | |

V: 12V, W: 5W,
T10 Imballo: Scatola 10pz
W2,1x9,5d

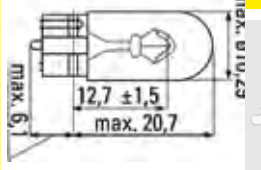

WEDGE T20

| | | | | |
|--------------|------|----|-------|--|
| 52862 | 0,01 | 10 | 1.000 | |
| 2,00€ | Kg | | | |

V: 12V, W: 21W,
Imballo: Scatola 10pz
W3x16d

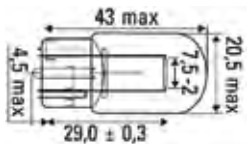

WEDGE T20

| | | | | |
|--------------|------|----|-------|--|
| 52863 | 0,01 | 10 | 1.000 | |
| 2,00€ | Kg | | | |

V: 12V, W: 21W,
Imballo: Scatola 10pz
WX3x16d

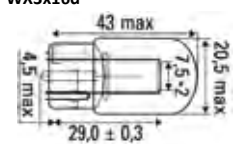

R5W

| | | | | |
|--------------|------|----|-----|--|
| 53007 | 0,01 | 10 | 200 | |
| 0,50€ | Kg | | | |

V: 12V, W: 5W, T16
Imballo: Scatola 10pz
Attacco BA15S

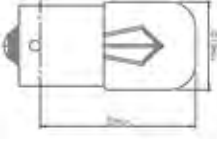

BAZ15D

| | | | | |
|--------------|------|----|-------|--|
| 52868 | 0,01 | 10 | 1.000 | |
| 0,50€ | Kg | | | |

V: 12V, W: 21/4W,
Imballo: Scatola 10pz
Attacco BAZ15D

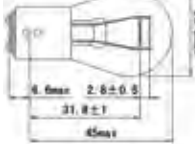

BAU15S

| | | | | |
|--------------|------|----|-------|--|
| 52867 | 0,01 | 10 | 1.000 | |
| 1,00€ | Kg | | | |

V: 12V, 21W, BAU15S
Imballo: Scatola 10pz
Attacco BAU15s

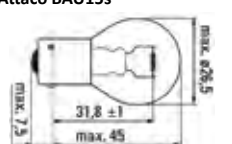

T20A

| | | | | |
|--------------|------|----|-------|--------|
| 52368 | 0,01 | 10 | 1.000 | 18.000 |
| 2,00€ | Kg | | | |

V: 12V, W: 21W,
Imballo: Scatola 10pz. Senza attacco

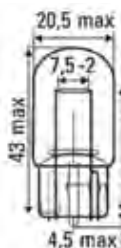

T20

| | | | | |
|--------------|------|----|-------|--------|
| 52370 | 0,01 | 10 | 1.000 | 18.000 |
| 2,00€ | Kg | | | |

V: 12V, W: 21W,
Imballo: Scatola 10pz. Senza attacco

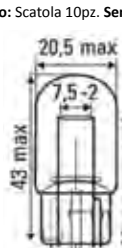

T20

| | | | | |
|--------------|------|----|-------|--|
| 52864 | 0,01 | 10 | 1.000 | |
| 2,00€ | Kg | | | |

V: 12V, W: 21/5W,
Imballo: Scatola 10pz
W3x16q

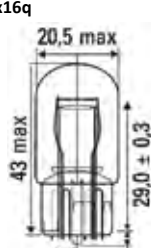

T13

| | | | | |
|--------------|------|----|-------|--|
| 52865 | 0,01 | 10 | 2.000 | |
| 0,50€ | Kg | | | |

V: 12V, W: 10W, T13
Imballo: Scatola 10pz
Senza attacco

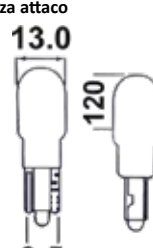

T15

| | | | | |
|--------------|------|----|-------|--|
| 52866 | 0,01 | 10 | 2.000 | |
| 0,50€ | Kg | | | |

V: 12V, W: 18W, T15
Imballo: Scatola 10pz
Attacco

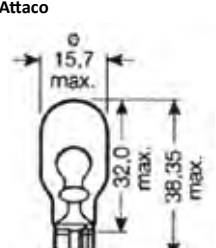



UTENSILI PNEUMATICI

| | |
|------------------------------------|---------------|
| AVVITATORE PNEUMATICO. | 93 - 98 - 100 |
| PER VEICOLI PESANTI. | 95 |
| TRAPANO | 95 - 99 - 101 |
| SMERIGLIATRICE | 95 - 98 - 101 |
| CRICCHETTO | 95 - 101 |
| TAGLIATRICE. | 96 - 99 - 102 |
| AVVITATRICE PER DADI ELETTRICO . . | 97 |
| LEVIGATRICE | 99 |
| PLATORELLI. | 102 |
| ESPOSITORI. | 102 |
| PISTOLA AD ARIA. | 103 |
| FILTRI | 105 |
| ADATTATORI / ATTACCHI . . | 105 |
| AVVOLGITUBO DELL'ARIA . . . | 106 |



AVVITATORE PNEUMATICO 1/2" COMPOSITE **1756Nm**

N

| | | | | |
|----------------|-----|-----|----|-----|
| 53520 | 2,4 | 5 | 10 | 160 |
| 218,00€ | Kg | Sub | ff | ff |

COMPOSITE



| | | | |
|------------|-------|----------|-----------|
| 1/2" | MAX | 1756 Nm | 7.000 RPM |
| 66-1112 Nm | 1,9kg | 1/4" | |
| 83 dBa | 183mm | x3 SPEED | |

AVVITATORE PNEUMATICO 1/2" **1356Nm**

| | | | | |
|----------------|------|-----|----|-----|
| 52981 | 1,96 | 5 | 10 | 300 |
| 218,00€ | Kg | Sub | ff | ff |



| | | | | | | |
|----------|-----------|------------|-----------|----------|-----------|----------|
| 1/2" | MAX | 1356 Nm | 5.000 RPM | 1.917 Nm | 5.000 RPM | 1.671 Nm |
| 1,8kg | 1/4" | 94 dBa | 145mm | 120mm | | |
| x6 SPEED | 2.8(m/s²) | 0,2 m³/min | | | | |

AVVITATORE PNEUMATICO MINI DA 1/2" COMPOSITE **1302Nm**

| | | | | |
|----------------|------|-----|----|-----|
| 51206 | 1,46 | 5 | 10 | 150 |
| 229,00€ | Kg | Sub | ff | ff |

COMPOSITE



| | | | |
|-----------|----------|---------|------------|
| 1/2" | MAX | 1302 Nm | 11.000 RPM |
| 34-524 Nm | 1,2kg | 1/4" | |
| 83 dBa | x3 SPEED | | |

AVVITATORE PNEUMATICO NANO DA 1/2" **678Nm**

| | | | | |
|----------------|------|-----|----|-----|
| 52790 | 1,51 | 5 | 10 | 300 |
| 185,00€ | Kg | Sub | ff | ff |



| | | | | | | |
|------|--------|--------|------------|-----------|------------|--------|
| 1/2" | MAX | 678 Nm | 10.000 RPM | 565 Nm | 10.000 RPM | 542 Nm |
| 1/4" | 94 dBa | 90 mm | x6 SPEED | 2.8(m/s²) | | |

AVVITATORE PNEUMATICO NANO DA 1/2" **1070Nm**

| | | | | |
|----------------|------|-----|----|-----|
| 53460 | 1,65 | 5 | 10 | 300 |
| 218,00€ | Kg | Sub | ff | ff |



| | | | |
|------------|--------|----------|------|
| 1/2" | MAX | 1070 Nm | |
| 18.500 RPM | 870 Nm | 1,4kg | 1/4" |
| 85 dBa | 113 mm | x6 SPEED | |

AVVITATORE PNEUMATICO DA 1/2" DOPPIO BLISTER **101Nm**

| | | | |
|----------------|------|----|-----|
| 51222 | 1,09 | 20 | 240 |
| 109,00€ | Kg | ff | ff |



| | | | |
|---------|-------|---------|------------|
| 1/2" | MAX | 101 Nm | 10.000 RPM |
| 7-68 Nm | 0,9kg | 6.3 bar | |
| 1/4" | 360° | 85 L/m | |



TRASMISSIONE A FARFALLA

**KIT AVVITATORE PNEUMATICO DA 1/2"
COMPOSITE + BUSSOLE**

1756Nm



| | | | |
|----------------|------|---|----|
| 51207 | 3,95 | 5 | 80 |
| 286,00€ | Kg | | |

COMPOSITE



17, 19, 21mm



**AVVITATORE PNEUMATICO
DA 3/4" COMPOSITE**

2034Nm

| | | | |
|----------------|------|---|----|
| 51212 | 3,77 | 4 | 60 |
| 539,00€ | Kg | | |

COMPOSITE



**AVVITATORE PNEUMATICO
DA 1" COMPOSITE**

2034Nm

| | | | |
|----------------|------|---|----|
| 51211 | 3,86 | 4 | 60 |
| 572,00€ | Kg | | |

COMPOSITE



**AVVITATORE PNEUMATICO DA 3/4"
+ PROLUNGA DI 15cm COMPOSITE**

2034Nm

| | | | |
|----------------|------|---|----|
| 51210 | 4,49 | 4 | 60 |
| 658,00€ | Kg | | |

COMPOSITE



**AVVITATORE PNEUMATICO DA 1"
+ PROLUNGA DI 12cm COMPOSITE**

2034Nm

| | | | |
|----------------|------|---|----|
| 51213 | 4,77 | 4 | 60 |
| 691,00€ | Kg | | |

COMPOSITE



AVVITATORE PNEUMATICO AD IMPULSI PER VEICOLI PESANTI 1"

3260Nm

| | | | |
|----------------|------|---|----|
| 52814 | 23,5 | 1 | 20 |
| 493,00€ | Kg | | |

Uscita: laterale.
Facile serraggio regolazione della velocità e allentamento.

| | | | |
|----------|----------------|----------------------|------|
| 1" | MAX 3260 Nm | 3.600 RPM | 1/2" |
| x6 SPEED | 424 L/m | 25 m ³ /h | |

32, 33mm

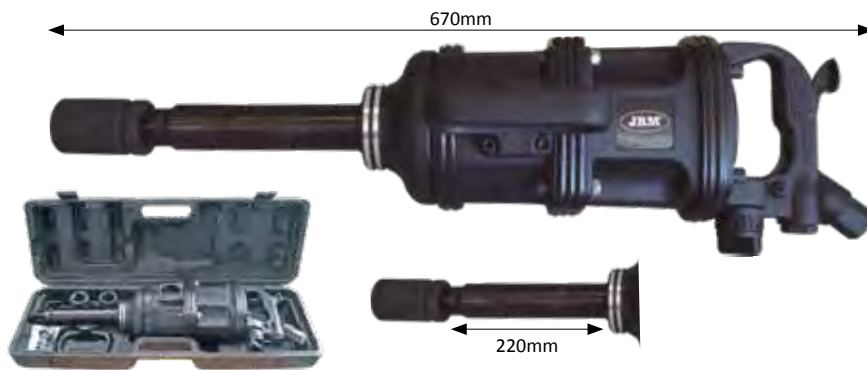

AVVITATORE PNEUMATICO PER CAMION 1"

2203Nm

| | | | |
|----------------|------|---|----|
| 53135 | 7,92 | 2 | 70 |
| 515,00€ | Kg | | |

| | | | |
|----|-----------------------|-------------------------|-----------------------|
| 1" | MAX 2203 Nm | 4.000 RPM 1.901,5 Nm | 4.000 RPM 2.203 Nm |
| | 10 bar | 90 PSI 12 CFM | 1/2" |
| | 96,66 / 107,66 dBA | x6 SPEED | |



TRAPANO AD ANGOLO DI 90° COMPOSITE 3/8"

| | | | |
|----------------|------|----|-----|
| 51221 | 1,27 | 10 | 120 |
| 200,50€ | Kg | | |

COMPOSITE

Reversibile per entrambi i lati.
Finitura in gomma.

| | | |
|------|-----------|---------|
| 3/8" | 1.400 RPM | 1,2kg |
| 1/4" | | 85 dBA |
| 90° | 3/8" | Ø 9,5mm |



MINI SMERIGLIATRICE DA 3/8" 6mm COMPOSITE

| | | | |
|----------------|------|----|-----|
| 51245 | 0,60 | 20 | 240 |
| 105,50€ | Kg | | |

COMPOSITE

| | | |
|-------|------------|--------|
| 3/8" | 25.000 RPM | |
| 0,4kg | 1/4" | 77 dBA |

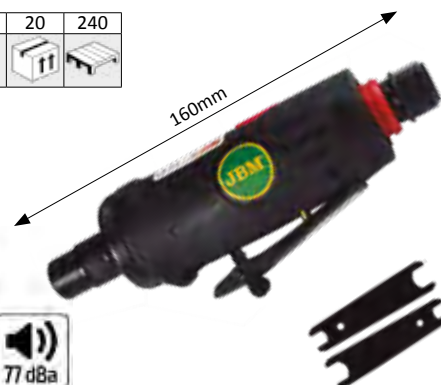

TRAPANO REVERSIBILE COMPOSITE 1/2"

| | | | |
|----------------|------|----|-----|
| 51220 | 1,64 | 10 | 120 |
| 214,50€ | Kg | | |

COMPOSITE

Reversibile per entrambi i lati.

| | | |
|--------|---------|----------|
| 1/2" | 300 RPM | 1,3kg |
| 83 dBA | 0,5 HP | x2 SPEED |
| | | Ø 12,5mm |



KIT CRICCHETTO MULTIFUNZIONE DA 1/4" CON TESTA APERTA / COMPOSITE

40,7Nm

| | | | |
|----------------|------|----|-----|
| 51225 | 0,89 | 10 | 120 |
| 209,00€ | Kg | | |

COMPOSITE

Kit include:
Riduttore da 1/4" a 3/8".
Testa per inserti da 1/4".
Set di 2 inserti a lama + inserti a croce.

| | |
|---------|----------------|
| 1/4" | MAX 40,7 Nm |
| 850 RPM | |
| 0,5kg | 85 dBA |



CRICCHETTO MINI DA 1/4" COMPOSITE

| | | | |
|----------------|------|----|-----|
| 51214 | 0,52 | 20 | 240 |
| 141,00€ | Kg | ft | ft |

COMPOSITE



CRICCHETTO DA 1/2" COMPOSITE

| | | | |
|----------------|------|----|-----|
| 51215 | 1,33 | 20 | 240 |
| 109,00€ | Kg | ft | ft |

COMPOSITE



Rotazione dell'aria di aspirazione e scarico.
Cuscinetto a sfere.
Regolatore dell'aria.

KIT TAGLIAPNEUMATICI CON USCITA POSTERIORE / COMPOSITE

| | | | |
|----------------|------|----|-----|
| 51227 | 2,03 | 10 | 120 |
| 186,50€ | Kg | ft | ft |

COMPOSITE



Finitura in gomma.
Leva reversibile.
Uscita posteriore.



x10 3"

Include occhiali, leva, chiave a brugola e 10 dischi.



RICAMBI NELLA PAGINA 102

KIT LEVIGATRICE ORBITALE DA 2" COMPOSITE

| | | | |
|----------------|------|----|-----|
| 51226 | 1,52 | 10 | 120 |
| 214,50€ | Kg | ft | ft |

COMPOSITE



Finitura in gomma.
Leva reversibile.
Uscita posteriore.



#60, #80, #120



RICAMBI NELLA PAGINA 102

UTENSILE PNEUMATICO PER IL MONTAGGIO DI CUFFIE SEMIASSE

| | | | | |
|----------------|------|----|----|----|
| 51861 | 4,08 | 1 | 2 | 32 |
| 163,00€ | Kg | sb | ft | ft |

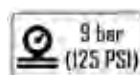

Materiale: Alluminio.
Apertura da 20 a 100mm.



TAGLIATRICE DA 4" COMPOSITE

| | | | |
|----------------|-----|----|-----|
| 51219 | 2,1 | 10 | 120 |
| 214,50€ | Kg | ft | ft |

Finitura in gomma.
Leva di sicurezza in 8 posizioni.



COMPOSITE



SMERIGLIATRICE ORBITALE COMPOSITE 1/4"

| | | | |
|----------------|------|----|-----|
| 51218 | 2,27 | 10 | 120 |
| 262,00€ | Kg | ft | ft |

Finitura in gomma.
Miglior presa in mano.
Leva reversibile.



COMPOSITE

RICAMBI NELLA PAGINA 102

TIRABOLLI A VUOTO D'ASPIRAZIONE

| | | | |
|----------------|------|---|----|
| 52540 | 4,69 | 3 | 72 |
| 176,00€ | Kg | | |

160L / min
70-110Psi

620mm Ø 75 - 100 -125mm



Ventosa con martello pneumatico per rimuovere le ammaccature.
Il suo disegno permette eliminare le ammaccature in modo veloce e semplice.

KIT LUCIDATRICE COMPOSITE

| | | | |
|----------------|------|---|----|
| 51216 | 4,33 | 4 | 16 |
| 572,00€ | Kg | | |

COMPOSITE

IMPUGNATURA ANATOMICA



Protezione dell'utente di detriti / scintille.
Adattatore (brevettato).
Sicurezza nell'acceleratore a leva.
Uscita posteriore.
Allen.
Rumorosità ridotta 83 dBa.
Diversi tipi di ruote.
Spazzola metallica (fine): 11, 23 mm.
Spazzola metallica (spessore): 11, 23 mm.

Cancellatore di gomma.
Cancellatore di vernici a base acqua.
Adattatore da 23 mm per gomma da cancellare e spazzola metallica.
Adattatore per spazzole metalliche da 11 mm.
Lucidatore di gomma nero (fino a 6 pezzi).
Adattatore unico per lucidatrice di gomma.
Doppio adattatore per striscia di gomma.

ACCESSORI

ADATTATORI

27,50€/u.

Per ruota da 23mm

| | | | |
|--------------|------|----|-----|
| 51439 | 0,12 | 50 | 800 |
| | Kg | | |



Per ruota da 11mm

| | | | |
|--------------|-----|---|-----|
| 51440 | 0,1 | 1 | 800 |
| | Kg | | |



Per ruota nera doplo

| | | | |
|--------------|-----|---|-----|
| 51441 | 0,1 | 1 | 800 |
| | Kg | | |



Per ruota nera sem.

| | | | |
|--------------|-----|---|-----|
| 51442 | 0,1 | 1 | 800 |
| | Kg | | |



PENNELLI

20,00€/u.

Spazzola di 23mm

| | | | |
|--------------|------|-----|-----|
| 51388 | 0,08 | 100 | 800 |
| | Kg | | |



Spazzola di 11mm

| | | | |
|--------------|------|---|-----|
| 51389 | 0,05 | 1 | 800 |
| | Kg | | |



Spazzola fine di 23mm

| | | | |
|--------------|-----|---|-----|
| 51390 | 0,1 | 1 | 800 |
| | Kg | | |



Spazzola fine di 11mm

| | | | |
|--------------|------|---|-----|
| 51391 | 0,04 | 1 | 800 |
| | Kg | | |



RUOTE RASOI

27,50€/u.

| | | | |
|--------------|------|---|-----|
| 51392 | 0,10 | 1 | 800 |
| | Kg | | |



51392
Spazzola
Toglivernice
Ø105mm



51393
Spazzola
Toglivernice all'acqua
Ø105mm



51394
Ruota nera



1,2kg

N

AVVITATRICE PER DADI ELETTRICO 1/2"

520Nm

| | | | |
|----------------|------|---|----|
| 53491 | 6,15 | 4 | 32 |
| 603,00€ | Kg | | |



Numero di percussioni:
3200/minuto



x2



BATTERIA
18V 4.0Ah

| | | |
|----------------|------|----|
| 14092 | 0,64 | 10 |
| 147,50€ | Kg | |

AVVITATORE PNEUMATICO DA 1/2" COMPOSITE 1220Nm

52983 1,44 5 330
163,00€ Kg

130mm

COMPOSITE



AVVITATORE PNEUMATICO DA 1/2" COMPOSITE 1492Nm

52767 2,66 10 160
361,00€ Kg

COMPOSITE

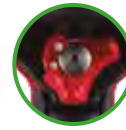

PISTOLA DI IMPATTO 3/4" COMPOSITE 1626Nm

53142 2,29 10 180
314,50€ Kg

3/4" COMPOSITE



AVVITATORE PNEUMATICO DA 3/4" 1600Nm

53343 7,9 2 96
277,00€ Kg



SMERIGLIATRICE PNEUMATICA PER VALVOLE

52689 1,75 10 320
159,00€ Kg

Regolatore di velocità
20, 30, 35, 45mm

VENTOSE DI GOMMA



MINI SMERIGLIATRICE 1/4" COMPOSITE

53137 0,55 20
42,00€ Kg

1/4" COMPOSITE



170mm

AVVITATORE PNEUMATICO 1" 1600Nm

53344 8,05 2
320,00€ Kg



SMERIGLIATRICE PNEUMATICO ANGOLARE DI 1/4" COMPOSITE

| | | |
|---------------|------|----|
| 53141 | 0,55 | 60 |
| 66,50€ | Kg | ff |

1/4" COMPOSITE

| | |
|------------|-----------------|
| 18.000 RPM | 0,4kg |
| 1/4" | 90 PSI 5 CFM |



LEVIGATRICE ANGOLARE PNEUMATICA

| | | | | |
|---------------|------|-----|----|-----|
| 52528 | 0,69 | 5 | 20 | 960 |
| 48,50€ | Kg | sub | ff | |



Corpo in alluminio e rinforzato in gomma.
Facilità di manipolazione e peso leggero.



SEGA PNEUMATICA

| | | | | |
|---------------|------|-----|----|-----|
| 52574 | 0,73 | 4 | 20 | 640 |
| 64,00€ | Kg | sub | ff | |

2 Sega ricambi 95mm de 32 denti.
2 Chiavi allen.
1 protezione.



| | | |
|-----------|-----------------|------|
| 8.000 RPM | 90 PSI 4 CFM | 1/4" |
|-----------|-----------------|------|



11956 5,00€
SET DI 5 LAME A 24 DENTI
PER LEGNO



11957 5,00€
SET DI 5 LAME A 32 DENTI
PER FERRO

STACCAPUNTI PER PUNTI DI SALDATURA CON SCORRIMENTO DELLA PUNTA CENTRALE

| | | | |
|----------------|------|----|----|
| 52724 | 2,55 | 6 | 84 |
| 321,50€ | Kg | ff | |



1.800 Rpm
Adatte per trapani 8 - 6.5mm
De 1/4" / 6.3, 90 (psi)

| | | | |
|----------------|------|----|-----|
| 52725 | 2,35 | 10 | 180 |
| 308,50€ | Kg | ff | |



1.600 Rpm
Adatte per trapani 6.5 - 8.0 - 10mm
De 1/4" / 6.3 (psi)



TRAPANO PER
REF. 52725 Y 52724

| | |
|---------------------|-------|
| 13817 15,50€ | 6,5mm |
| 13818 19,00€ | 8mm |

LEVIGATRICE PNEUMATICA

| | | | |
|----------------|------|----|-----|
| 53136 | 1,13 | 9 | 152 |
| 167,00€ | Kg | ff | |

| | |
|-------------------|---------|
| 11.000 RPM | 1/4" |
| 90 PSI 6,5 CFM | Ø 150mm |



SMERIGLIATRICE PNEUMATICO COMPOSITE

| | | | |
|---------------|------|----|-----|
| 53140 | 0,99 | 14 | 400 |
| 93,50€ | Kg | ff | |

COMPOSITE

| | |
|------------|-----------------|
| 18.000 RPM | 1kg |
| 1/4" | 90 PSI 5 CFM |



RICAMBIO DI DISCO
PER RIF. 53140

| |
|--------------------|
| 14013 0,70€ |
|--------------------|

LEVIGATRICE ORBITALE CON ASPIRAZIONE



200mm

Corpo in alluminio con finitura di gomma.



| | | | | | |
|---------------|------|-----|----|-----|-----|
| 52675 | 1,27 | 5 | 10 | 160 | 5mm |
| 76,50€ | Kg | sub | ff | | |

| | | | | | |
|---------------|------|-----|----|-----|-------|
| 52758 | 1,33 | 5 | 10 | 160 | 2,5mm |
| 76,50€ | Kg | sub | ff | | |



LEVIGATRICE ORBITALE AUTO-ASPIRANTE

| | | | | |
|---------------|-----|-----|----|-----|
| 52676 | 1,5 | 5 | 10 | 120 |
| 84,50€ | Kg | sub | ff | |

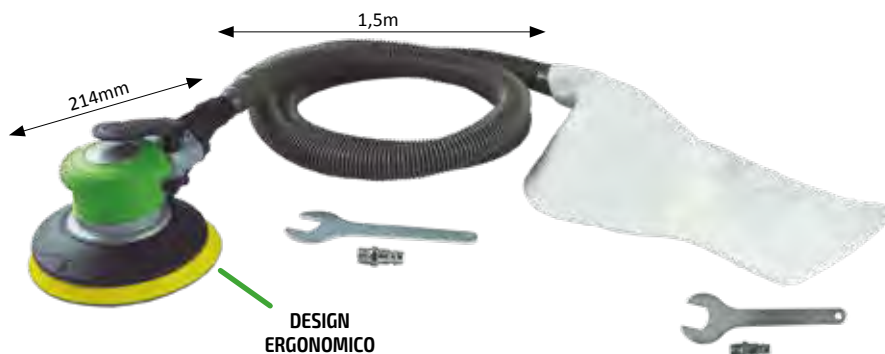

Corpo in alluminio con finitura di gomma.
Eccellente rendimento di pulizia con borsa e tubo.

KIT PISTOLA + CRIC PNEUMATICO + ACC 68 PEZZI

PISTOLA PNEUMATICA + MARTELLO PNEUMATICO + CRICCHETTO PNEUMATICO + MINI LUCIDATRICE + PISTOLA ARIA + PISTOLA ARIA DRITTA + ACCESSORI

| | | | |
|----------------|------|----|----|
| 52331 | 7,79 | 2 | 48 |
| 202,00€ | Kg | ff | |

- 1 x Pistola impatto 1/2"
- 1 x Pneumatico martello 150mm
- 1 x Cricchetto pneumatico 3/8"
- 1 x Lucidatrice pneumatica
- 1 x Fermo molla
- 1 x Barra di prolunga 1/2" - 75mm
- 1 x Mini di 1x-75mm oliatore
- 1 x Chiave esagonale 4mm
- 8 x Impatto vasi: 12, 13, 17, 19, 1/2", 9/16", 5/8", 11/16"
- 1 x Pistola soffiaggio

- 1 x Pistola mini di soffiaggio
- 1 x nastro teflon
- 4 x 120mm
- 2 x Chiavi dinamometriche scarpate manuali
- 5 x disco di levigatura 1/4"
- 5 x Disco di levigatura 1/2"
- 5 x Pietre rettifica 1/4"
- 5 x Pietra lucidatura 3/8"
- 2 x levigatura cilindri (3/4" e 1")
- 1 x Adattatore rapido femmina

- 1 x Connettore di scarpata
- 8 x perni di collari soffiati
- 2 x Collari 1/8"
- 1 x Connettore rapido M-M
- 1 x Connettore rapido M-H
- 1 x Guarnizione di gomma
- 1 x Guarnizione ogiva
- 1 x Ago di inflazione
- 1 x Ugello di sicurezza
- 1 x Ugello ad alta pressione
- 1 x Scatola di plastica



VALIGETTA DA 16 PEZZI PNEUMATICI CON CRICCHETTO 61Nm E AVVITATORE 312Nm

| | | | | | |
|----------------|------|----|-----|------|--------|
| 52156 | 5,36 | 4 | 112 | 1/2" | 16 PCS |
| 120,50€ | Kg | ff | | | |

| |
|---|
| 9, 10, 11, 13, 14, 17, 19, 22, 24, 27mm |
|---|

Avvitatore pneumatico:



Cricchetto:

Adattatore M / H



AVVITATORE PNEUMATICO DA 1/2" **610Nm**

| | | | |
|----------------|------|---|-----|
| 52165 | 2,90 | 6 | 168 |
| 107,00€ | Kg | | |



AVVITATORE PNEUMATICO FARFALLA 3/8" **102Nm**

| | | | | |
|---------------|------|---|----|-----|
| 52168 | 1,02 | 5 | 10 | 400 |
| 40,00€ | Kg | | | |



Uscita: laterale

CRICCHETTO PNEUMATICO DA 1/2" **61Nm**

| | | | |
|---------------|------|----|-----|
| 52167 | 1,27 | 10 | 700 |
| 41,50€ | Kg | | |



MARTELLLO PNEUMATICO

| | | | |
|---------------|------|---|-----|
| 52718 | 2,11 | 8 | 160 |
| 37,50€ | Kg | | |

9
PCS



TRAPANO REVERSIBILE PNEUMATICO DA 1/2"

| | | | | |
|---------------|------|---|----|-----|
| 52159 | 1,79 | 5 | 10 | 240 |
| 53,00€ | Kg | | | |



TRAPANO REVERSIBILE PNEUMATICO DA 3/8" AD ANGOLO DI 90°

| | | | | |
|---------------|------|---|----|-----|
| 52527 | 1,22 | 5 | 10 | 480 |
| 65,50€ | Kg | | | |



TRAPANO REVERSIBILE PNEUMATICO DA 3/8"

| | | | | |
|---------------|------|---|----|-----|
| 52160 | 1,22 | 5 | 10 | 360 |
| 42,00€ | Kg | | | |



KIT DA 16 PEZZI CON SMERIGLIATRICE PNEUMATICA

| | | | | |
|---------------|----|---|----|-----|
| 52157 | 1 | 5 | 10 | 300 |
| 37,50€ | Kg | | | |



SMERIGLIATRICE ORBITALE PNEUMATICA 1/4"

| | | | | |
|---------------|-----|---|----|-----|
| 52166 | 2,8 | 5 | 10 | 200 |
| 70,00€ | Kg | | | |



DISCO PER LUCIDARE 4" PER 52166

| | |
|--------------|--------------|
| 12962 | 3,00€ |
|--------------|--------------|

MINI SMERIGLIATRICE PNEUMATICA 1/4"

| | | | | |
|---------------|------|----|----|-------|
| 52171 | 0,42 | 10 | 20 | 1.080 |
| 29,00€ | Kg | | | |

1/4"

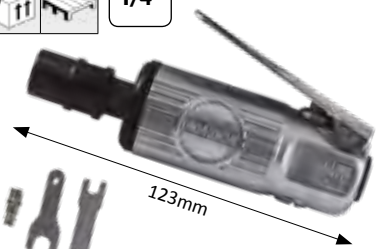

TAGLIATRICE PNEUMATICA DA 3"

| | | | | |
|---------------|-----|-----|----|-------|
| 52953 | 0,9 | 5 | 20 | 1.500 |
| 29,00€ | Kg | sub | ff | |

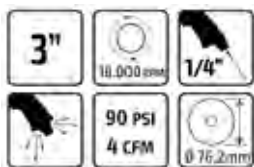

DISCO DA TAGLIO 3"
PER REF. 52953

12987 1,50€

PLATORELLI DI TAGLIO

PER REF. 51227

| | | | | |
|--------------|------|-----|-----|-----|
| 51387 | 0,02 | 50 | 100 | 800 |
| 3,00€ | Kg | sub | ff | |



3" Ø Interior: 9,53mm
Ø Esterno: 75mm

PER REF. 51219

| | | | |
|--------------|------|----|-----|
| 51385 | 0,07 | 25 | 800 |
| 4,50€ | Kg | ff | |



4"x1/32" Ø Interior: 9,53mm
Ø Esterno: 100mm

PLATORELLI ABRASIVI

PER REF. 51218

| | | | |
|--------------|-----|----|-----|
| 51386 | 0,1 | 25 | 800 |
| 6,00€ | Kg | ff | |



5" Ø Interior: 22mm
Ø Esterno: 125mm

PER REF. 51226

| | | | |
|--------------|------|----|-----|
| 51443 | 0,02 | 25 | 800 |
| 5,50€ | Kg | ff | |



#60 Ø Esterno: 2"

PER REF. 51226

| | | | |
|--------------|------|----|-----|
| 51444 | 0,02 | 25 | 800 |
| 5,50€ | Kg | ff | |



#80 Ø Esterno: 2"

PER REF. 51226

| | | | |
|--------------|------|----|-----|
| 51445 | 0,02 | 25 | 800 |
| 5,50€ | Kg | ff | |



#120 Ø Esterno: 2"

ESPOSITORI DI UTENSILI PNEUMATICI

N

| | | | |
|----------------|----|----|---|
| 53492 | 13 | 1 | 7 |
| 291,50€ | Kg | ff | |

CONSEGNA
SENZA UTENSILE



GANCIO MAGNETICO

| | | | | |
|--------------|------|-----|----|-----|
| 52378 | 0,36 | 10 | 40 | 720 |
| 9,00€ | Kg | sub | ff | |

3 Kg 6cm



| | | | |
|---------------|------|----|----|
| 51341 | 1,62 | 12 | 96 |
| 33,00€ | Kg | ff | |

23 Kg 6cm



ESPOSITORI DI UTENSILI PNEUMATICI

53147

30,00€

| | |
|-----|------|
| Kg | 1,15 |
| sub | 5 |
| ff | 10 |
| | 200 |

CONSEGNA
SENZA UTENSILE



POMPA PNEUMATICA

MANOMETRO ANALOGICO

| | | | | |
|---------------|-----|-----|----|-----|
| 53449 | 0,4 | 5 | 20 | 320 |
| 18,00€ | Kg | sub | ff | |

0-7 BAR
0-100 PSI

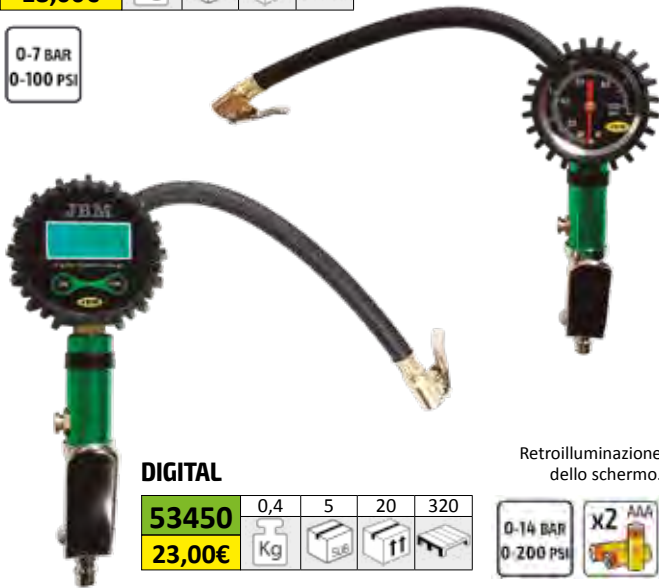

DIGITAL

| | | | | |
|---------------|-----|-----|----|-----|
| 53450 | 0,4 | 5 | 20 | 320 |
| 23,00€ | Kg | sub | ff | |

Retroilluminazione dello schermo.



SET PULIZIA FILTRO ANTIPARTICOLATO

| | | | |
|----------------|------|----|----|
| 52543 | 0,84 | 6 | 96 |
| 142,00€ | Kg | ff | |

Universale
Capacità massima: 650cc
Tubo flessibile in nylon
4x6x2.7m
Portata: 3 bar - 7 bar
Corpo inossidabile, alta resistenza + base in alluminio



LIQUIDO DECARBONIZZANTE

| | | | | |
|---------------|------|-----|----|-----|
| 90003 | 1,08 | 3 | 12 | 400 |
| 39,00€ | Kg | sub | ff | |

LIQUIDO NEUTRALIZZANTE

| | | | | |
|---------------|-----|-----|----|-----|
| 90004 | 0,5 | 3 | 20 | 320 |
| 28,50€ | Kg | sub | ff | |

SERIE75: SET COMPOSTO DA 52543+90003+90004 **201,50€**

PISTOLA SOFFIAGGIO ARIA + PISTOLA GONFIAPNEUMATICI

51981
20,00€

| | |
|-----|------|
| Kg | 0,58 |
| sub | 5 |
| ff | 20 |
| | 240 |



0-16 BAR
0-220 PSI

1/4"



PISTOLA GONFIAPNEUMATICI

51980
14,00€

| | | | | |
|-----|------|---|----|-----|
| Kg | 0,38 | 5 | 25 | 300 |
| sub | | | | |
| ff | | | | |
| | | | | |

0-16 BAR
0-220 PSI



TESTER DI PRESSIONE PNEUMATICI

52648
7,00€

| | | | |
|-----|-----|---|-----|
| Kg | 0,1 | 5 | 100 |
| sub | | | |
| ff | | | |



CON TUBO

53416
13,00€

| | | | |
|-----|-----|----|-----|
| Kg | 0,2 | 10 | 100 |
| sub | | | |
| ff | | | |



DIGITALE CON TUBO

53417
21,50€

| | | | |
|-----|-----|----|-----|
| Kg | 0,3 | 10 | 100 |
| sub | | | |
| ff | | | |



DIGITALE

53418
11,50€

| | | | | |
|-----|-----|----|-----|-----|
| Kg | 0,2 | 10 | 100 | 800 |
| sub | | | | |
| ff | | | | |



PISTOLA AEROGRAFA

| | | | |
|---------------|------|----|-----|
| 52529 | 0,43 | 20 | 480 |
| 29,00€ | | | |

Pistola con regolatore di pressione/colore.
 Contenitore da 15ml.
 Cavo da 160mm.
 Adattatore.
 Connettore 1/4" .
 Entrata d'aria 1/4.



PISTOLA PER ARIA COMPRESSA

| | | | | | |
|--------------|------|----|----|-----|--|
| 52490 | 0,12 | 10 | 40 | 960 | |
| 5,50€ | | | | | |

| | | | | | |
|--------------|-----|----|----|-----|--|
| 52491 | 0,1 | 10 | 80 | 400 | |
| 8,50€ | | | | | |



Acquistabile singolarmente o in espositore da 10 unità

PISTOLA AD ARIA COMPRESSA

| | | | | | |
|---------------|------|----|----|-----|--|
| 52798 | 0,25 | 10 | 50 | 700 | |
| 14,50€ | | | | | |



PISTOLA DI SOFFIAGGIO

| | |
|---------------|-----|
| 53205 | 0,9 |
| 16,50€ | |

| | |
|--|-----|
| | 0,9 |
| | 48 |
| | 500 |



SET DI 5 UTENSILI AD ARIA

| | |
|---------------|------|
| 51277 | 1,84 |
| 43,00€ | |
| | 1,84 |
| | 5 |
| | 40 |



Pistola per verniciare per gravità con serbatoio di 600 ml.
 Gonfia pneumatici con manometro.
 Pistola soffiaggio aria.

Pistola nebulizzatrice con serbatoio per soluzione di pulizia.
 Tubo a spirale di 5x8 mm ad attacco rapido 1/4" allungabile sino a 4,5 m.

PISTOLA DI SOFFIAGGIO IN BLISTER

| | | | | |
|--------------|------|----|----|-----|
| 51383 | 0,27 | 10 | 50 | 650 |
| 9,50€ | | | | |

Pistola soffiaggio aria.
 Attacco rapido europeo.
 Attacco per tubo.
 Prolunga del tubo di 10cm.
 Prolunga del tubo di 20cm.



Acquistabile singolarmente o in espositore da 10 unità

PISTOLA AD ARIA COMPRESSA + TUBO SPIRALATO DA 3/8" DA 5m

| | |
|---------------|------|
| 52381 | 0,45 |
| 17,50€ | |

| | |
|--|------|
| | 0,45 |
| | 5 |
| | 25 |
| | 200 |

Material: PU // 35 colpi di scena



PISTOLA DI SOFFIAGGIO IN BLISTER INDIVIDUALE

| | | | | |
|--------------|-----|----|-----|-------|
| 52787 | 0,2 | 25 | 100 | 1.000 |
| 7,00€ | | | | |



PISTOLA PER LAVAGGIO MOTORI

| | | | |
|---------------|-----|----|-----|
| 53202 | 1,4 | 10 | 120 |
| 17,50€ | Kg | ft | ft |



Pistola per lavaggio motori.
Materiale: Acciaio.
Materiale corpo: lega di alluminio.
Superficie: verniciatura a polvere.



PISTOLA DI PULIZIA AD ARIA

| | | | |
|---------------|-----|----|----|
| 53204 | 0,9 | 10 | 60 |
| 62,00€ | Kg | ft | ft |



Pistola di pulizia ad aria, nera.
Materiale: PE.
Materiale corpo: lega di alluminio.
Superficie corporea: Lucido.

FILTRO DELL'OLIO CON REGOLATORE

| | | | | |
|---------------|------|-----|----|------|
| 53063 | 0,63 | 5 | 50 | 1/4" |
| 32,00€ | Kg | sub | ft | |

| | | | | |
|---------------|------|-----|----|------|
| 53064 | 0,63 | 5 | 50 | 3/8" |
| 32,00€ | Kg | sub | ft | |

| | | | | |
|---------------|------|-----|----|------|
| 53065 | 0,63 | 5 | 50 | 1/2" |
| 32,00€ | Kg | sub | ft | |



FILTRO DELL'OLIO CON REGOLATORE

| | | | | | |
|---------------|------|-----|----|-----|------|
| 53066 | 1,08 | 5 | 25 | 250 | 1/4" |
| 53,00€ | Kg | sub | ft | ft | |

| | | | | | |
|---------------|------|-----|----|-----|------|
| 53067 | 1,07 | 5 | 25 | 250 | 3/8" |
| 53,00€ | Kg | sub | ft | ft | |

| | | | | | |
|---------------|------|-----|----|-----|------|
| 53068 | 1,06 | 5 | 25 | 250 | 1/2" |
| 53,00€ | Kg | sub | ft | ft | |



ADATTATORE ARTICOLATO NEUMATICO

| REF. | | Kg | ft | ft | € |
|-------|------|------|----|-----|--------|
| 12988 | 1/2" | 0,15 | 62 | 125 | 8,00€ |
| 13809 | 1/4" | 0,10 | 62 | 250 | 10,00€ |
| 13810 | 3/8" | 0,10 | 62 | 250 | 11,50€ |



ATTACCO RAPIDO PNEUMATICO

| | | | | |
|--------------|----|------|----|-----|
| 52735 | M6 | 0,07 | 25 | 200 |
| 5,00€ | Kg | | | |
| | ft | | | |
| | ft | | | |

| | | | | |
|--------------|----|------|----|-----|
| 52736 | M8 | 0,07 | 25 | 200 |
| 5,00€ | Kg | | | |
| | ft | | | |
| | ft | | | |

| | | | | |
|--------------|-----|------|----|-----|
| 52737 | M10 | 0,08 | 25 | 200 |
| 5,00€ | Kg | | | |
| | ft | | | |
| | ft | | | |

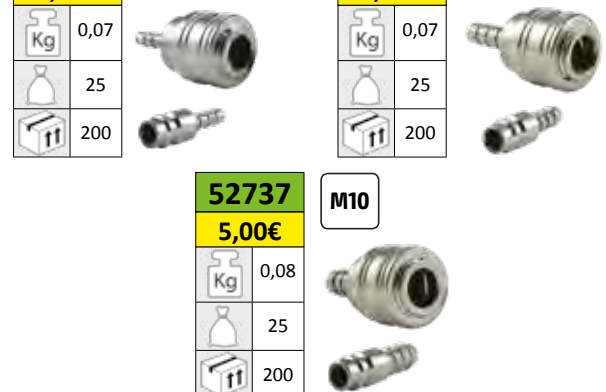

RACCORDO RAPIDO / FILETTO

| REF. | DESCRIZIONE | pz. | Kg | €/u. |
|-------------|---|-----|------|-------|
| USA | | | | |
| 13930 | RACCORDO RAPIDO MASCHIO - FILETTO MASCHIO DA 1/4" | 1 | 0,05 | 1,50€ |
| 13932 | RACCORDO RAPIDO MASCHIO - FILETTO MASCHIO DA 3/8" | 1 | 0,1 | 1,50€ |
| 14076 | RACCORDO RAPIDO MASCHIO - FILETTO FEMMINA DA 3/8" | 1 | - | 1,00€ |
| 13933 | RACCORDO RAPIDO MASCHIO - FILETTO MASCHIO DA 1/2" | 1 | 0,1 | 1,50€ |
| 13935 | RACCORDO RAPIDO MASCHIO - FILETTO FEMMINA DA 1/4" | 2 | 0,05 | 2,00€ |
| 13936 | RACCORDO RAPIDO FEMMINA - FILETTO FEMMINA DA 1/4" | 1 | 0,05 | 3,50€ |
| 13937 | RACCORDO RAPIDO FEMMINA - FILETTO MASCHIO DA 1/4" | 1 | 0,05 | 4,00€ |
| 14078 | RACCORDO RAPIDO FEMMINA - FILETTO FEMMINA DA 3/8" | 1 | - | 3,50€ |
| EURO | | | | |
| 13931 | RACCORDO RAPIDO MASCHIO - FILETTO MASCHIO DA 1/4" | 2 | 0,05 | 2,00€ |
| 14075 | RACCORDO RAPIDO MASCHIO - FILETTO FEMMINA DA 3/8" | 1 | - | 1,00€ |
| 13934 | RACCORDO RAPIDO MASCHIO - FILETTO FEMMINA DA 1/4" | 2 | 0,05 | 2,00€ |
| 13938 | RACCORDO RAPIDO FEMMINA - FILETTO FEMMINA DA 1/4" | 1 | 0,1 | 3,50€ |
| 13939 | RACCORDO RAPIDO FEMMINA - FILETTO MASCHIO DA 1/4" | 1 | 0,1 | 4,00€ |
| 14077 | RACCORDO RAPIDO FEMMINA - FILETTO FEMMINA DA 3/8" | 1 | - | 3,50€ |



AVVOLGITUBO DELL'ARIA DA 3/8"

| | | |
|---------------|-----|----|
| 53532 | 6,2 | 2 |
| 97,00€ | Kg | 1f |

3/8" 12 m
20 BAR 300 PSI
Ø9,5 mm



AVVOLGITUBO DELL'ARIA DA 3/8"

| | | | |
|----------------|-----|----|----|
| REF. | 7,1 | 1 | 21 |
| 108,00€ | Kg | 1f | |

Supporto/Avvolgitore.
per tubo dell'aria.
Senza elettricità.
Senza batteria.
PVC.

3/8" 12 m
20 BAR 300 PSI
Ø9,5 mm



51299



52755



CON
RIPARTITORE

Tubo: Ø interno = 9,5 mm / Ø esterno = 12 mm
Filettatura: Ø esterno = 14 mm

Tubo: Ø interno = 9,5 mm / Ø esterno = 12 mm
Filettatura: Ø esterno = 14 mm

AVVOLGITUBO VERDE DELL'ARIA DA 20M

| | | | |
|----------------|------|----|----|
| REF. | 9,05 | 1 | 16 |
| 147,50€ | Kg | 1f | |

Supporto/Avvolgitore.
per tubo dell'aria.
Senza elettricità.
Senza batteria.
PVC.

3/8" 20 m
20 BAR 300 PSI
Ø9,5 mm

53115



53213





BUSSOLE PNEUMATICHE

| | |
|---------------------------|-----|
| SET DI BUSSOLE | 108 |
| BARRE DI ESTENSIONE | 110 |
| SET DI PUNTE | 111 |
| BUSSOLE PNEUMATICHE | 113 |
| MEZZI PESANTI | 114 |



SET DI 3 BUSSOLE PNEUMATICHE DA 1/2" ESAGONALI + 3 INSERTI

| | | | | |
|---------------|------|---|----|-----|
| 52337 | 1,91 | 5 | 10 | 300 |
| 52,50€ | Kg | 5 | 10 | 300 |



30, 32, 36mm
(80mmL)

3 punte Hex: 14,
17, 19 (43mmL)



SET DI 8 BUSSOLE A PUNTA XZN DA 1/2"

| | | | |
|---------------|------|---|-----|
| 52547 | 2,76 | 5 | 200 |
| 75,00€ | Kg | 5 | 200 |

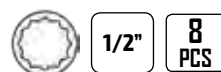

27, 30, 32,
34, 36

M14, M16,
M18 (43mmL)



SET DI 14 BUSSOLE PNEUMATICHE DA 1/2" CON ADATTATORE

19
PCS

| | | | |
|---------------|------|---|-----|
| 52345 | 3,55 | 6 | 234 |
| 86,50€ | Kg | 6 | 234 |



| | | | |
|---------------|------|---|-----|
| 53531 | 3,55 | 4 | 234 |
| 86,50€ | Kg | 4 | 234 |



10, 11, 12, 13, 14, 15, 16, 17, 18,
19, 21, 22, 24, 27mm

1 snodo universale 1/2".
3 prolunghe 50, 150, 250mm.
1 adattatore 1/2" H x 3/4" M.



SET DI 12 BUSSOLE PNEUMATICHE LUNGHE DA 1/2" ESAGONALI

| | | | |
|---------------|------|---|-----|
| 52346 | 4,55 | 6 | 216 |
| 86,50€ | Kg | 6 | 216 |



10, 12, 13, 15, 16, 17, 18, 19,
21, 22, 24, 27mm
(78mmL)

1 snodo universale.
2 prolunghe di 125 e 250mm.

➤ **RICAMBI DISPONIBILI**
CONSULTA p.113 REF. 12061 - 12072



SET DI 10 BUSSOLE PNEUMATICHE DA 1/2" ESAGONALI + ADATTATORI

| | | | |
|---------------|------|----|-----|
| 52341 | 1,72 | 12 | 336 |
| 46,50€ | Kg | 12 | 336 |



10, 11, 12, 13, 14,
17, 19, 21, 22, 24mm
(38mmL)

1 snodo universale.
1 prolunga di 125mm.
1 adattatore inserti 1/4".



SET DI 11 BUSSOLE PNEUMATICHE DA 1/2" ESAGONALI

| | | | |
|---------------|------|----|-----|
| 52342 | 2,41 | 10 | 360 |
| 53,00€ | Kg | 10 | 360 |



10, 11, 12, 13,
14, 16, 17,
19, 21, 22,
24mm
(78mmL)

➤ **RICAMBI DISPONIBILI**
CONSULTA p.113 REF. 12061 - 12072



SET DI 12 BUSSOLE PNEUMATICHE DI 1/2" ESAGONALE PROFILO BASSO

| | | | | | | | | | | |
|---------------|------|---|----|-----|--|------|-----------|--|--------|---|
| 53060 | 0,86 | 5 | 25 | 500 | | 1/2" | 12 PCS | | 28.2mm | 10, 11, 12, 13, 14, 15, 16, 17, 18, 19, 20, 21mm |
| 30,50€ | Kg | | | | | | | | | |



SET DI 4 BUSSOLE PNEUMATICHE DA 1/2"

| | | | | |
|---------------|------|---|----|-----|
| 52338 | 1,12 | 5 | 20 | 640 |
| 32,50€ | Kg | | | |



17, 19, 21, 22mm
(85mmL)



| | | | | |
|--------------|------|----|-----|------|
| 11314 | 0,21 | 10 | 100 | 17mm |
| 7,50€ | Kg | | | |

| | | | | |
|--------------|------|----|-----|------|
| 11316 | 0,26 | 10 | 100 | 21mm |
| 8,00€ | Kg | | | |

| | | | | |
|--------------|------|----|-----|------|
| 11315 | 0,23 | 10 | 100 | 19mm |
| 7,50€ | Kg | | | |

| | | | | |
|--------------|------|----|-----|------|
| 11628 | 0,27 | 10 | 100 | 22mm |
| 8,00€ | Kg | | | |

SET DI 3 BUSSOLE PNEUMATICHE DA 1/2"

| | | | | | |
|---------------|------|---|-----|--|------|
| 51336 | 0,82 | 5 | 700 | | 1/2" |
| 27,00€ | Kg | | | | |

3
PCS

17, 19, 21mm
(85mmL)



SET DI 12 BUSSOLE PNEUMATICHE DA 1/2"

| | | | | | |
|---------------|------|---|-----|--|------|
| 52343 | 1,89 | 4 | 288 | | 1/2" |
| 45,50€ | Kg | | | | |

12
PCS

17, 19, 21mm
(85mmL)

10, 11, 13,
14, 17, 19, 22,
24mm (38mmL),
27mm (42mmL)



SET 3 BUSSOLE PNEUMATICHE LUNGHE

| | | | |
|---------------|-----|----|-------|
| 52969 | 0,8 | 20 | 1.500 |
| 17,00€ | Kg | | |



17, 19, 21mm
(78mmL)



| REF. | DESCRIZIONE | Kg | | | € |
|-------|-------------|------|----|----|-------|
| 12066 | 17mm | 0,18 | 10 | 90 | 6,50€ |
| 12068 | 19mm | 0,21 | 10 | 60 | 7,00€ |
| 12069 | 21mm | 0,20 | 10 | 50 | 7,00€ |

BUSSOLE PNEUMATICHE 17mm PER MERCEDES BENZ

| | | | | | | |
|---------------|------|----|-----|------|--|----------|
| 52800 | 0,24 | 10 | 100 | 1/2" | | 1 PCS |
| 13,50€ | Kg | | | | | |

Bussole speciali per bulloni ruota in veicoli di Mercedes Benz.

Valido per questi modelli:

Classe E - W211, W212, W207

Classe S - W221, W222

Classe SLK - W172

Classe C y GLK - W204

Classe ML - W164, W166

Classe CL - W216

17mm



SET DI 3 BUSSOLE XZN DA 1/2"

| | | | | |
|---------------|------|-----|----|-----|
| 52694 | 1,31 | 5 | 10 | 600 |
| 38,50€ | Kg | 5x6 | ff | |



1/2"

**3
PCS**

30, 32, 36mm
(80mmL)



SET DI 4 BUSSOLE DI IMPATTO PER VITTI DI SICUREZZA

| | | | |
|---------------|------|-----|----|
| 53197 | 1,17 | 5 | 20 |
| 41,00€ | Kg | 5x6 | ff |



1/2"

**4
PCS**

17, 19, 21, 22mm
(82mmL)



SET 8 BUSSOLE PNEUMATICHE ESAGONALI CON DOPPIA POSIZIONE (FISSO/ARTICOLATO)

| | | | |
|----------------|------|----|-------|
| 53044 | 2,43 | 8 | 1.000 |
| 108,00€ | Kg | ff | |



1/2"

**8
PCS**

13, 14, 15, 16, 17,
19, 21, 22mm



SET BARRE DI ESTENSIONE PNEUMATICHE

| | | | |
|---------------|------|----|-----|
| 53077 | 1,58 | 10 | 240 |
| 62,00€ | Kg | ff | |

1/2"

CR-MO

**5
PCS**

100Nm
110Nm
120Nm
135Nm
150Nm



13680 13,50€
BARRA DI ESTENSIONE
200NM



13681 13,50€
BARRA DI ESTENSIONE
190NM



13682 13,50€
BARRA DI ESTENSIONE
175NM



13683 13,50€
BARRA DI ESTENSIONE
160NM



13684 14,00€
BARRA DI ESTENSIONE
150NM



13685 14,00€
BARRA DI ESTENSIONE
135NM



13686 14,00€
BARRA DI ESTENSIONE
120NM



13687 15,00€
BARRA DI ESTENSIONE
110NM



13688 15,00€
BARRA DI ESTENSIONE
100NM



13689 15,00€
BARRA DI ESTENSIONE
90NM



BARRE DI ESTENSIONE PNEUMATICHE

| | | | | |
|--------------|------|-----|-----|-------|
| 12937 | 0,11 | 10 | 100 | 1.500 |
| 6,50€ | Kg | 5x6 | ff | |

1/2"

50mm



12937

| | | | |
|--------------|------|-----|----|
| 12074 | 0,23 | 10 | 60 |
| 7,50€ | Kg | 5x6 | ff |

1/2"

125mm



12074

| | | | |
|---------------|------|-----|----|
| 12075 | 0,43 | 10 | 50 |
| 11,00€ | Kg | 5x6 | ff |

1/2"

250mm



12075

SET 3 BUSSOLE PNEUMATICHE CON DOPPIA POSIZIONE (FISSO/ARTICOLATO)

| | | | | | | | | |
|---------------|------|---|----|-------|--|--|--|--|
| 53043 | 0,43 | 5 | 50 | 1.000 | | | | |
| 35,50€ | Kg | | | | | | | |



SET DI 6 BUSSOLE A PUNTA XZN DA 1/2"

| | | | | | |
|---------------|------|----|-----|--|--|
| 52546 | 0,81 | 30 | 720 | | |
| 32,00€ | Kg | | | | |

**6
PCS**

M14, M16, M18 (43mmL)
M14, M16, M18 (78mmL)



SET DI 13 BUSSOLE PNEUMATICHE DA 1/2" ESAGONALI E TORX

| | | | |
|----------------|------|---|-----|
| 52344 | 1,89 | 4 | 288 |
| 163,00€ | Kg | | |

1/2" **13
PCS**

| | | |
|--|-----|---------|
| | 5mm | 10mm |
| | 6mm | 12mm |
| | 8mm | (45mmL) |

| | |
|--|--|
| | T30, T40, T45, T50, T55, T60, T70, T80 (45mmL) |
|--|--|



BUSSOLA PUNTA XZN INVIOLEBILE

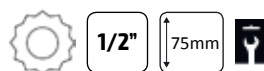

1/2"

75mm



| | | | |
|---------------|------|-----|-----|
| 52810 | 0,17 | 100 | M16 |
| 10,50€ | Kg | | |

Bussole 75 mm lunghe e quadrate di 1/2" per l'estrazione dell'avviatore per trasmissioni di veicoli VAG, Porsche, Ford...



| | | | |
|---------------|------|-----|-----|
| 52811 | 0,17 | 100 | M18 |
| 10,50€ | Kg | | |

Per estrarre il braccio di sterzo del veicolo di gruppo VAG.

SET DI 8 PUNTE LUNGHE PNEUMATICHE ESAGONALI DA 1/2"

| | | | | | | | | |
|---------------|------|---|----|-----|--|--|------------------|--|
| 52339 | 1,27 | 5 | 10 | 480 | | | 8 PCS | 5, 6, 7, 8, 10, 12, 14, 17mm (78mmL) |
| 53,00€ | Kg | | | | | | | |

| REF. | DESCRIZIONE | | | | € |
|-------|-------------|------|----|--|-------|
| 14004 | 5mm | 0,10 | 10 | | 8,50€ |
| 14005 | 6mm | 0,10 | 10 | | 8,50€ |
| 14006 | 7mm | 0,10 | 10 | | 8,50€ |
| 14007 | 8mm | 0,20 | 10 | | 8,50€ |
| 14008 | 10mm | 0,10 | 10 | | 8,50€ |
| 14009 | 12mm | 0,10 | 10 | | 8,50€ |
| 14010 | 14mm | 0,10 | 10 | | 9,00€ |
| 14011 | 17mm | 0,20 | 10 | | 9,50€ |



SET DI 8 PUNTE LUNGHE PNEUMATICHE DA 1/2" TORX

| | | | | | | | |
|---------------|------|----|-----|--|--|------------------|--|
| 52340 | 1,16 | 10 | 300 | | | 8 PCS | T25, T30, T40, T45, T50, T55, T60, T70 (78mmL) |
| 53,00€ | Kg | | | | | | |

| REF. | DESCRIZIONE | | | | € |
|-------|-------------|------|----|--|-------|
| 12939 | T30 | 0,09 | 10 | | 6,50€ |
| 12940 | T40 | 0,09 | 10 | | 6,50€ |
| 12941 | T45 | 0,09 | 10 | | 6,50€ |
| 12942 | T50 | 0,09 | 10 | | 6,50€ |
| 12943 | T55 | 0,1 | 10 | | 6,50€ |
| 12944 | T60 | 0,12 | 10 | | 7,00€ |
| 12945 | T70 | 0,14 | 10 | | 7,00€ |



SET DI 8 BUSSOLE ESAGONALI LUNGHE 3/4"



| | | | |
|----------------|-----|----|----|
| 53470 | 7,5 | 1 | 85 |
| 143,00€ | Kg | ft | ft |

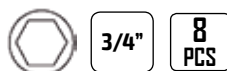

3/4"

8
PCS



24, 27, 29, 30, 32, 34, 36, 38mm (90mmL)



ARTICOLAZIONI UNIVERSALE PNEUMATICHE

| | | |
|---------------|-----|----|
| 11938 | 0,6 | 60 |
| 43,00€ | Kg | ft |

3/4"

| | | |
|---------------|------|-----|
| 11990 | 0,16 | 100 |
| 15,50€ | Kg | ft |

1/2"



11983

11990

SET DI 2 ADATTATORI PNEUMATICI

| | | | |
|----------------|------|----|----|
| 52545 | 1,97 | 2 | 4 |
| 152,00€ | Kg | ft | ft |

1" 1/2" F - 1" M
1" F - 1" 1/2" M



SET DI 16 BUSSOLE PNEUMATICHE 3/4"

| | | | |
|----------------|------|----|-----|
| 51028 | 6,26 | 3 | 380 |
| 211,50€ | Kg | ft | ft |

3/4"

16
PCS

Adattatore da 1".
Adattatore da 3/4".
Allen 4mm.

| | |
|--|---------|
| | H17 H22 |
| | H19 H24 |

| | |
|--|---------|
| | E18 E22 |
| | E20 E24 |

| | |
|--|----------|
| | T60 T90 |
| | T70 T100 |
| | T80 |



SET DI 6 ADATTATORI PNEUMATICI

| | | | |
|---------------|------|----|-----|
| 52544 | 2,89 | 4 | 420 |
| 75,00€ | Kg | ft | ft |

1"

3/4"

1/2"

6
PCS

1/2": F x 1" M (50mmL), F x 3/4" M (48mmL)
3/4": F x 1" M (63mmL), F x 1/2" M (85mmL)
1": F x 3/4" M (69mmL), F x 1/2" M (70mmL)



| REF. | DESCRIZIONE | Kg | ft | ft | € |
|-------|---------------|------|----|-----|--------|
| 11962 | 1/2" H 3/4" M | 0,16 | 10 | 100 | 7,00€ |
| 11963 | 1/2" H 1" M | 0,26 | 6 | 48 | 8,00€ |
| 11964 | 3/4" H 1/2" M | 0,34 | 6 | 36 | 10,00€ |
| 11965 | 3/4" H 1" M | 0,44 | 4 | 28 | 13,50€ |
| 11966 | 1" H 1/2" M | 0,53 | 6 | 36 | 15,50€ |
| 11967 | 1" H 3/4" M | 0,53 | 6 | 24 | 15,50€ |

SET DI 8 BUSSOLE PNEUMATICHE DA 3/4" ESAGONALI

| | | | |
|----------------|------|----|-----|
| 52347 | 6,53 | 4 | 200 |
| 125,50€ | Kg | ft | ft |



3/4"

8
PCS

26, 27, 29, 30, 32, 35, 36, 38mm (90mmL)



SET DI 8 BUSSOLE PNEUMATICHE DA 1"

| | | | |
|----------------|------|----|-----|
| 52348 | 6,08 | 2 | 252 |
| 158,50€ | Kg | ft | ft |



1"

8
PCS

24, 27, 30, 32, 33, 36, 38, 41mm



| REF. | DESCRIZIONE | Kg | ft | ft | € |
|-------|-------------|-----|----|----|--------|
| 13874 | 27mm | 0,6 | 6 | 96 | 13,00€ |
| 13875 | 30mm | 0,5 | 6 | 96 | 14,00€ |
| 13876 | 32mm | 0,6 | 6 | 96 | 14,00€ |
| 13877 | 33mm | 0,6 | 6 | 96 | 14,00€ |



BUSSOLE PNEUMATICHE



| 1" | | | |
|-------|-------|------|---------|
| 11153 | 36mm | 0,71 | 15,50€ |
| 11154 | 37mm | 0,73 | 16,50€ |
| 11155 | 38mm | 0,74 | 16,50€ |
| 11156 | 39mm | 0,74 | 19,00€ |
| 11157 | 40mm | 0,78 | 19,00€ |
| 11158 | 41mm | 0,81 | 19,50€ |
| 11159 | 42mm | 0,91 | 20,50€ |
| 11160 | 43mm | 0,94 | 21,00€ |
| 11161 | 44mm | 0,93 | 21,00€ |
| 11162 | 45mm | 0,94 | 21,50€ |
| 11163 | 46mm | 1,00 | 21,50€ |
| 11164 | 47mm | 1,02 | 22,50€ |
| 11165 | 48mm | 1,01 | 23,00€ |
| 11166 | 50mm | 1,18 | 24,50€ |
| 11167 | 51mm | 1,18 | 28,50€ |
| 11168 | 52mm | 1,18 | 29,00€ |
| 11169 | 53mm | 1,27 | 29,50€ |
| 11170 | 54mm | 1,33 | 30,00€ |
| 11171 | 55mm | 1,44 | 33,50€ |
| 11172 | 56mm | 1,47 | 35,00€ |
| 11173 | 57mm | 1,44 | 35,50€ |
| 11174 | 58mm | 1,58 | 36,00€ |
| 11175 | 59mm | 1,58 | 36,50€ |
| 11176 | 60mm | 1,62 | 38,50€ |
| 11177 | 62mm | 1,63 | 41,50€ |
| 11178 | 63mm | 1,75 | 42,00€ |
| 11179 | 65mm | 1,87 | 46,00€ |
| 11180 | 67mm | 1,93 | 49,00€ |
| 11181 | 68mm | 1,93 | 49,50€ |
| 11182 | 70mm | 2,09 | 53,00€ |
| 11183 | 71mm | 3,10 | 55,00€ |
| 11184 | 73mm | 3,27 | 66,00€ |
| 11185 | 75mm | 3,34 | 68,50€ |
| 11186 | 76mm | 3,70 | 69,50€ |
| 11187 | 78mm | 3,47 | 75,50€ |
| 11188 | 80mm | 3,69 | 76,50€ |
| 11189 | 85mm | 3,81 | 87,50€ |
| 11190 | 89mm | 3,80 | 106,50€ |
| 11191 | 90mm | 4,29 | 106,50€ |
| 11192 | 92mm | 4,50 | 117,00€ |
| 11193 | 95mm | 4,89 | 125,50€ |
| 11194 | 100mm | 4,36 | 136,00€ |
| 11621 | 105mm | 7,81 | 244,50€ |

| | | | |
|-------|-------|------|---------|
| 11622 | 110mm | 7,75 | 308,00€ |
| 11623 | 115mm | 8,21 | 333,50€ |

| 1/2" | | | |
|-------|------|------|-------|
| 11195 | 17mm | 0,09 | 2,50€ |
| 11121 | 19mm | 0,10 | 3,00€ |
| 11122 | 24mm | 0,14 | 3,50€ |
| 11123 | 27mm | 0,17 | 4,00€ |
| 11124 | 30mm | 0,20 | 5,00€ |
| 11125 | 32mm | 0,22 | 5,50€ |

| 3/4" | | | |
|-------|------|------|--------|
| 11126 | 19mm | 0,25 | 7,50€ |
| 11127 | 21mm | 0,29 | 8,50€ |
| 11128 | 22mm | 0,34 | 9,00€ |
| 11129 | 24mm | 0,32 | 9,50€ |
| 11130 | 25mm | 0,33 | 9,50€ |
| 11131 | 26mm | 0,32 | 9,50€ |
| 11132 | 27mm | 0,35 | 9,50€ |
| 11133 | 28mm | 0,40 | 10,00€ |
| 11134 | 30mm | 0,41 | 10,50€ |
| 11135 | 32mm | 0,44 | 11,00€ |
| 11136 | 33mm | 0,47 | 11,00€ |
| 11137 | 34mm | 0,51 | 12,50€ |
| 11138 | 35mm | 0,49 | 12,50€ |
| 11139 | 36mm | 0,52 | 12,50€ |
| 11140 | 38mm | 0,53 | 13,00€ |
| 11141 | 40mm | 0,54 | 14,00€ |
| 11142 | 41mm | 0,61 | 14,50€ |
| 11143 | 46mm | 0,74 | 17,50€ |
| 11144 | 50mm | 1,00 | 22,00€ |
| 11145 | 51mm | 1,10 | 23,50€ |
| 11146 | 55mm | 1,23 | 26,00€ |
| 11147 | 57mm | 1,23 | 29,50€ |
| 11148 | 60mm | 1,40 | 31,50€ |
| 11149 | 63mm | 1,32 | 35,00€ |
| 11150 | 65mm | 1,50 | 37,50€ |
| 11151 | 67mm | 1,49 | 44,50€ |
| 11152 | 70mm | 1,49 | 48,50€ |

| 1" | | | |
|-------|-------|------|---------|
| 11624 | 65mm | 2,42 | 132,00€ |
| 11625 | 85mm | 5,11 | 211,50€ |
| 12984 | 105mm | 4,8 | 234,00€ |

| 1/2" 78mmL | | | |
|------------|------|------|--------|
| 11613 | 27mm | 0,34 | 7,50€ |
| 11614 | 30mm | 0,42 | 9,50€ |
| 11615 | 32mm | 0,38 | 10,00€ |
| 11616 | 33mm | 0,45 | 12,50€ |
| 11617 | 34mm | 0,40 | 13,00€ |
| 11618 | 35mm | 0,46 | 13,50€ |
| 11619 | 36mm | 0,47 | 14,00€ |

| 1/2" 78mmL | | | |
|------------|------|------|-------|
| 12061 | 10mm | 0,14 | 6,00€ |
| 12062 | 12mm | 0,15 | 6,00€ |
| 12063 | 13mm | 0,13 | 6,00€ |
| 12064 | 15mm | 0,17 | 6,50€ |
| 12065 | 16mm | 0,16 | 6,50€ |
| 12066 | 17mm | 0,18 | 6,50€ |
| 12067 | 18mm | 0,23 | 7,00€ |
| 12068 | 19mm | 0,21 | 7,00€ |
| 12069 | 21mm | 0,24 | 7,00€ |
| 12070 | 22mm | 0,28 | 7,00€ |
| 12071 | 24mm | 0,30 | 7,00€ |
| 12072 | 27mm | 0,35 | 8,00€ |

| 3/4" 90mmL | | | |
|------------|------|------|--------|
| 13723 | 19mm | 0,41 | 12,00€ |
| 13724 | 21mm | 0,48 | 12,00€ |
| 13725 | 22mm | 0,61 | 12,50€ |
| 13726 | 24mm | 0,56 | 12,50€ |
| 13727 | 26mm | 0,51 | 13,00€ |
| 13728 | 27mm | 0,50 | 13,00€ |
| 13729 | 29mm | 0,71 | 14,00€ |
| 13730 | 30mm | 0,68 | 14,00€ |
| 13731 | 32mm | 0,71 | 14,50€ |
| 13732 | 33mm | 0,78 | 15,50€ |
| 13733 | 34mm | 0,81 | 16,00€ |
| 13734 | 35mm | 0,80 | 16,50€ |
| 13735 | 36mm | 0,81 | 16,50€ |
| 13736 | 38mm | 0,83 | 17,00€ |

| EXTRA LUNGO 1" 90mmL | | | |
|----------------------|------|------|--------|
| 13745 | 28mm | 0,77 | 17,50€ |
| 13746 | 30mm | 0,95 | 17,50€ |
| 13747 | 32mm | 0,90 | 17,50€ |
| 13748 | 33mm | 0,89 | 18,00€ |

BUSSOLE UTENSILI SPECIALI PER MEZZI PESANTI

BUSSOLE PER COPRIMOZZI DI RIMORCHI BPW

| | | | | |
|----------------|------|---|---|--|
| 52914 | 3,16 | 1 | 4 | |
| 196,50€ | Kg | | | |

Estrazione boccola asse posteriore BPW.



120mm 8 FACCE
QUADRATO ESAGONALE 41mm

BUSSELLA DADI RUOTA RIMORCHI BPW

| | | | | |
|----------------|------|---|---|-------|
| 52915 | 2,94 | 1 | 8 | 1.500 |
| 177,50€ | Kg | | | |

Estrazione boccola asse posteriore BPW.



111mm OVALE
QUADRATO ESAGONALE 41mm

BUSSELLA DADI RUOTA RIMORCHI BPW

| | | | | |
|----------------|------|---|---|-------|
| 52916 | 2,57 | 1 | 8 | 1.000 |
| 169,50€ | Kg | | | |

Estrazione boccola asse posteriore BPW.



109mm 8 FACCE
QUADRATO ESAGONALE 41mm

BUSSELLA ASSI POSTERIORI RIMORCHI BPW

| | | | | |
|----------------|------|---|-------|--|
| 52917 | 1,11 | 1 | 1.000 | |
| 108,50€ | Kg | | | |

Specifico per boccole veicoli da 6,5-9 TON.



65mm OVALE
QUADRATO 3/4"

BUSSELLA PER COPRIMOZZI POSTERIORI ASSI RIMORCHI BPW 95MM

| | | | | |
|----------------|------|---|---|-------|
| 52918 | 2,05 | 1 | 8 | 1.500 |
| 130,00€ | Kg | | | |

Estrazione boccola asse posteriore BPW.



95mm
QUADRATO 3/4"

BUSSELLA DADI RUOTA RIMORCHI BPW

| | | | | |
|----------------|------|---|---|-------|
| 52919 | 2,80 | 1 | 8 | 1.500 |
| 161,50€ | Kg | | | |

Estrazione boccola asse posteriore BPW.



110mm 8 FACCE
QUADRATO 3/4"

BUSSELLA ESTRAZIONE CUSCINETTI ASSE RIMORCHIO BPW

| | | | | |
|----------------|------|---|----|-------|
| 52920 | 1,35 | 1 | 10 | 1.000 |
| 126,00€ | Kg | | | |

Specifico per il dato anteriore dei cuscinetti sui veicoli BPW 12 TON.



80mm
QUADRATO 3/4"

BUSSELLA ESTRAZIONE DADO ASSE POSTERIORE BPW

| | | | | |
|---------------|------|---|----|--|
| 52921 | 0,73 | 1 | 10 | |
| 92,00€ | Kg | | | |

Specifico per il dato anteriore dei cuscinetti sui veicoli BPW 6,5-9 TON.



65mm
QUADRATO 3/4"

BUSSELLA PER DADI CUSCINETTI ASSE BPW

| | | | | |
|----------------|------|---|----|-------|
| 52922 | 2,24 | 1 | 10 | 1.000 |
| 129,00€ | Kg | | | |

Specifico per rimorchi BPW 16 TON.



85mm 6 FACCE
QUADRATO 3/4"

BUSSELLA PER DADI SOSPENSIONI SCANIA

| | | | | |
|---------------|------|---|----|-------|
| 52923 | 0,45 | 1 | 12 | 1.500 |
| 40,00€ | Kg | | | |



28x37mm
QUADRATO 3/4"

BUSSELLA PER ASSE SOSPENSIONE SCANIA

| | | | | |
|---------------|------|---|-------|--|
| 52924 | 0,65 | 1 | 1.500 | |
| 46,50€ | Kg | | | |



34x46mm
QUADRATO 3/4"

BUSSELLA RUOTA ANTERIORE SCANIA

| | | | | |
|----------------|------|---|----|-------|
| 52925 | 1,95 | 1 | 10 | 1.500 |
| 124,00€ | Kg | | | |

Specifico per dado asse anteriore.



80mm 8 FACCE
QUADRATO ESAGONALE 41mm

BUSSELLA PER DADO RUOTA SCANIA

| | | | | |
|----------------|------|---|----|-------|
| 52926 | 2,93 | 1 | 24 | 1.500 |
| 158,00€ | Kg | | | |

Specifico per dado asse posteriore.



100mm 8 FACCE
QUADRATO 3/4"

BUSSELLA PER DADO SULLA BALESTRA MEZZI SCANIA

| | | | | |
|---------------|------|---|----|-------|
| 52927 | 0,78 | 1 | 20 | 1.000 |
| 54,50€ | Kg | | | |



34x56mm
QUADRATO 3/4"

BUSSELLA MOZZO SCANIA

| | | | | |
|----------------|------|---|----|-------|
| 52928 | 2,01 | 1 | 10 | 1.500 |
| 125,50€ | Kg | | | |

Specifico per mozzo asse anteriore.



80mm 8 FACCE
QUADRATO 3/4"

BUSSELLA DADO RUOTA SCANIA

| | | | | |
|----------------|------|---|---|-------|
| 52929 | 2,68 | 1 | 8 | 1.500 |
| 135,00€ | Kg | | | |

Specifico per dado mozzo terzo asse in veicoli 10 ton.



95mm 8 FACCE
QUADRATO 3/4"

BUSSOLE UTENSILI SPECIALI PER MEZZI PESANTI

UTENSILE PER FACILITARE L'INSTALLAZIONE DEL PARAOLIO POSTERIORE ALBERO MOTORE SCANIA

| | | | | |
|----------------|------|---|---|-------|
| 52930 | 2,86 | 1 | 4 | 1.500 |
| 108,00€ | Kg | | | |



SCANIA 310/320

PARAOLIO 0366303-R

BUSSOLA MEZZI SCANIA PER FAR RUOTARE L'ALBERO DI DISTRIBUZIONE

| | | | | |
|---------------|------|---|----|--|
| 52931 | 0,23 | 1 | 60 | |
| 36,50€ | Kg | | | |



QUADRATO 1/2"

BUSSOLA PER VALVOLA DI INIEZIONE ELETTROMAGNETICA SCANIA

| | | | | |
|---------------|------|---|----|-------|
| 52932 | 0,47 | 1 | 20 | 1.500 |
| 37,00€ | Kg | | | |



Ø 38mm

QUADRATO 1/2"

BUSSOLA PER DADI MOZZI SCANIA

| | | | | |
|----------------|------|---|---|--|
| 52933 | 3,05 | 1 | 5 | |
| 147,00€ | Kg | | | |



SCANIA 420

8 SETTORI

QUADRATO 3/4"

Ø Esterno: 11,6cm
Ø Interno: 10cm

BUSSOLA PER MOZZI PRIGIONIERI MEZZI BENZ/MAN

| | | | | |
|---------------|------|---|-------|--|
| 52934 | 1,05 | 1 | 1.000 | |
| 84,00€ | Kg | | | |



56mm

QUADRATO 3/4"

BUSSOLA PER MOZZI MEZZI BENZ / MAN

| | | | | |
|----------------|------|---|----|-------|
| 52936 | 1,58 | 1 | 10 | 1.500 |
| 151,50€ | Kg | | | |

Anche per furgoni.



80-95mm

6 SETTORI

BUSSOLA PER MOZZI MEZZI POSTERIORE BENZ / MAN

| | | | | |
|----------------|------|---|---|-------|
| 52937 | 3,05 | 1 | 6 | 1.500 |
| 208,00€ | Kg | | | |

Specifico per mozzi asse posteriore.



95-115mm

6 SETTORI

BUSSOLE BOCCOLA PER IVECO

| | | | | |
|----------------|------|---|---|--|
| 53430 | 2,90 | 1 | 8 | |
| 224,50€ | Kg | | | |



IVECO

12 FACCE

118X134mm

Ø Esterno: 134mm
Ø Interno: 110,5mm

BUSSOLA PER MOZZI PRIGIONIERI MEZZI BENZ/MAN

| | | | | |
|---------------|------|---|----|-------|
| 52935 | 0,97 | 1 | 10 | 1.000 |
| 89,50€ | Kg | | | |



60mm

QUADRATO 3/4"

BUSSOLA RIMOZIONE VALVOLA INIEZIONE MEZZI MAN, BENZ, SCANIA

| | | | | |
|---------------|------|---|----|-------|
| 52939 | 0,18 | 1 | 30 | 1.500 |
| 27,00€ | Kg | | | |



22-28mm

DIESEL

4 ALMENAS

BUSSOLA MEZZI MERCEDES / MAN PER DADO DEL DIFFERENZIALE POSTERIORE

| | | | | |
|----------------|------|---|---|-------|
| 52940 | 4,34 | 1 | 8 | 1.500 |
| 187,50€ | Kg | | | |



104mm

6 SETTORI

QUADRATO 3/4"

BUSSOLA PER DADO BRACCIO DELLO STERZO MEZZI BENZ / MAN

| | | | | |
|----------------|------|---|---|-------|
| 52938 | 3,22 | 1 | 6 | 1.500 |
| 154,50€ | Kg | | | |

Specifico per rimuovere il dado dell'asse di sterzo.



100mm

6 SETTORI

QUADRATO 3/4"

UTENSILE PER FAR GIRARE IL MOTORE TRAMITE L'INGRANAGGIO DI AVVIAMENTO

| | | | | |
|---------------|------|---|----|-------|
| 52941 | 0,54 | 1 | 20 | 1.500 |
| 59,50€ | Kg | | | |

Per Benz da 6, 8, 10 cilindri.
Per MAN de 12 cilindri.



UTENSILE PER FAR GIRARE IL MOTORE TRAMITE L'INGRANAGGIO DI AVVIAMENTO SU MOTORI MAN

| | | | | |
|---------------|------|---|----|-------|
| 52943 | 0,49 | 1 | 30 | 1.500 |
| 71,50€ | Kg | | | |



ESTRATTORE PER NODI SFERICI MEZZI PESANTI E VEICOLI COMMERCIALI

| | | | | |
|---------------|------|---|----|-------|
| 52944 | 0,94 | 1 | 20 | 1.500 |
| 95,50€ | Kg | | | |



30mm

ESTRATTORE PER NODI SFERICI MEZZI PESANTI E VEICOLI COMMERCIALI

| | | | | |
|----------------|------|---|----|--|
| 52945 | 2,74 | 1 | 24 | |
| 196,50€ | Kg | | | |



39mm

UTENSILE PER FAR GIRARE IL MOTORE TRAMITE L'INGRANAGGIO DI AVVIAMENTO PER MOTORI BENZ / MAN 2 INGRANAGGI

| | | | | |
|---------------|------|---|----|--|
| 52942 | 0,87 | 1 | 20 | |
| 77,50€ | Kg | | | |



Per Mercedes Actros e Atego.
Per Man da 5,6 e 8 cilindri.



CARROZZERIA

- KIT PER LA CARROZZERIA 117**
- CASCO PER BRASATURA 118**
- SERIE DI LEVE. 118**
- GIOCO DI UTILE PER SET**
- APERTURA AUTO 119**
- STRUMENTI PER SOSTITUZIONE**
- DI CRISTALLI 119**
- PINZA A SCATTO 120**
- PISTOLA PER SILICONE 122**
- VENTOSE 122**
- CINGHIA CON TENDITORE 122**
- SOPPORTO PER LA PITTURA 123**
- CARRELLO PER CONSERVAZIONE**
- DEI COMPONENTI 123**
- CAVALLETO 124**
- BOBINE 124**
- PROTEZIONE**
- POGGIAPIEDI 125**
- COPERTURA AUTO 125**
- TAPPETO 126**

SPECCHIO PER L'ISPEZIONE DELLE AMMACCATURE

N

53486

27,00€

0,3

10

40

320

Permette di rilevare qualsiasi ammaccatura, grande o piccola, in modo molto semplice e visibile, in qualsiasi parte della carrozzeria con il suo design lineare.

Ø 800mm

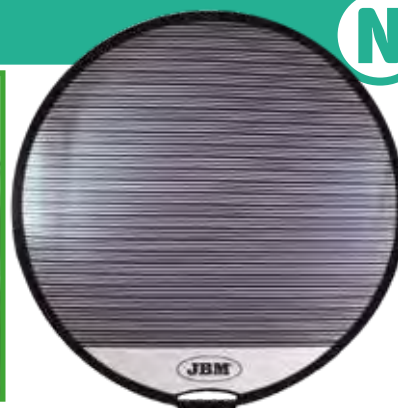

SET TASSI RIVESTITI IN PLASTICA

52876

169,50€

3,13

6

84

7
PCS

RIVESTITI
IN PLASTICA



| REF. | DESCRIZIONE | Kg | 10 | 40 | € |
|-------|---------------------------------|------|----|-------|--------|
| 12955 | TAS FACCIA PIATTA E TESTA OVALE | 0,29 | 25 | 99 | 31,00€ |
| 12956 | TAS RAIL | 0,31 | 25 | 99 | 31,00€ |
| 12957 | TAS TESTA OVALE | 0,37 | 25 | 99 | 31,00€ |
| 12958 | TAS MANIGLIA CUNEO | 0,41 | 25 | - | 31,00€ |
| 12959 | TAS A VIRGOLA | 0,30 | 25 | 99 | 31,00€ |
| 12960 | TAS TACCO | 0,18 | 25 | 1.500 | 31,00€ |
| 12961 | TAS A VIRGOLA CON MANIGLIA | 0,34 | 25 | - | 31,00€ |

SET MARTELLI SPECIALI DA CARROZIERE

51131

52,50€

5

5

100



| REF. | DESCRIZIONE | Kg | 10 | 40 | € |
|-------|-------------------------------|------|----|----|-------|
| 11541 | MARTELLA A TESTA PIATTA | 0,43 | 5 | 25 | 6,00€ |
| 11542 | MARTELLA PIATTO PICCOLO | 0,38 | 5 | 25 | 6,00€ |
| 11543 | MARTELLA PIATTO CONICO | 0,42 | 5 | 25 | 6,00€ |
| 11544 | TASSELLO | 0,69 | 5 | 25 | 5,50€ |
| 11545 | TASSELLO AD ALETTA | 0,79 | 5 | 25 | 5,50€ |
| 11546 | TASSELLO A DUE LATI SMUSSI | 0,81 | 5 | 25 | 5,50€ |
| 11547 | TASSELLO CUNEO A 8 O A SLITTA | 0,81 | 5 | 25 | 5,50€ |

KIT ATTREZZI RIPARA AMMACCATURE

53224

169,00€

3,9

5

40

32

PCS

- 1 pistola incollatrice (220-240V AC, 50 Hz, 40 W).
- 1 martello scorrevole per tirare le ammaccature grandi.
- 1 tirante per ammaccature (un minitirante oppure un tirante standard) per piccole ammaccature su superficie piana.
- 1 mezzo per la rimozione della colla.
- 1 raschiatore per una rimozione delicata dei cuscinetti di colla.
- 8 stick di colla neri (11 x 200 mm) ad alta adesione che permette di ottenere risultati di qualità.
- 19 occhielli di diverse dimensioni e diversa forma.

| REF. | DESCRIZIONE | Kg | 10 | 40 | € |
|-------|------------------------|------|----|-----|-------|
| 13842 | SET DI 5 DISCHI BLU | 0,15 | 10 | 100 | 5,50€ |
| 13843 | SET DI 4 DISCHI GIALLI | 0,1 | 10 | 100 | 4,00€ |
| 13844 | SET DI 10 DISCHI ROSSI | 0,3 | 10 | 100 | 7,50€ |
| 13845 | SET DI STICK DI COLLA | 0,95 | 10 | 100 | 5,50€ |



13842



13843



13844



13845



CASCO PER BRASATURA CON REGOLATORE MANUALE

| | | | |
|---------------|------|---|----|
| 53414 | 0,85 | 4 | 40 |
| 54,50€ | Kg | | |



CASCO PER BRASATURA CON REGOLATORE DIGITALE

| | | | |
|----------------|------|---|----|
| 53415 | 0,95 | 4 | 40 |
| 168,00€ | Kg | | |



SET DI 27 LEVE DI NYLON

| | | | | |
|---------------|------|----|-----|-------------------|
| 52788 | 1,18 | 10 | 140 | 27 PCS |
| 42,00€ | Kg | | | |



Set 27 leve con diverse curvature e finali che facilitano il lavoro sia all'interno che all'esterno dei veicoli. La sua ampia gamma permette di utilizzare lo strumento giusto per ogni lavoro e pezzo, facilitando il lavoro in luoghi difficili da raggiungere.



SET DI 4 CUSCINETTI GONFIABILI

| | | | | |
|---------------|------|---|----|-----|
| 52077 | 0,35 | 5 | 40 | 240 |
| 63,50€ | Kg | | | |

Inserendolo tra il vetro e il telaio della porta, consentono di aprire il veicolo facilmente e senza danneggiarlo.

4 - 5cm



Contenuto:
Cuscinetto da 16x16cm
Cuscinetto da 32x12cm
Cuscinetto da 19x6cm
Cuscinetto da 18x4,5cm
Pompa manuale

Pressione massima supportata: 100 Kg.

LEVA EUROPEA CON GANCIO

18" x 5/8

| | | | |
|--------------|------|---|----|
| 51360 | 0,75 | 5 | 20 |
| 6,50€ | Kg | | |

24" x 3/4

| | | | | |
|---------------|------|---|----|-----|
| 51361 | 1,46 | 5 | 10 | 500 |
| 11,00€ | Kg | | | |

Fabbricato in acciaio.



SET DI 4 LEVE EXTRALUNGHE

| | | | |
|----------------|------|---|----|
| 52977 | 8,61 | 1 | 48 |
| 108,00€ | Kg | | |

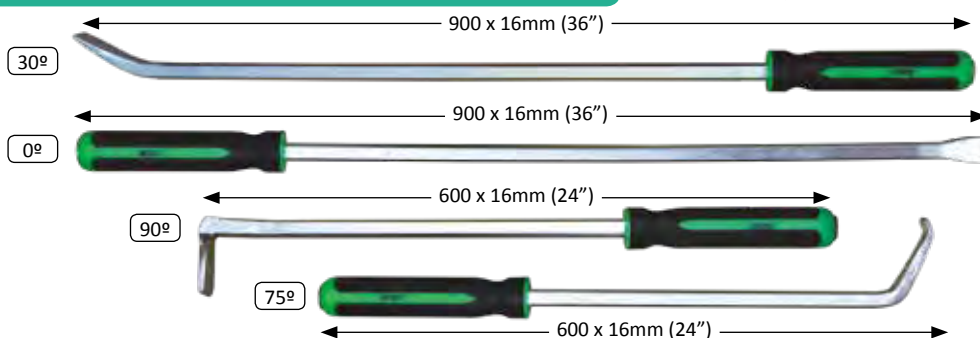

SET DI 2 LEVE

| | | | | |
|--------------|------|-----|----|-----|
| 52851 | 0,24 | 5 | 80 | 800 |
| 9,00€ | Kg | sub | ff | |

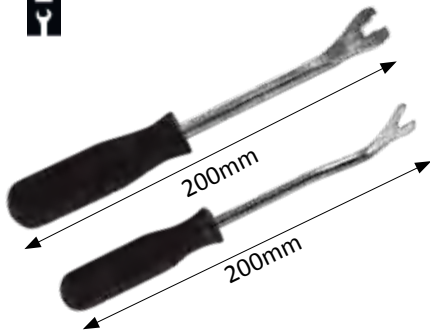

SET DI DUE LEVE DI METALLO

| | | | | |
|---------------|------|-----|----|-----|
| 52026 | 2,04 | 5 | 10 | 210 |
| 26,50€ | Kg | sub | ff | |

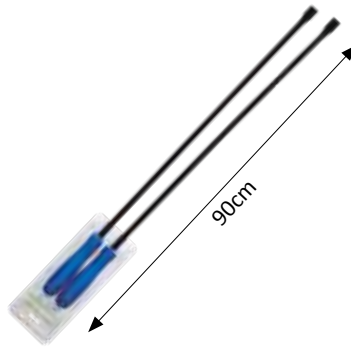

SET DI 4 LEVE DI NYLON A LAMA

| | | | | |
|---------------|------|-----|----|-----|
| 51832 | 0,55 | 12 | 24 | 192 |
| 21,50€ | Kg | sub | ff | |



SET DI 5 LEVE DI METALLO

| | | | | |
|---------------|------|-----|----|-----|
| 50903 | 1,95 | 4 | 8 | 200 |
| 26,50€ | Kg | sub | ff | |



60, 43, 38, 28, 18cm

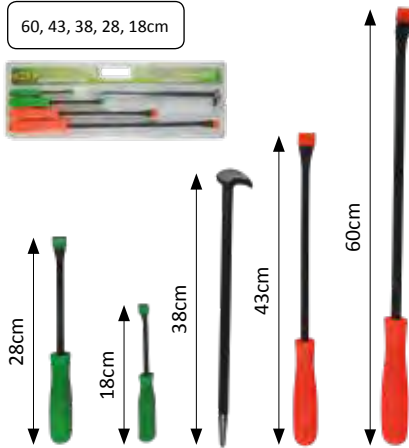

SET DI 5 LEVE DI NYLON

| | | | | |
|---------------|-----|-----|----|-----|
| 50901 | 0,4 | 5 | 20 | 240 |
| 19,00€ | Kg | sub | ff | |



SET DI 6 LEVE

| | | | | |
|---------------|------|-----|----|-----|
| 53110 | 1,42 | 6 | 12 | 144 |
| 24,50€ | Kg | sub | ff | |

5"x8.5mm
5"x10.3mm
5"x4.5mm
15"x8.5mm
15"x10.3mm
15"x4.5mm

6 PCS

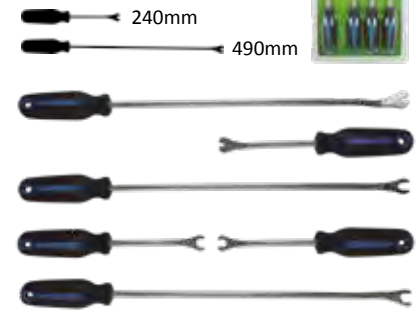

GIOCO DI UTILE PER APERTURA AUTO

| | | | |
|---------------|------|----|-----|
| 53230 | 0,65 | 24 | 360 |
| 17,00€ | Kg | ff | |

8 PCS

UNIVERSAL

Kit di attrezzi speciali per aprire veicoli senza chiave. Composto da cunei di plastica, leve e ganci curvi. Contiene una chiave universale per i coperchi del serbatoio del carburante. Per l'uso in officine e assistenze.

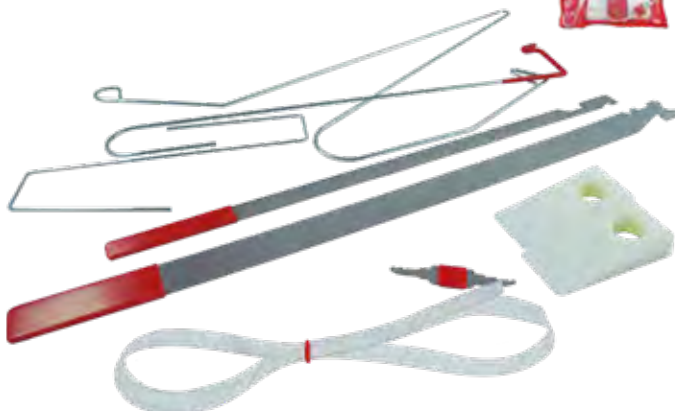

STRUMENTI PER SOSTITUZIONE DI CRISTALLI

| | | | |
|---------------|------|----|-----|
| 53232 | 1,15 | 10 | 160 |
| 43,00€ | Kg | ff | |



13813 5,50€
CAVO PER LA RIMOZIONE DEITERGICRISTALLI PER REF. 53232

13814 8,00€
MANIGLIE PER LA RIMOZIONE DEI TERGICRISTALLI PER RIF. 53232

PINZA A SCATTO PRESA PIANA

| | | | | |
|---------------|------|-----|----|-------|
| 52505 | 0,27 | 36 | 72 | 2.160 |
| 14,00€ | Kg | sub | ff | |

IMBALLO IN BOX
0-55mm



170mm

CR-MO



PINZA A SCATTO CON PRESA PIANA

| | | | | |
|---------------|------|-----|----|-------|
| 52506 | 0,29 | 36 | 72 | 2.160 |
| 15,00€ | Kg | sub | ff | |

IMBALLO IN BOX
0-50mm



170mm

CR-MO



PINZA A SCATTO PER SALDATURA CON PRESA PIANA

| | | | |
|---------------|------|----|-----|
| 52512 | 1,32 | 20 | 280 |
| 41,50€ | Kg | ff | |

IMBALLO IN BOX
0-210mm



440mm

CR-MO



PINZA A SCATTO PER SALDATURA

| | | | |
|---------------|------|----|-----|
| 52511 | 1,32 | 20 | 280 |
| 40,00€ | Kg | ff | |

IMBALLO IN BOX
0-225mm



440mm

CR-MO

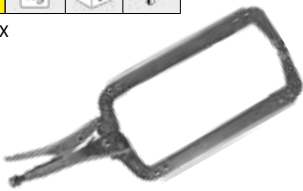

PINZA A SCATTO PRESA PIANA

| | | | |
|---------------|------|----|-----|
| 52507 | 0,77 | 30 | 420 |
| 23,00€ | Kg | ff | |

IMBALLO IN BOX
0-80mm



250mm

CR-MO



PINZA A SCATTO DOPPIA PRESA

| | | | |
|---------------|------|----|-----|
| 52504 | 1,14 | 30 | 480 |
| 21,50€ | Kg | ff | |

IMBALLO IN BOX
0-60mm



225mm

CR-MO



PINZA A SCATTO PER SALDATURA PRESA PIANA

| | | | | |
|---------------|------|-----|----|-----|
| 52503 | 0,85 | 10 | 30 | 540 |
| 26,50€ | Kg | sub | ff | |

0-105mm



280mm

CR-MO



PINZA A SCATTO PER SALDATURA

| | | | | |
|---------------|------|-----|----|-------|
| 52510 | 0,47 | 10 | 50 | 1.500 |
| 29,00€ | Kg | sub | ff | |

0-150mm



285mm

CR-MO



PINZA A SCATTO PER SALDATURA

| | | | | |
|---------------|------|-----|----|-----|
| 52502 | 0,84 | 10 | 30 | 540 |
| 25,00€ | Kg | sub | ff | |

0-110mm



280mm

CR-MO



PINZA A SCATTO

| | | | | | |
|---------------|------|-----|----|-------|--------------|
| 50577 | 0,47 | 5 | 40 | 1.000 | 230mm |
| 10,00€ | Kg | sub | ff | | CR-MO |



PINZA A SCATTO CON BECCO CURVO

| | | | | |
|---------------|------|-----|----|-------|
| 52386 | 0,44 | 10 | 50 | 1.500 |
| 21,00€ | Kg | sub | ff | |

Specifico per serraggio su tondi.
Grip 6 diverse misure di vite dado / esagonale.



52386
LISCIO



52387
DENTATO

| | | | | |
|---------------|------|-----|----|-------|
| 52387 | 0,44 | 10 | 50 | 1.000 |
| 22,00€ | Kg | sub | ff | |



215mm

PINZA AUTOBLOCCANTE

| | | | | | |
|---------------|-----|-----|----|-----|--------------|
| 52390 | 0,5 | 5 | 40 | 640 | 250mm |
| 31,50€ | Kg | sub | ff | | CR-MO |



PINZA A SCATTO BECCO A PAPPAGALLO

| | | | | | |
|---------------|------|-----|----|-----|--------------|
| 52388 | 0,82 | 5 | 20 | 320 | 305mm |
| 25,00€ | Kg | sub | ff | | CR-MO |



FINALE
RICURVO

MORSETTO AGGANCIAMENTO A PINZA

| | | | |
|---------------|------|----|-------|
| 52477 | 2,60 | 6 | 1.500 |
| 61,50€ | Kg | ff | |



2T

0-60mm



MORSETTO AGGANCIAMENTO A 90°

| | | | |
|---------------|------|----|-------|
| 52478 | 2,75 | 6 | 1.500 |
| 54,00€ | Kg | ff | |



5T

0-20mm



MORSETTO AGGANCIAMENTO A 90°

| | | |
|---------------|------|----|
| 52479 | 1,18 | 10 |
| 45,00€ | Kg | ff |



3T

0-20mm



MORSETTO AD ANELLO

| | | | |
|--------|------|---|-------|
| 52474 | 3,49 | 5 | 1.500 |
| 57,50€ | Kg | | |

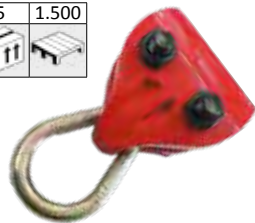

MORSETTO AD ANELLO ALLUNGATO

| | | | |
|--------|-----|----|-------|
| 52475 | 3,6 | 10 | 1.500 |
| 55,00€ | Kg | | |

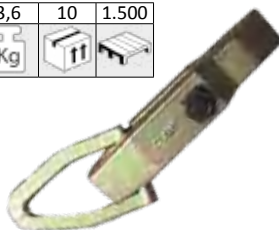

MORSETTO AD ANELLO

| | | | |
|--------|------|---|-------|
| 52476 | 3,04 | 6 | 1.500 |
| 55,00€ | Kg | | |

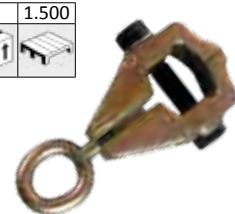

MINI MORSETTO AGGANCIATO A 2 VIE

| | | | |
|--------|----|---|--------|
| 52480 | 2 | 9 | 0-25mm |
| 48,50€ | Kg | | |



MORSETTO AGGANCIATO QUADRATO

| | | | | |
|--------|------|---|-------|--------|
| 52481 | 1,91 | 9 | 1.500 | 0-20mm |
| 46,00€ | Kg | | | |



Ancho punta 4x1,5mm

MORSETTO AGGANCIATO PIANO ANGOLO 45°

| | | | | |
|--------|------|---|-------|--------|
| 52482 | 2,13 | 9 | 1.500 | 0-10mm |
| 48,50€ | Kg | | | |



MORSETTO AGGANCIATO PIANO MINI

| | | | | |
|--------|------|---|-------|--------|
| 52483 | 2,02 | 9 | 1.500 | 0-10mm |
| 45,00€ | Kg | | | |



SET DI 6 PINZE AUTOBLOCCANTE

| | | | |
|---------|------|---|-----|
| 52385 | 3,72 | 6 | 120 |
| 108,00€ | Kg | | |



Tipo W: 195mm



Tipo T: 215mm



Tipo L: 225mm



Tipo J: 210mm



Tipo LL: 195mm



Tipo JJ: 195mm

14103 30,00€

TIPO W 195MM P/52385

14104 30,00€

TIPO T 215MM P/52385

14105 30,00€

TIPO L 225MM P/52385

14106 30,00€

TIPO J 210MM P/52385

14107 30,00€

TIPO LL 195MM P/52385

14108 30,00€

TIPO JJ 195MM P/52385

MORSETTO A PINZA

| | | | |
|--------|------|---|-------|
| 52487 | 2,27 | 9 | 1.000 |
| 55,50€ | Kg | | |



GANCI TIPO GAP

| | | | |
|--------|------|----|-------|
| 52484 | 1,19 | 11 | 1.500 |
| 58,50€ | Kg | | |



GANCI AD UNCINO

| | | | |
|--------|------|----|-------|
| 52485 | 1,17 | 11 | 1.000 |
| 47,50€ | Kg | | |



GANCI UNCINO + GAP

| | | | |
|--------|------|----|-------|
| 52486 | 1,21 | 11 | 1.500 |
| 53,00€ | Kg | | |



KIT DI 3 PINZE AUTOBLOCCANTE SUPERLUNGHE

| | | | | |
|--------|-----|---|---|-----|
| 52982 | 1,6 | 4 | 8 | 400 |
| 47,00€ | Kg | | | |

37cm: punta diritta
36cm: angolo di 45°
34cm: angolo di 90°

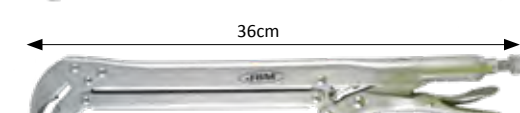

PISTOLA PER SILICONE

| | | | | |
|--------------|------|----|-----|-------|
| 52531 | 0,36 | 20 | 240 | 300ml |
| 6,50€ | Kg | ff | ff | 9" |



PISTOLA PER SILICONE

| | | | | |
|---------------|------|----|-----|-------|
| 52533 | 0,74 | 20 | 120 | 300ml |
| 11,00€ | Kg | ff | ff | 9" |



PISTOLA PER SILICONE A BATTERIA INCLUSA

| | | | | | |
|----------------|------|----|----|----|-------|
| 52674 | 2,59 | 1 | 4 | 64 | 300ml |
| 122,00€ | Kg | ff | ff | ff | 9" |

Batteria inclusa

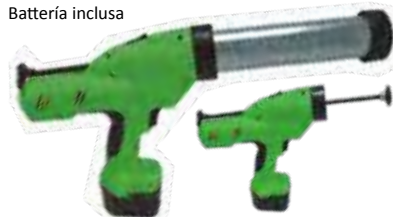

VENTOSA

SINGOLA

| | | | | | | |
|--------------|------|----|----|-----|---------|----|
| 52262 | 0,31 | 10 | 40 | 320 | 40Kg | ff |
| 7,00€ | Kg | ff | ff | ff | Ø 115mm | ff |



52262



52263

DOPPIA

| | | | | | | |
|---------------|------|----|----|-----|---------|----|
| 52263 | 0,59 | 10 | 24 | 288 | 70Kg | ff |
| 13,00€ | Kg | ff | ff | ff | Ø 115mm | ff |



52264



52265

TRIPLA

| | | | | | | |
|---------------|------|----|----|-----|---------|----|
| 52264 | 0,92 | 6 | 10 | 100 | 100Kg | ff |
| 19,50€ | Kg | ff | ff | ff | Ø 115mm | ff |

QUADRUPLA

| | | | | | |
|---------------|------|----|-----|---------|----|
| 52265 | 1,24 | 10 | 100 | 120Kg | ff |
| 22,00€ | Kg | ff | ff | Ø 115mm | ff |

VENTOSA DOPPIA SNODATA

| | | | | | | |
|---------------|------|----|----|-----|---------|----|
| 52765 | 0,87 | 5 | 20 | 120 | 80Kg | ff |
| 24,50€ | Kg | ff | ff | ff | Ø 120mm | ff |

Previsto per la manutenzione, l'installazione e la rimozione di parti del veicolo, sia in lamiera e vetro.

Maneggevolezza e conforme alla curvatura del potenziale superficiale.



KIT DA 2 VENTOSE E CINGHIA CON TENDITORE

| | | | | |
|---------------|------|----|-------|----|
| 52998 | 2,03 | 8 | 1.500 | ff |
| 61,00€ | Kg | ff | ff | ff |

80Kg Ø 120mm



5m x 25mm



VENTOSA ESTENSIBILE

| | | | | |
|---------------|------|----|----|----|
| 52267 | 1,07 | 20 | 80 | ff |
| 31,00€ | Kg | ff | ff | ff |

50Kg

Ø 115mm

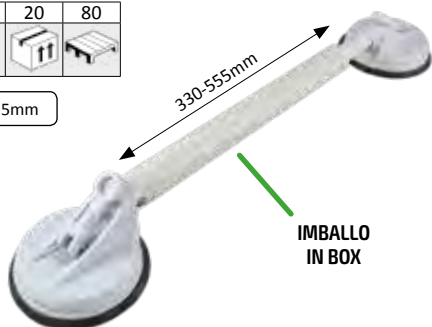

IMBALLO IN BOX

CINGHIA CON TENDITORE

5m x 25mm

| | | | | | |
|---------------|-----|----|----|-------|----|
| 52321 | 0,4 | 5 | 20 | 1.200 | ff |
| 10,00€ | Kg | ff | ff | ff | ff |

8m x 25mm

| | | | | |
|---------------|------|----|-------|----|
| 52327 | 0,46 | 20 | 1.000 | ff |
| 13,50€ | Kg | ff | ff | ff |



KIT DA 2 VENTOSE

52268
12,50€

| | |
|----|------|
| Kg | 0,19 |
| | 10 |
| | 20 |
| | 360 |



KIT DA 2 MINI VENTOSE

52295
5,50€

| | |
|----|-------|
| Kg | 0,15 |
| | 50 |
| | 100 |
| | 1.200 |



VENTOSA ESTRAZIONE CON MANICO

52589
11,00€

| | | | |
|------|----|----|-----|
| 0,28 | 10 | 40 | 640 |
| Kg | | | |

Ø 70mm

8Kg



SUPPORTO BASCULANTE PER PITTURA

53126
168,50€

| | | |
|------|---|----|
| 20,3 | 1 | 24 |
| Kg | | |



Ideale per porte, paraurti, ali, spoliers, ecc.

6 bracci di aggancio:

4 a gancio fisso

2 con foro

CARRELLO PER CONSERVAZIONE DEI COMPONENTI

53125
368,50€

| | |
|----|---|
| 51 | 1 |
| Kg | |

1800mm

895mm

585mm



SUPPORTO PER LA PITTURA

53134
104,50€

| | | |
|------|---|----|
| 14,7 | 1 | 36 |
| Kg | | |

1770mm

500mm

Telaio regolabile da 127 cm a 203 cm.
Completo con 6 ganci per parti da verniciare.

150Kg

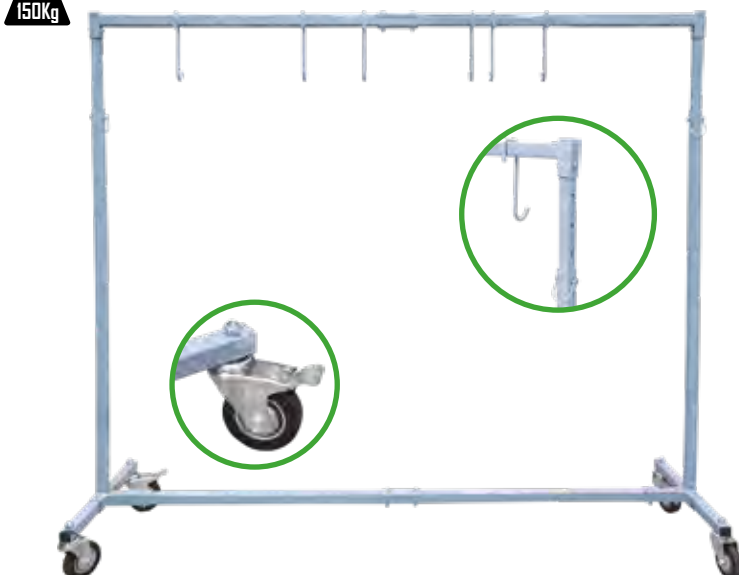

CONSUMABILI DA LAVORO

CAVALLETTO UNIVERSALE

53124

225,50€

| | |
|----|-------|
| Kg | 21,10 |
| ff | 1 |
| | 11 |

100Kg

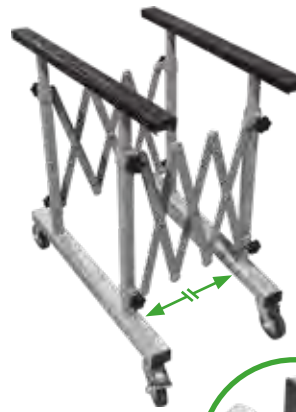

DIMENSIONI ALTEZZA

Min: 840mm
Max: 1320mm

DIMENSIONI LUNGHEZZA

Min: 225mm
Max: 1380mm

CAVALLETTI PROFESSIONALE

52749

54,00€

| | |
|----|------|
| Kg | 6,25 |
| ff | 1 |
| | 29 |

80cm

58cm



11959 3,50€

COPERTURA DI RICAMBIO
REF. 52749

CAVALLETTI PER VETRI AUTO

53080

74,50€

| | |
|----|------|
| Kg | 7,87 |
| ff | 1 |
| | 45 |



DIMENSIONI PIEGATO

1130mm 990mm

Stand di lavoro con ventosa in gomma morbida.

PORTA ROTOLO DI CARTA

53123

43,00€

| | | |
|-----|----|----|
| 2,6 | 5 | 35 |
| Kg | ff | |

900mm

460mm

440mm

Dimensioni di tubi: Ø18 x 1.2mm
Lama di taglio: 0,7mm.
Bobine di carta con larghezza fino a 40 cm.



CAVALLETTO "X"

53079

65,00€

| | | |
|------|----|----|
| 6,77 | 1 | 44 |
| Kg | ff | |



DIMENSIONI APERTO

660mm 600mm 870mm

DIMENSIONI PIEGATO

1140mm 600mm 300mm



SET ESPOSITORE + COPRISEDILE



COMPOSTO DA REF.: 52065,
52244, 52057, 52058

| | | | |
|---------------|-----|---|----|
| 50403 | 8,9 | 1 | 70 |
| 92,50€ | Kg | | |



COMPOSTO DA REF.: 51985,
51978, 52057, 52058, 50409

| | | | |
|----------------|----|---|----|
| 50400 | 17 | 1 | 35 |
| 152,00€ | Kg | | |



COMPOSTO DA REF.: 51985,
52244, 52057, 52058, 50409

| | | | |
|----------------|-------|---|----|
| 50410 | 12,44 | 1 | 35 |
| 152,00€ | Kg | | |

ESPOSITORE DA PARETE DI BOBINA COPRISEDILE, ROTOLO COPRIVOLANTE, POGGIAPIEDI

| | | | |
|---------------|------|---|----|
| 51985 | 5,02 | 1 | 40 |
| 79,50€ | Kg | | |

SENZA BOBINA



ESPOSITORE DA PARETE DI BOBINA COPRISEDILE

| | | | |
|---------------|------|---|----|
| 52065 | 2,19 | 1 | 70 |
| 35,50€ | Kg | | |

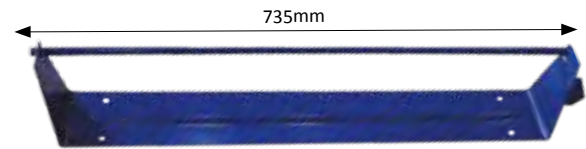

PROTEZIONE POGGIAPIEDI ANONIMA

| | | | |
|---------------|------|-------------|-----|
| 50409 | 3,54 | 250 | 160 |
| 26,50€ | Kg | UDS PACK | |

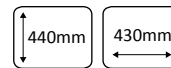

250 u.

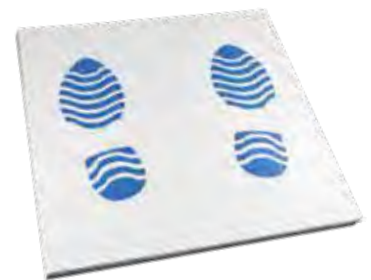

KIT DI MANUTENZIONE IN SACCHETTO SINGOLO

| | | | | |
|--------------|------|-----|-----|-------|
| 50916 | 0,07 | 100 | 400 | 4.800 |
| 1,00€ | Kg | | | |

DISTRIBUTORE



5in1



ROTOLO DI PELLICOLA COPRIVOLANTE

FILM

| | | | |
|--------------|------|----|-----|
| 52057 | 0,62 | 24 | 600 |
| 5,00€ | Kg | | |

Lunghezza: 200m
Larghezza: 12,5cm
Spessore: 23mc



MANICO

| | | | |
|--------------|------|-----|-------|
| 52058 | 0,06 | 125 | 2.500 |
| 6,50€ | Kg | | |

PACK DI 250 COPRIVOLANTE

| | | | |
|---------------|------|---|----|
| 51824 | 1,45 | 2 | 36 |
| 32,00€ | Kg | | |

250 u.



BOBINA DI COPRISEDILE

MODELLO CUIDAMOS (SPAGNOLO) / PICCOLO

| | | | | |
|---------------|------|---|----|---------------|
| 51978 | 6,53 | 4 | 49 | 25mc |
| 62,00€ | Kg | | | 250 U. |

MODELLO DISEGNO ANONIMO / PICCOLO

| | | | | |
|---------------|----|---|----|---------------|
| 52244 | 8 | 1 | 42 | 25mc |
| 64,00€ | Kg | | | 250 U. |



**NUEVO
DISEÑO**
25 MICRAS
DE GROSOR



52244

51978

GRANDE COPERTURA
DEL SEDILE



SEDE DI COPERTURA AUTO

| | |
|---------------|--|
| 53226 | |
| 12,00€ | |

| | |
|--|-----|
| | 0,3 |
| | 5 |
| | 50 |
| | 900 |

Nylon
universale



COPERTURA PROTEGGI PARAFANGO MAGNETICA

| | | | |
|---------------|------|----|-----|
| 51622 | 0,43 | 35 | 660 |
| 15,50€ | Kg | | |

PERSONALIZZABILE:
Dimensioni massime di
personalizzazione: 40x20cm

Due lati:
Uno vellutato e uno di plastica
Misure: 110cm x 64cm
4 Punti magnetici



TUTA DA LAVORO PER PROTEZIONE MONOUSO

| | | | |
|--------------|------|----|-----|
| 53413 | 0,15 | 50 | 400 |
| 4,50€ | Kg | | |

T. XL

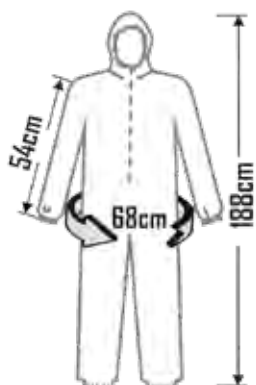

ESTENDIBILE

| | | | |
|---------------|-----|---|----|
| 53192 | 0,7 | 2 | 80 |
| 47,50€ | Kg | | |

Di schiuma EVA.

Misure del materasso piegato:
20cm x 40,5cm x 12,5cm.

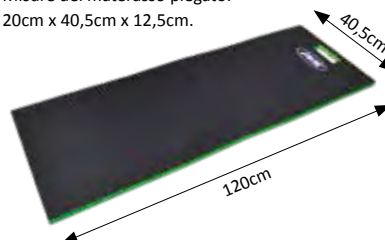

INDIVIDUALE

| | | | |
|---------------|------|---|-----|
| 53191 | 0,15 | 5 | 215 |
| 11,00€ | Kg | | |



31cm x 47cm.
Di schiuma EVA.



UTENSILI

| | |
|--|-----|
| RIPOSIZIONATORE DEI PISTONI DEL FRENO | 128 |
| SPURGOFRENI. | 129 |
| ESTRATTORI PER IL FILTRO DELL'OLIO. | 130 |
| TAPPI OLIO MOTORE. | 133 |
| ESTRATTORE DI INIETTORI. | 134 |
| SET SMERIGLIATORE PER SEDI INIETTORI. | 137 |
| KIT DI RIPARAZIONE FILETTI CON INSERTI HELICOIL. | 138 |
| TESTER DI PRESSIONE | 139 |
| VITE DI SICUREZZA. | 141 |
| CHIAVE PER CANDELE | 142 |
| ESTRATTORE DI PULEGGE | 143 |
| ESTRAZIONE DI AIRBAGS | 145 |
| DIREZIONE | 145 |
| ESTRATTORI PER SNODI SFERICI | 146 |
| ESTRATTORI DI GHIGLIOTTINA | 147 |
| EXTRACTORES DE GARRAS | 148 |
| ESTRATTORI DI TERMINALI | 148 |
| KIT PER L'ESTRAZIONE DI CUSCINETTI | 150 |
| CHIAVE DINAMOMETRICA | 152 |
| MISURAZIONE | 154 |
| MOLTIPLICATORE DI FORZA. | 155 |
| CENTRAGGIO DELLA FRIZIONE. | 156 |
| SISTEMA DI CONDIZIONAMENTO D'ARIA | 157 |
| SISTEMA DI RAFFREDDAMENTO | 158 |
| AMMORTIZZATORI | 159 |
| SPAZZOLE | 161 |
| ANELLI DEL PISTONE | 162 |
| STETOSCOPIO | 163 |
| PUNZONI | 163 |
| GANCI E BARRE MAGNETICHE | 164 |

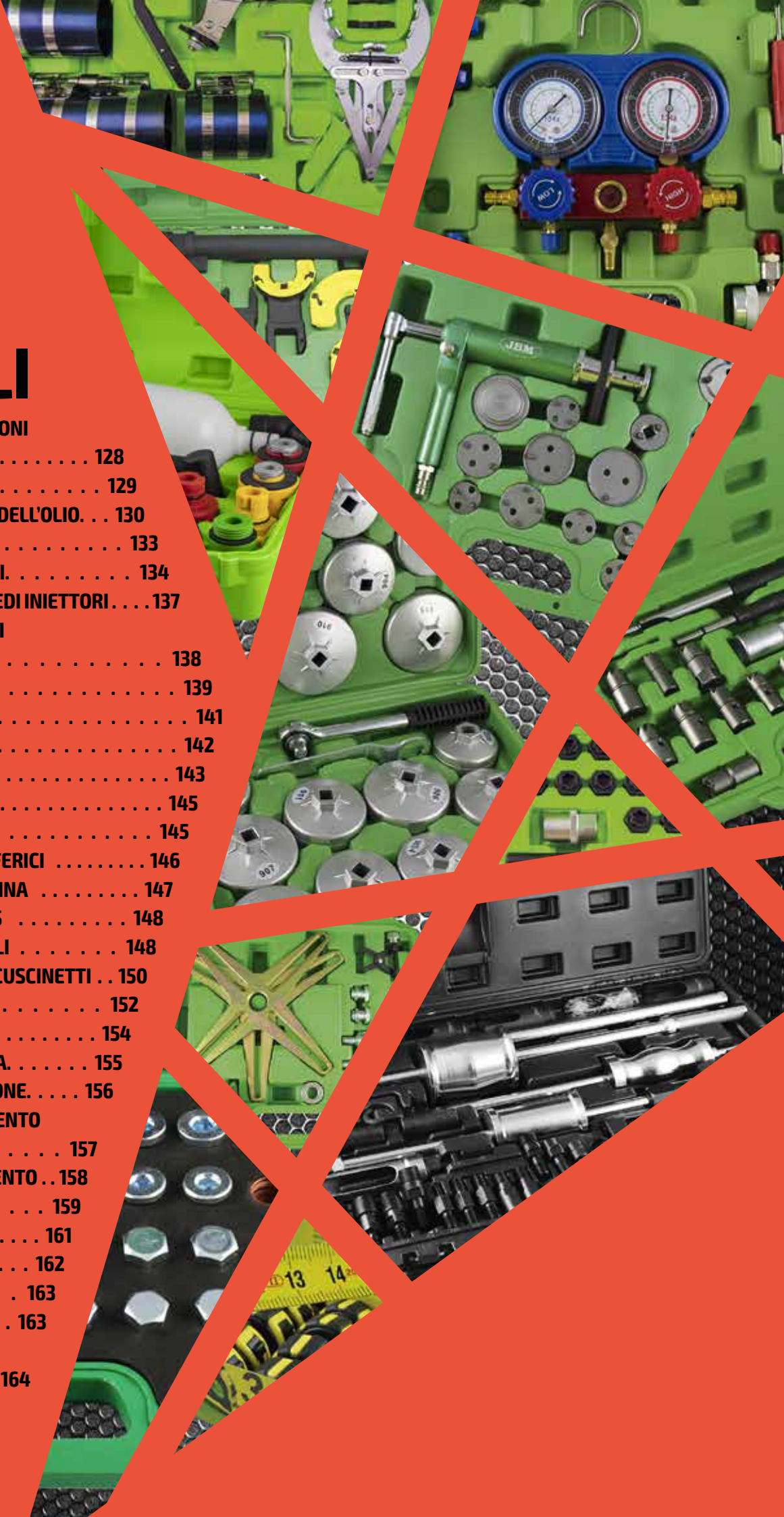

RIPOSIZIONATORE DEI PISTONI DEL FRENO

| | | | |
|----------------|------|----|----|
| 52636 | 3,16 | 5 | 75 |
| 139,50€ | Kg | 11 | 11 |

**16
PCS**

0: GM most 2-1/2" pistoni di diametro (Seville/Eldorado 79)

2: Citroën XM/Xantia (F/R), HONDA

3: Audi (F), Fiat, Alfa romeo (F), Ford Fiesta (F), Isuzu (F), Honda Concesto (F), Jaguar XJ6/XJ40 (F/R), BMW 318is/320i/325TD/518i/525i-1x/740i/850ci/M5 (F), Mercedes BENZ 190/200/300/420/560 serie (F), Mitsubishi Colt (F), Nissan Miera/Stanza/Sunny (F), Rover Austin/Metro200-400 series/Maestra/Montego (F), Toyota Camry (F), VOLVO (F), VW Passat/Golf GTI (F)

4: Ford Australia/NZ Telstar, Mazda (R), Saab 9000 (R)/Lumina, Toyota, Fiat 164 2.0 (R), Alfa Romeo Prelude/CRS 16i, Honda Saturn (R)/Grand Prix, GM

5: usare l'adattatore da 3/8" con la barra di allungamento e la chiave a cricchetto, quando è necessario applicare più forza al pistone.

6: Nissan Primera, VW Golf IV

7: Audi 80/90/V8+100/Coupe E (R), Rover 800 ABS, Subaru L+Z (R), Ford Sierra ABS/Granada/Scorpio ABS (R), Nissan Bluebird 1.8 Turbo/Silvia Turbo/Primera2.0i LS-GS-GSX (R), Peugeot 405 1.9Gi/Gri/Sri/Gtxi/Mi 16/605 2.0 Sri (R), Toyota Cecilia/Corolla GT/MR2 (R), VW Golf Gti/Jetta Synchro/Jetta Gti 16v, Passat CL, GL, GT, GT 16v, Corrado 16V scirocco GTX 16V(R), Citroën, Alfa romeo, Fiat, Honda, Jaguar, Renault, Saab, Seat, Lancia.

8: GM most 1-7/8" diameter pistons

9: GM most 2-1/8" diameter pistons A (Z): Renault (R21-Laguna (R)) E: Nissan Maximas/Cefiro

F (G): OPEL (disco posteriore)/ Fiat Stilo K: Citroën C5 M: Ford, Mini Cooper, Nissan Primera 03

N: Saab, Honda, Alfa Romeo 164 2.0 Twin Spark/2.0 Turbo (88-)/3.0 V6, Audi 200 (80-)/ Coupe GT SE (82-)/80/90/1Q0/200/Quattro (87-)/90/20V (88-), Ford Mondeo 2.0/Ghia, Lancia Themaalte (85-), Volkswagen Golf II GTI (83-87)/Sirocco 16V (84)

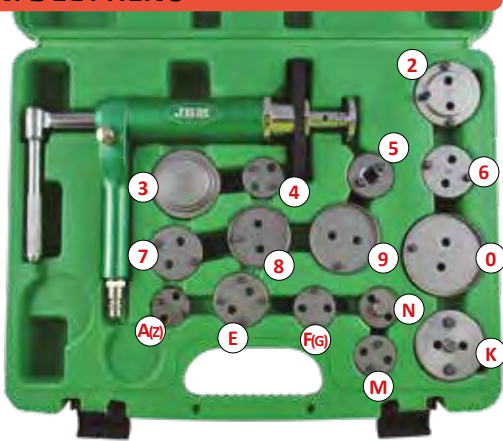

PISTOLA PER IL RIPOSIZIONAMENTO DEI FRENI

| | | | |
|---------------|------|----|-----|
| 51283 | 1,33 | 10 | 120 |
| 70,50€ | Kg | 11 | 11 |

Pressione normale di funzionamento: 5-8 bar
Pressione massima di funzionamento: 14 bar



RIPOSIZIONATORE DEI PISTONI DEL FRENO

| | | | |
|----------------|------|----|----|
| 52330 | 5,68 | 4 | 60 |
| 218,00€ | Kg | 11 | 11 |

**50
PCS**

Opel Peugeot
Citroën Renault

1pc: Pinza rotazione destra (con filettatura destrorsa) 1pc: Rotazione rampino a sinistra (con filettatura sinistra)

0 disco: Citroën 1: Disco 11: disco per Jaguar S Type 12: BMW Mini Disco

5: 13/32 "adattatore (5) con il Dr. Interior-pt 3/8 2: Citroen XM, Xantia u.a.

3: Alfa Romeo,Audi,Austin,BMW, Ford, Honda, Jaguar, Mercedes-Benz, Mitsubishi, Nissan Rover, Toyota, VW

4: 2.0.Ford Alfa Romeo 164, Mazda, Saab 9000, Subaru 6: Nissan Primera, VW-Golf IV

7: 8.0,9.0 Audi V8 100, Ford Scorpio Sierra ABS + ab 85, Prelude Honda, Nissan Silvia 1.8 turbo, 8000 Rover, Saab 9000, Subaru L + Z, VW-Golf + Passat

8: GM Motors G: Opel 9: GM Motors K: Citroën C5 0: GM Motors

K1, K2: Citroen, Renault. M: Ford A: Nissan Premira 2.0, Bluebird N: Saab, Honda

B: Ford, Lincoln, Subaru Z: Renault C: Mini Austin E: Cefiro, Maxima D: Citroën, Renault

F: Peugeot 206 CC / Hdi / GTI. Richiede una posteriore 16 millimetri pistone chiave.

P: Audi, BMW, Ford, Lancia, Pistone, Renault, Rover

J: 1.8-2.0 Alfa Romeo 155 TD 164 (93) 164 3.0 V6 (91), 80.90 Audi, A3, A4, A6, A8, Citroen ZX 2 Ql 16V, 16V TD Fiat Tipo, Uno Turbo (85) Crama TD, Ford Sierra (ABS bak). Granada (85) Crama TD, Ford Sierra (ABS bak). (Australia e Nuova Zelanda) Thunderbird Turbo, Honda CRX, 1.6L-16V (8-90). 1800 Accord (84-85) 2.0i. Prelude 16V (88), Legenda V6, Jaguar XJ 4 Oseries, Lancia Dadrà 2.0, Ei Tur (93), Delta 1.6 Gti, Nissan, Peugeot, Renault, Seat, Subaru, Volvo V40 e S40.

R: Ford (Australia e Nuova Zelanda) Teslar, Laser, Mazda 323 Gti, GTXX (86-), 929 (82-), RX7 (81-) 16V 626 (87-) 626 GT (86-) 929 V6 (88-), Mitsubishi Galant GL Si, Toyota Celica, Corolla GT, MR2

S: Audi 100 TQ (91), BMW 740i 8cyl (91), Lancia Delta 1.9 TD (95). 416. Proton Renault-maggior parte dei modelli, Renault Laguna 2.0 (94). Laguna 2.2. D (95) 2.0-2.2 Safrane V6 TD, Rover 623 Si, Volkswagen Golf GTU Mk I e IV, Passat VR6, Vento GT (92)

H6: BMW H7: BMW Pin 3.0 Pin 5.5 100g di grasso

½ "Brake System Pentagono Dr + bit 10 mm 56 millimetri

½ "DR + 14 millimetri maschio-tipo 38mm- per i freni del Pentagono sui freni posteriori di Opel Astra G, Zafira, intelligente

½ "DR + 19 millimetri maschio-tipo 8mm- Bendix Brake, Citroen, Peugeot, Renault

P1: Peugeot 307,308.



| | | | |
|---------------|------|----|-----|
| 51059 | 4,62 | 5 | 100 |
| 90,50€ | Kg | 11 | 11 |

**37
PCS**

Contenuto:

- 2 chiavi a brugola da 6 e 7 mm.

- 2 tavolette per i sistemi frenanti Mercedes e Opel.

- 3 cuscinetti d'appoggio da usare nelle pinze dei freni e per i lavori nelle aree con poco spazio disponibile.

- Contiene bottiglia a fisarmonica con olio lubrificante.

- Elenco dei modelli di veicoli e istruzioni per l'uso.

1pc: Pinza rotazione destra (con filettatura destrorsa) 1pc: Rotazione rampino a sinistra (con filettatura sinistra)

0: Disco 1: Disco 11: Disco per Jaguar tipo S 12: Disco per BMW mini

5: Adattatore 3/8 2: Citroen XM, Xantia (F/R)

3: Alfa Romeo,Audi,Austin,BMW,Ford,Honda,Jaguar,Mercedes-Benz, Mitsubishi,Nissan,Rover,Toyota,VW.

4: Alfa Romeo 164 2.0,Ford,Mazda,Saab 9000,Subaru. 6: Nissan Primera,VW-Golf IV.

7: Audi 80,90,V8 +100,Ford Sierra ABS+Scorpio ab 85,Honda Prelude Nissan Silvia 1.8 turbo,Rover 8000,Saab 9000,Subaru L+Z, VW-Golf +Passat.

8: GM Motors. 9: GM Motors. 0: GM Motors. M: Ford. N: Saab,Honda.

2: Renault. E: Cefiro ,Maxima. G: Opel. K: CitroenC5. K1,K2: Citroen,Renault.

A: disco a 2 denti da 1-3/16" per una Renault R21, Laguna. B: Ford,Lincoln,Subaru. C: Mini Austin.

D: Citroen,Renault. F: Opel (disco trasero) P: Audi,BMW,Ford,Lancia,Proton,Renault,Rover,VW.

J: Alfa Romeo 155 1.8-2.0 164 TD(93) 164 3.0 V6(91) Audi,80,90,A3,A4,A6,A8 Citroen ZX 2 Ql 16V,Fiat Tipo TD 16V,Uno Turbo(85) Crama TD, Ford Sierra(ABS bak),Granada (85),(Australia & NZ) Thunderbird Turbo,Honda CRX,1.6-16V (8-90),Accord 1800(84-85)2.0i,Prelude 16V(88),Legend V6,Jaguar XJ40series,Lancia Dedra 2.0 Ei Tur(93),Delta 1.6Gti,Nissan,Peugeot,Renault,Seat,Subaru,Volvo V40& S40.

R: Ford (Australia & NZ) Telstar,Laser, Mazda 323 Gti,GTXX(86-),929(82-),RX7(81-),626 16V(87-),626 GT(86-),929 V6(88-),Mitsubishi Galant GL Si, Toyota Celica,Corolla GT,MR2.

S: Audi 100TQ(91), BMW 740i 8cyl.(91), Lancia Delta 1.9 TD(95), Proton 416, Renault-most models, Renault Laguna 2.0 (94), Laguna 2.2 D(95),Safrane 2.0-2.2 TD V6, Rover 623 Si, Volkswagen Golf Gti Mk 3&4,Passat VR6, Vento GT(92).

H6: BMW H7: BMW Pin Ø 3.0 Pin Ø5.5 100g di grasso



RIPOSIZIONATORE DEI PISTONI DEL FRENO

| | | | |
|---------------|-----|----|-----|
| 53231 | 2,7 | 5 | 160 |
| 33,00€ | Kg | ff | ff |

22
PCS

- O: Piastra 1: Piastra
 0: General Motors (Ø Pistoni 21/2") 2: Citroën XM, Xantia
 3: Alfa Romeo, Audi, Austin, BMW, Ford, Honda, Jaguar, Mercedes-Benz, Mitsubishi, Nissan, Rover, Toyota, VW
 4: Alfa Romeo 164 2.0, Ford, Mazda, Saab 9000, Subaru
 5: Raccordo quadrato da 3/8" 6: Nissan Primera, VW Golf IV
 7: Audi 80/90; V8+100, Ford Sierra ABS+Scorpio de 1985, Honda Prelude, Nissan Silvia 1.8 turbo, Rover 8000, Saab 9000, Subaru L+Z, VW Golf + Passat
 8: General Motors (Ø Pistoni 17/8") 9: General Motors (Ø Pistoni 21/8")
 10: VAG, Renault, Volvo con freno di stazionamento elettronico
 A: Renault E: Nissan Maxima, Cefiro F: Opel K: Citroën C5
 K1: Citroën K2: Citroën M: Ford N: Saab, Honda

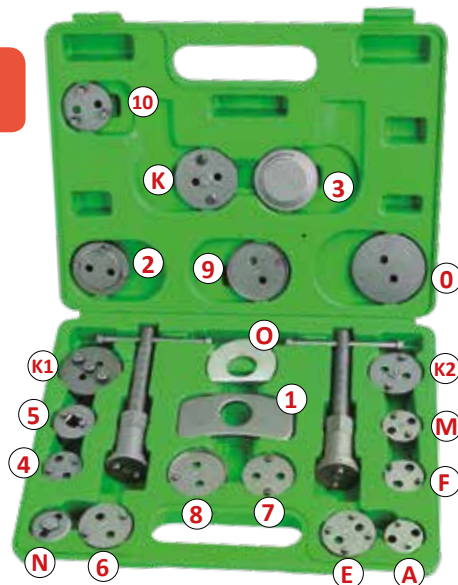

SPURGOFRENI

| | | | |
|---------------|------|----|-----|
| 52275 | 0,79 | 4 | 112 |
| 42,00€ | Kg | ff | ff |

0.75 L

- Temperatura: 10°C a 50°C
- Manichetta in silicone: 1m
- Pistola di soffio d'aria d'entrata 1/4"



VALIGETTA PORTAUTENSILI SPECIFICA PER IMPIANTI FRENO

| | | | |
|----------------|------|----|----|
| 52434 | 3,05 | 5 | 80 |
| 208,00€ | Kg | ff | ff |

- Contenuto:
- Chiavi freno
 - Pinza a molla freno
 - Driver impact
 - Occhiali Cacciavite
 - Strumento di Montaggio
 - Cacciavite con giunto cardanico
 - Freno Attrezzo speciale
 - Spazzola di pulizia
 - Spazzola Ottone
 - Strumento di Montaggio
 - Pinza per cavo freno
 - Lime per pinza freno



PINZA MOLLA DI RICHIAMO DEL FRENO

| | | | |
|--------------|------|----|----|
| 52625 | 0,32 | 6 | 48 |
| 8,00€ | Kg | ff | ff |

SPESSIMETRI PER PASTIGLIE FRENO

| | | | | |
|---------------|------|----|----|-----|
| 52455 | 0,26 | 20 | 40 | 864 |
| 18,00€ | Kg | ff | ff | ff |



| COLORE | METRIC | SAE |
|--------|-----------|----------------|
| Green | 8-10-12mm | 0.3150-0.4720" |
| Yellow | 4-5-6mm | 0.1575-0.2382" |
| Red | 2-3mm | 0.0787-0.1181" |

SPURGOFRENI

| | | | |
|----------------|------|----|----|
| 52191 | 9,41 | 1 | 12 |
| 283,00€ | Kg | ff | ff |

5L

INCLUDE TAPPI REF. 52328

- Pressione (regolabile) di lavoro: da 0 fino a 4 kg/cm²
- Prese d'entrata ed uscita de 1/2"
- Peso: 5Kg
- N° d'adattatori: 11 + 2 adattatori universali
- Gamma d'applicazioni: GM, Chrysler, Nissan



330mm 230mm 230mm



ADATTATORI PER SPURGO FRENI

Per veicoli GM, Chrysler, GM, Nissan

| | | | |
|----------------|------|----|-----|
| 52328 | 0,75 | 6 | 120 |
| 109,00€ | Kg | ff | ff |

9 Adattatori per impianti olio freni: Universalli n°1, n°2, n°3, n°4

SEPARATORE DEI PISTONI DEI FRENI

| | |
|---------------|------|
| 52315 | 0,88 |
| 24,50€ | Kg |
| 20 | ff |
| 430 | ff |



Apertura massima: 80mm

RIPOSIZIONATORE DEI PISTONI DEL FRENO UNIVERSALE

| | | | |
|---------------|-----|----|-----|
| 52906 | 1,3 | 5 | 500 |
| 84,00€ | Kg | ff | ff |

Alfa Romeo 164 2.0, Ford, Mazda, Saab 9000, Subaru, Nissan Primera, VW, Audi, Ford Sierra ABS + Scorpio ab 85, Honda Prelude, Nissan Silvia 1.8 turbo, Rover 8000, Saab 9000, Ford, Opel, BMW, Lancia, Proton, Renault, Rover, Peugeot 307, 308 A3- Iveco Daily, Volkswagon Passat 2.0 TDI 09, Renault Laguna

| REF. | DESCRIZIONE | Kg | ff | € |
|-------|-----------------|------|----|--------|
| 12974 | RICAMBIO 2 PINS | 0,15 | 50 | 23,50€ |
| 12975 | RICAMBIO 3 PINS | 0,17 | 50 | 25,50€ |



ESTRATTORI PER IL FILTRO DELL'OLIO

51332 4,19 5 60
108,00€ Kg **23**
 PCS



FABBRICATI
IN ALUMINIO

11376

11385



| REF. | N° DI PARTE | CARATTERISTICHE | Ø x FACCE | Kg | | | € |
|-------|-------------|---------------------------------|------------|------|---|----|--------|
| 11374 | 901 | Toyota, Nissan, Fiat Daihatsu | 65mm x 14 | 0,10 | 5 | 20 | 5,50 € |
| 11375 | 902 | Toyota, Daihatsu | 67mm x 14 | 0,08 | 5 | 20 | 5,50 € |
| 11376 | 903 | VW, Mercedes, BMW, Opel, Audi | 74mm x 14 | 0,09 | 5 | 20 | 5,50 € |
| 11377 | 903-1 | GM/AC, Wix, Ford, Isuzu | 75mm x 15 | 0,09 | 5 | 20 | 5,50 € |
| 11378 | 903-2 | VW, Audi, Seat, BMW, Renault | 74mm x 8 | 0,09 | 5 | 20 | 5,50 € |
| 11379 | 903-3 | Audi, Rover, Chrysler | 74mm x 15 | 0,11 | 5 | 20 | 5,50 € |
| 11380 | 903-4 | Toyota, Lexus | 73mm x 14 | 0,11 | 5 | 20 | 5,50 € |
| 11381 | 903-6 | Schlepper, Baumashinen | 75mm x 12 | 0,10 | 5 | 20 | 5,50 € |
| 11382 | 918 | Rover, Chrysler, Audi | 74mm x 15 | 0,11 | 5 | 20 | 5,50 € |
| 11383 | 904 | Nissan, Ford | 79mm x 15 | 0,10 | 2 | 20 | 5,50 € |
| 11384 | 905 | GM, Chrysler | 73mm x 15 | 0,12 | 5 | 20 | 5,50 € |
| 11385 | 905-1 | BMW, Mercedes, Opel, Audi, VW | 74mm x 14 | 0,10 | 5 | 20 | 5,50 € |
| 11386 | 906 | Baummaschinen, Schlepper | 84mm x 18 | 0,10 | 5 | 20 | 5,50 € |
| 11387 | 907 | Mitsubishi, Toyota | 89mm x 15 | 0,13 | 5 | 20 | 5,50 € |
| 11388 | 908 | Nissan, Toyota | 91mm x 15 | 0,14 | 5 | 20 | 5,50 € |
| 11389 | 915 | Honda Accord, Mitsubishi, Isuzu | 90mm x 15 | 0,16 | 5 | 20 | 5,50 € |
| 11390 | 910 | Toyota, Alfa Romeo, Ford | 95mm x 15 | 0,12 | 5 | 20 | 5,50 € |
| 11391 | 911 | Fiat, Renault, Citroën | 76mm x 12 | 0,09 | 5 | 20 | 5,50 € |
| 11392 | 911-1 | Subaru, Toyota, Honda, Nissan | 80mm x 15 | 0,09 | 5 | 20 | 5,50 € |
| 11393 | 914 | Mazda, Toyota | 101mm x 15 | 0,18 | 5 | 20 | 5,50 € |
| 11394 | 909 | Isuzu, Nissan | 92mm x 15 | 0,14 | 5 | 20 | 5,50 € |

BUSSOLE D'ESTRAZIONE PER IL FILTRO DELL'OLIO



52311



52312



52313



52314



52809



53441



52311 0,13 6 72 1.728
16,50€ Kg

42mm
GRUPPO VAG

52312 0,1 10 100 1.728
13,50€ Kg

74mm x 14C
VW, MERCEDES, BMW, AUDI, OPEL

52313 0,2 6 72 216
13,50€ Kg

84mm x 14C
VOLVO 540, 560, 570, 580

52314 0,28 5 50 600
15,50€ Kg

87mm x 16C
BMW, VOLVO IN SCATOLA

52809 0,15 10 100 600
10,50€ Kg

64,5mm x 14C
TOYOTA **3/8"**

53441 0,2 6 72
6,50€ Kg

76mm x 14C

ESTRATTORI PER IL FILTRO DELL'OLIO

52615 3,05 5 80
93,00€ Kg **9**
 PCS

Chiave regolabile a doppio senso
 Applicazione: 60-80mm

1/2" x1 **UNIVERSAL** 63-83mm

3/8" x8



6 - 27mm: Mercedes-Benz, Smart
 - 32mm: GM, Opel/Vauxhall, Mercedes-Benz
 - 36mm: Mercedes Diesel, BMW, Mini, Ford



15 - 88,8mm: Hunday, Kia



14 - 64,5mm: Toyota (Allion, Auris, Corolla, Prius, Voxy, etc.)
 - 64,5mm: Toyota, Lexus (6 Zyl.)
 - 74,2mm: Audi, BMW, Ford, Toyota, Volkswagen, Porsche, Mercedes-Benz



16 - 86,6mm: BMW 3+5+X, Volvo



ESTRATTORE DEL FILTRO DELL'OLIO FORD, CITROËN, PEUGEOT 2.0, 2.2 HDI, TDCI

| | | | | | |
|---------------|-----|---|----|-------|--|
| 53008 | 0,6 | 5 | 30 | 1.500 | |
| 16,00€ | Kg | | | | |



ESTRATTORE DEL FILTRO DELL'OLIO A ZAMPE PIATTE / A ZAMPE ROTONDE

| | | | | | |
|--------------|------|----|----|-------|--|
| 51352 | 0,34 | 10 | 40 | 1.280 | |
| 8,00€ | Kg | | | | |



57-118mm

| | | | | | |
|---------------|------|----|----|-----|--|
| 51353 | 0,57 | 10 | 40 | 960 | |
| 10,00€ | Kg | | | | |



72-136mm

Si può utilizzare con chiavi da 1/2" o da 3/8" / Range da 2 1/2" a 4" (63-102 mm)

Estrae tutti i filtri dell'olio, da 2 1/2" a 4" di diametro

| | | | | | |
|---------------|------|----|----|-------|--|
| 51934 | 0,38 | 10 | 40 | 1.200 | |
| 18,00€ | Kg | | | | |



57-118mm

| | | | | | |
|---------------|------|----|----|-------|--|
| 51923 | 0,56 | 10 | 40 | 1.020 | |
| 20,00€ | Kg | | | | |

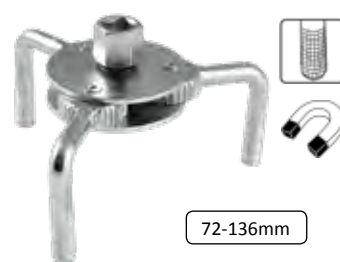

72-136mm

PINZA PER L'ESTRAZIONE DEI FILTRI DELL'OLIO

| | | | | | |
|---------------|------|---|----|-----|--|
| 51354 | 0,43 | 5 | 40 | 680 | |
| 12,00€ | Kg | | | | |

80-120mm



SET 5 ASTE PER IL CONTROLLO DELL'OLIO BENZ/AUDI

| | | | | | | |
|---------------|-----|---|----|-----|--|-----------------|
| 53206 | 0,4 | 5 | 50 | 300 | | 5 PCS |
| 30,00€ | Kg | | | | | |



Per controllare il liquido di trasmissione dell'olio nei motori Audi 100. La punta (prima 11mm) è la lettura del fluido freddo a 20° C. La seconda lettura è al minimo di 80° C. La terza lettura è al massimo di 80° C. Mantenere il livello del veicolo durante il controllo dell'ATF.

Asta dal motore per controllare il livello dell'olio, compatibile con un'ampia gamma di motori dal 1988 al 2005 nella gamma Mercedes.

| | | | | |
|--------------|------|---|-----|--|
| 13856 | 0,04 | 5 | 100 | |
| 9,00€ | Kg | | | |



ESTRATTORE PER FILTRI CAMION

| | | | | |
|---------------|-----|----|-----|--|
| 52518 | 1,4 | 12 | 480 | |
| 82,00€ | Kg | | | |

95-165mm



ESTRATTORE PER FILTRI A NASTRO

| | | | | |
|--------------|------|-----|----|-----|
| 52269 | 0,15 | 10 | 50 | 800 |
| 8,00€ | Kg | sub | ff | |

80-120mm



RICAMBIO 360mm

| | | | |
|--------------|------|-----|----|
| 11106 | 0,02 | 10 | 50 |
| 3,50€ | Kg | sub | ff |

ESTRATTORE FILTRO REGOLABILE

| | | | | |
|---------------|------|-----|----|-----|
| 52677 | 0,32 | 10 | 40 | 480 |
| 14,00€ | Kg | sub | ff | |

| | |
|---|------------|
| ∅ | 65 - 105mm |
|---|------------|



| | | | | |
|---------------|------|-----|----|-----|
| 52678 | 0,33 | 10 | 40 | 480 |
| 14,50€ | Kg | sub | ff | |

| | |
|---|-------------|
| ∅ | 110 - 155mm |
|---|-------------|



| REF. | DESCRIZIONE | PARA | Kg | sub | ff | € |
|-------|----------------|-------|------|-----|-----|--------|
| 11936 | RICAMBIO 383mm | 52677 | 0,03 | - | 100 | 4,50 € |
| 11937 | RICAMBIO 540mm | 52678 | 0,04 | 10 | 100 | 5,50 € |

ESTRATTORE FILTRI A CATENA

| | | | | |
|---------------|------|-----|----|-----|
| 52417 | 0,87 | 5 | 25 | 800 |
| 22,00€ | Kg | sub | ff | |

300mm

∅ 160mm



ESTRATTORE FILTRI A CINGHIA

| | | | | |
|---------------|------|-----|----|-------|
| 52416 | 0,34 | 5 | 50 | 1.050 |
| 10,50€ | Kg | sub | ff | |

540 x 20mm

∅ 150mm

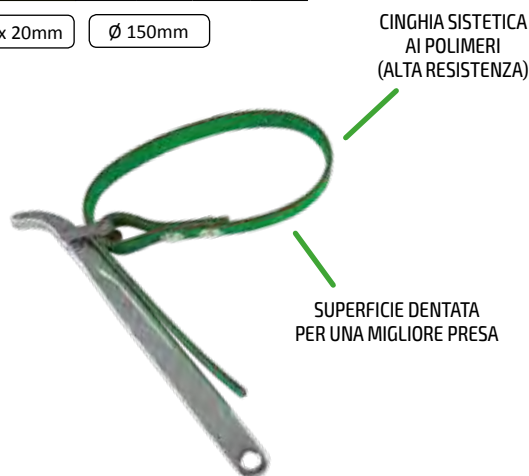

ESTRATTORE FILTRI A CATENA

∅ 60 - 140mm

| | | | | |
|---------------|------|-----|----|-----|
| 52607 | 0,86 | 6 | 24 | 432 |
| 41,50€ | Kg | sub | ff | |

∅ 60 - 195mm

| | | | | |
|---------------|------|-----|----|-----|
| 52608 | 0,99 | 6 | 24 | 576 |
| 47,00€ | Kg | sub | ff | |

VERSIONE EXTRALUNGHE



KIT DI BUSSOLE PER TAPPO CARTER

| | | | |
|---------------|------|----|-----|
| 52008 | 1,25 | 5 | 670 |
| 40,00€ | Kg | ff | ff |



Quadrato: bussola da 5/16" e da 3/8"
 Quadrato: bussola da 7, 8, 10, 11, 12, 13 e 14 mm
 Triangolo: bussola da 10mm
 Quadrato femmina: bussola da 10mm
 Esagonale: bussola da 8, 9, 10, 12, 14 e 17 mm



CHIAVI PER TAPPI DI CARICO

| | | | | | | | |
|--------------|------|-----|----|-------|--|--|----------|
| 52617 | 0,23 | 5 | 50 | 1.600 | | | 8 - 10mm |
| 5,50€ | Kg | sub | ff | ff | | | |



Per Citroën, Renault, Peugeot

CHIAVE PER TESTA CILINDRICA IN PLASTICA (VAG)

N

| | | | |
|--------------|-----|-----|--|
| 53472 | | | |
| 8,50€ | Kg | 0,1 | |
| | sub | 10 | |
| | ff | 100 | |



OEM: T10549

Funzione:
per l'estrazione di tappi di sughero in plastica.

Applicazioni:
Audi: A1, A3, A4, A5, A6, A7, Q3, Q5, Q7, TT, TTS
Seat: Alhambra, Leon, Toledo
Skoda: Octavia, Rapid, Superb, Yeti
VW: Beetle, Caddy, CC, Golf, Jetta, Passat, Polo, Scirocco, Sharan, Tiguan, Touran

KIT DI RIPARAZIONE PER TAPPI OLIO MOTORE

| | | | |
|---------------|----|------|--|
| 51337 | | | |
| 75,00€ | Kg | 1,58 | |
| | ff | 10 | |
| | ff | 180 | |



Tappi SKS3
 Inserti 1015
 Rondelle di rame

Contiene:
 M13X1,5P
 M15X1,5P
 M17X1,5P
 M20X1,5P

Inserti:
 1 unità x misura

Tappi: 5 unità x misura

Rondelle: 10 unità x misura

KIT DI RICAMBI PER LA RIPARAZIONE DELLA COPPA DELL'OLIO

| | | | | |
|---------------|------|----|-----|------------|
| 51403 | 0,13 | 50 | 100 | M13 |
| 14,50€ | Kg | ff | ff | x 1.5P |
| 51400 | 0,17 | 50 | 100 | M15 |
| 15,00€ | Kg | ff | ff | x 1.5P |
| 51401 | 0,15 | 1 | | M17 |
| 17,00€ | Kg | ff | | x 1.5P |
| 51402 | 0,1 | 1 | | M20 |
| 17,50€ | Kg | ff | | x 1.5P |



KIT DI REPARAZIONE DEL FILETTO DEI TAPPI DELLE COPPE D'OLIO

M - 13

| | | | |
|---------------|-----|-----|----|
| 53235 | 0,3 | 10 | 40 |
| 11,00€ | Kg | sub | ff |



M - 17

| | | | |
|---------------|-----|-----|----|
| 53237 | 0,3 | 10 | 40 |
| 14,00€ | Kg | sub | ff |



M - 15

| | | | |
|---------------|-----|-----|----|
| 53236 | 0,3 | 10 | 40 |
| 13,00€ | Kg | sub | ff |

M - 20

| | | | |
|---------------|-----|-----|----|
| 53238 | 0,4 | 10 | 40 |
| 16,50€ | Kg | sub | ff |

SET DI ESTRATTORE TAPPI DICARTER PLASTICHE

N

| | | | |
|---------------|-----|-----|--|
| 53473 | | | |
| 33,00€ | Kg | 0,4 | |
| | sub | 10 | |
| | ff | 50 | |
| | ff | 300 | |

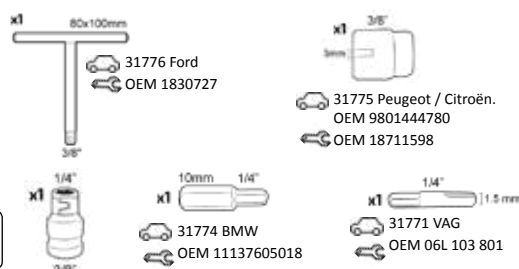

SET DI 3 TAPPI IN PLASTICA CARTER (VAG)

| | | | |
|---------------|------|-----|-----|
| 13969 | 0,01 | 10 | 500 |
| 15,00€ | Kg | sub | ff |

ESTRATTORE DI INIETTORI DIESEL PER CITROËN, PEUGEOT

| | | | |
|----------------|------|---|-----|
| 53069 | 3,44 | 5 | 150 |
| 123,50€ | Kg | | |

- 1x Ponte ripara ammaccature
- 3x Piedini di appoggio per ponte ripara ammaccature
- 2x Mandrino per estrattore – Ø17 mm, Ø25 mm
- 1x Dado tamburo per mandrino
- 2x Punta per iniettori 25 mm e 29 mm
- 1x Chiave esagonale di sicurezza 21 mm



KIT PER L'ESTRAZIONE DI INIETTORI

| | | | |
|----------------|------|---|-----|
| 51494 | 3,63 | 5 | 125 |
| 106,00€ | Kg | | |

Con estrattore a percussione per motori CDI e motori Mercedes CDI OM 611, 612, 613 ecc. per estrarre gli iniettori bloccati e common-rail senza smontare la testata.

La costruzione robusta permette una facile estrazione degli iniettori bloccati.

Materiale: acciaio S45C.
Lunghezza totale: 350 mm



Contenuto:
Estrattore a percussione 1,75 kg
Adattatore: M17 x 1,0

Adattatore: M27 x 1,0 per iniettore Bosch
Adattatore: leva w/M12 x 1.75P.

CHAVE DOPPIA APERTA PER INIETTORE

| | | | |
|---------------|------|---|----|
| 52821 | 0,24 | 6 | 96 |
| 23,50€ | Kg | | |

17mm



ESTRATTORE DI INIETTORI PER MERCEDES-BENZ

| | | | |
|----------------|------|---|-----|
| 51498 | 3,48 | 5 | 120 |
| 130,00€ | Kg | | |

Applicazioni: Per motori Mercedes-Benz CD 611, 612, 613, ecc.

Per estrarre iniettori common-rail bloccati senza dover smontare la testata. Specifico per collocazione in utensile pneumatico. Estrattore a percussione per iniettori non ben collocati, che possono essere tolti senza dover smontare o togliere il blocco cilindri.

SPECIALE PER UTENSILE PNEUMATICO



ESTRATTORE DI INIETTORI PER MERCEDES-BENZ CDI

| | | | |
|----------------|------|---|-----|
| 51499 | 3,61 | 5 | 125 |
| 153,00€ | Kg | | |

Kit per l'estrazione di iniettori per Mercedes CDI 4335. Questo kit di sette pezzi è stato specificamente creato per l'estrazione degli iniettori bloccati nei veicoli Mercedes Benz dotati di motore CDI.



KIT PER L'ESTRAZIONE DI INIETTORI

| | | | |
|----------------|-------|---|----|
| 52858 | 20,45 | 1 | 32 |
| 273,00€ | Kg | | |

Per rimuovere iniettori diesel.

Adatto per la maggior parte degli iniettori diesel con molti adattatori inclusi.



Componenti:

- 3 diversi martelli: 1,6 kg - 160 mm lungo, 2,7 kg - 460 mm lungo, 5.1kg - 600 mm di lunghezza.
- Grip maniglie con una separazione tra le lame: 13.7 x 18 mm, lunghezza 105 mm, 12,7 x 19 mm, 130 mm di lunghezza.

- 1/2 "vasi fessurati 6pt, 100mm di lunghezza. Dimensioni: 25, 27, 28, 29, 30.
- Estrattore iniettore: M17x1.0
- Adattatore con filettatura esterna: M27 x 1,0 e M25 x 1,0
- Adattatore con filettatura: M27 x 1,0 vite interna

ESTRATTORI UNIVERSALI PER INTERNI/ESTERNI

| | | | |
|---------------|-----|---|----|
| 53250 | 4,8 | 2 | 90 |
| 98,50€ | Kg | | |

Materiale: acciaio

Estrazione esterna: da 40 a 80 mm

Estrazione interna: da 50 a 150 mm

Include:

- Estrattore a triplo artiglio esteriore
- Triplo artiglio int. per l'estrazione dei cuscinetti
- 1 estrattore profondo
- 1 connettore a vite



ESTRATTORE DELLA POMPA DI INIEZIONE DIESEL (BMW)

| | | | |
|---------------|------|----|----|
| 53501 | 0,55 | 10 | 20 |
| 19,00€ | Kg | | |

Contiene le ruote dentate durante il montaggio della pompa di iniezione.



BWM: M47 / M47T2 / M47TU / M57 / M57TU
SERIES: E46 (318D-320D) (1988 - 2005) and E60, E61 (318TD-320TD-525D-530D-535) (2000 - 2006)
OEM1 13 5 191 | 13 5 192 | 13 5 190 BMW

ESTRATTORI DI TUBO D'INIEZIONE DIESEL

| | | | |
|---------------|-----|---|----|
| 53009 | 0,5 | 4 | 20 |
| 40,00€ | Kg | | |

| | | |
|--------------|--|--|
| 3/8" | | |
| 14, 17, 19mm | | |



ESTRATTORE RONDELLE DI INIETTORI

| | | | | |
|---------------|------|---|----|-----|
| 53522 | 0,09 | 5 | 20 | 300 |
| 21,50€ | Kg | | | |

Ø 4,5 - 15mm



2 PCS VALVOLA LAPPATURA SET

| | | | |
|--------------|------|---|----|
| 52850 | 0,11 | 6 | 72 |
| 7,00€ | Kg | | |

Ø 3,49-2,86mm
 Ø 1,59-2,06mm

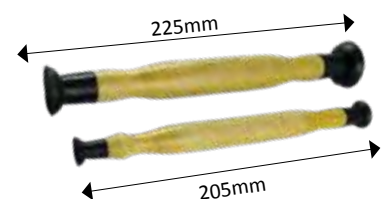

MISURATORE E TESTER DI SISTEMI D'INIEZIONE

| | | | |
|---------------|------|----|-----|
| 51493 | 0,96 | 5 | 120 |
| 87,00€ | Kg | ft | ft |

Strumento ideale per misurare con rapidità ed efficacia la quantità di carburante che ogni iniettore rinvia al serbatoio di carburante, che permette di sapere se qualche iniettore è danneggiato.

Il kit include:

- Supporto da appendere con 6 bottiglie di misurazione graduate.
- 6 tubi di misurazione.
- Tubi bianchi.
- Valigetta per contenere tutto il kit.

Per iniettori BOSCH, SIEMENS, DENSO e DELPHI

BOTTIGLIA + TUBO + COPERCHIO PER REF. 51493

| | | | |
|--------------|------|----|----|
| 12901 | 0,03 | 10 | 60 |
| 6,00€ | Kg | ft | ft |



ESTRATTORE PER SED DI INIETTORI VAG

| | | | |
|---------------|------|--|--|
| 52622 | | | |
| 72,00€ | | | |
| Kg | 2,73 | | |
| ft | 5 | | |
| ft | 120 | | |



Materiale: Cromo molibdeno SD45C.

Per motori VW, Audi diesel.

Applicazioni: 1.4 SDI, TDI, 1.9 D, SDI, TDI, TDI (PD), 2.0 TDI (PD) & (PD 4-VALVES), 2.5 TDI / TDI(PD), 2.8 TDI (PD), 2.7, 3.0 TDI (Common Rail), 4.2 TDI (Common Rail).

KIT PER L'ESTRAZIONE INIETTORI MERCEDES

| | | | |
|---------------|------|--|--|
| 52629 | | | |
| 93,00€ | | | |
| Kg | 1,22 | | |
| ft | 50 | | |
| ft | 440 | | |



Kit per l'estrazione di iniettori piezoelettrici per Mercedes C/E/S CLASS, VITO.

Questo kit di sette pezzi è stato specialmente creato per l'estrazione degli iniettori bloccati nei veicoli Mercedes Benz e dispositivo elettrico.

SET DI BUSSOLE PER POMPA DI INIEZIONE

| | | | | |
|---------------|------|----|-----|----------|
| 53330 | 0,75 | 20 | 144 | 5 |
| 30,50€ | Kg | ft | ft | PCS |

1/2" 1/4" CR-V
BOSCH injection pump
TDI
Common Rail



KIT DI 7 PEZZI PER IL SISTEMA D'INIEZIONE LAMBDA

| | | | | |
|---------------|------|----|----|-----|
| 51119 | 2,05 | 5 | 10 | 200 |
| 62,50€ | Kg | ft | ft | ft |

Contenuto:

- Bussola 1/2" da 29x9 a 90 mm di lung
- Bussola 1/2" da 7/8" a 50mm di lung
- Bussola 1/2" da 29x9 a 78mm di lung
- Bussola 3/8" da 7/8" x 6 a 90 mm di lung
- Bussola con innesto 3/8" da 7/8" x 6 a 80mm di lung
- Bussola 3/8" da 7/8" a 30mm di lung
- Bussola 3/8" da 1" e 1" 1/16 a 74mm lung



KIT PER IL SISTEMA D'INIEZIONE LAMBDA

| | | | | |
|----------------|------|----|-----|-----------|
| 51491 | 3,89 | 5 | 150 | 14 |
| 125,50€ | Kg | ft | ft | PCS |

- 17x78mm (12PT): Renault
- 19x78mm (12PT): VW, Polo, Audi, Seat, Mazda
- 20x78mm (6PT): Deschis Japon
- 27x78mm (6PT): Deschis Japon
- 21x90mm (12PT): Seat, Audi, VW, Skoda, Alfa Romeo, Mitsubishi
- 22x78mm (12PT): Seat, Audi, VW, Skoda, Opel
- 22x110mm (12PT): Mercedes, Citroen, Peugeot, Ford, Nissan, Mazda, Mitsubishi, Seat, Audi, VW, etc



POMPA INIETTORE DIESEL

| | | | | | |
|---------------|------|---|----|-------|--|
| 52801 | 0,13 | 5 | 50 | 1.500 | |
| 24,50€ | | | | | |



Durante la sostituzione della pompa di iniezione, filtri o altre parti, impedisce il ritorno del carburante nel serbatoio. Dopo l'assemblaggio delle parti sostituite permette di pompare il carburante fino alla linea di iniezione

CHIAVE PER Sonda LAMBDA

| | | | | |
|---------------|------|---|----|--|
| 52820 | 0,53 | 6 | 36 | |
| 36,00€ | | | | |

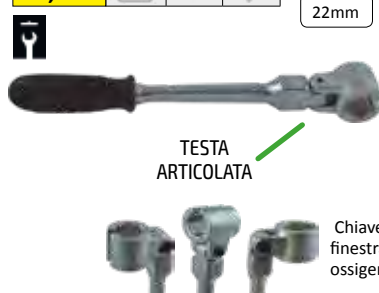

TESTA ARTICOLATA

| | | | | |
|---------------|------|---|----|--|
| 52822 | 0,41 | 5 | 20 | |
| 33,00€ | | | | |



TESTA ARTICOLATA

Chiave esagonale di 22 millimetri con finestra, consente l'estrazione di sensori di ossigeno situati in luoghi inaccessibili.

SET SMERIGLIATORE PER SEDI INIETTORI

| |
|---------------|
| 52813 |
| 97,00€ |

| | |
|--|------|
| | 2,23 |
| | 5 |
| | 180 |

17
PCS

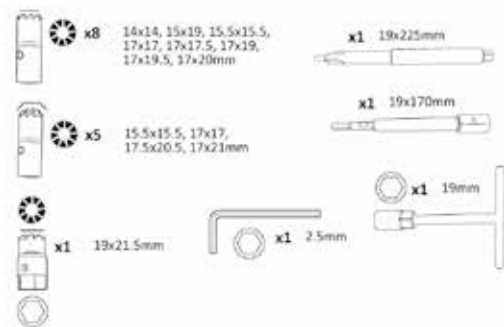

Kit di 17 alesatori per la pulizia degli iniettori

SET SMERIGLIATORE PER SEDI INIETTORI

| |
|---------------|
| 52273 |
| 58,50€ |

| | |
|--|------|
| | 1,28 |
| | 5 |
| | 220 |

8
PCS



Kit de 5 smerigliatori per pulire le sedi degli iniettori, quando nei motori diesel si revisionano o si sostituiscono gli iniettori.

VALIGETTA CON 58 PEZZI DI MASCHI E FILIERE RIVESTITI IN TITANIO METRICO E POLLICI

| |
|---------------|
| 50793 |
| 81,50€ |

| | |
|--|------|
| | 2,35 |
| | 5 |
| | 185 |

60
PCS



1 Maschio NPT (pollici): 1/8-27
 1 Filiere NPT (pollici): 1/8-27
 1 Portamaschi misto: M3~M12 e 3/16"~1/2"
 1 Portamaschi misto tipo T: M3~M6 e 4-40 ~ 6-32
 1 Portafilere misto: 25mm Ø
 1 Cacciavite
 1 Set di utensili per filettare e maschiare
 1 Set di utensili per filettare e maschiare in pollici
 10 Maschi (metrici): M3x0.5, M4x0.7, M5x0.8, M6x1.0, M7x1.0, M8x1.25, M9x1.25, M10x1.0, M10x1.5, M12x1.75

10 Maschi UNC (pollici): 4-40, 6-32, 8-32, 10-24, 12-24, 1/4-20, 5/16-18, 3/8-16, 7/16-14, 1/2-13
 6 Filiere UNF (pollici): 10-32, 1/4-28, 5/16-24, 3/8-24, 7/16-20, 1/2-20
 10 Filiere (metrici): M3x0.5, M4x0.7, M5x0.8, M6x1.0, M7x1.0, M8x1.25, M9x1.25, M10x1.0, M10x1.5, M12x1.75
 10 Filiere UNC (pollici): 4-40, 6-32, 8-32, 10-24, 12-24, 1/4-20, 5/16-18, 3/8-16, 7/16-14, 1/2-13
 6 Filiere UNF (pollici): 10-32, 1/4-28, 5/16-24, 3/8-24, 7/16-20, 1/2-20

VALIGETTA CON 58 PEZZI DI MASCHI E FILIERE RIVESTITI IN TITANIO PASSO METRICO

| |
|----------------|
| 50792 |
| 119,00€ |

| | |
|--|------|
| | 2,59 |
| | 6 |
| | 240 |

58
PCS



1 Maschio tipo NPT: 1/8 - 27
 1 Filiere tipo NPT: 1/8 - 27
 1 Portamaschi: M4 ~ M12
 1 Portamaschi tipo T: M3 ~ M6
 1 Portafilere: 25 mm Ø est
 1 Cacciavite.
 1 Set di utensili per filettare e maschiare.

17 Maschi: 2x0.4, 3x0.6, 3x0.5, 3.5x0.6, 4x0.75, 4x0.7, 5x0.8, 6x0.75, 6x1.0, 7x0.75, 7x1.0, 8x1.0, 8x1.25, 10x1.25, 10x1.5, 12x1.25, 12x1.75.

17 Filiere: 2x0.4, 3x0.6, 3x0.5, 3.5x0.6, 4x0.75, 4x0.7, 5x0.8, 6x0.75, 6x1.0, 7x0.75, 7x1.0, 8x1.0, 8x1.25, 10x1.25, 10x1.5, 12x1.25, 12x1.75.

KIT DI RIPARAZIONE FILETTI CON INSERTI HELICOIL

| | | | | |
|---------------|------|----|-------|----------|
| 53041 | 0,67 | 10 | 1.000 | M14x1,25 |
| 42,00€ | Kg | | | |

IDEALE PER CANDELE



| | | | | |
|----------------|------|---|-----|---------|
| 51898 | 1,81 | 4 | 252 | M18x2,5 |
| 109,00€ | Kg | | | |

| | | | | |
|----------------|------|---|-----|---------|
| 51899 | 2,12 | 4 | 252 | M20x2,5 |
| 109,00€ | Kg | | | |

Contenuto:
 - Punta di trapano
 - Maschio per filettare
 - Insettoro di Helicoil
 - Punteruolo di rottura
 - Set spirali in acciaio inox



KIT DI RIPARAZIONE FILETTI CON INSERTI HELICOIL

| | | | | | |
|----------------|-----|---|----|-----|---------|
| 51896 | 2,2 | 5 | 10 | 300 | 115 PCS |
| 121,00€ | Kg | | | | |



Contenuto:
 25 x M5x0.8
 25 x M6x1
 25 x M8x1.25
 25 x M10x1.5
 10 x M12x1.75

Punta di trapano
 Maschio per filettare
 Insettoro di Helicoil
 Punteruolo di rottura
 Set spirali in acciaio inox

| | | | | |
|----------------|------|---|-----|--------|
| 51897 | 2,21 | 6 | 378 | 32 PCS |
| 121,00€ | Kg | | | |



Contenuto:
 9 x M12x1.75
 9 x M14x2
 9 x M16x 2.0

Punta di trapano
 Maschio per filettare
 Insettoro di Helicoil
 Punteruolo di rottura
 Set spirali in acciaio inox

ELICOIDI DI SOSTITUZIONE



| REF. | DESCRIZIONE | Kg | | x5 | € |
|-------|-----------------------------------|------|----|--------|---|
| 52016 | ELICOIDI DI SOSTITUZIONE M5x0,8 | 0,01 | 10 | 2,50 € | |
| 52017 | ELICOIDI DI SOSTITUZIONE M6x1,0 | 0,01 | 10 | 3,00 € | |
| 52018 | ELICOIDI DI SOSTITUZIONE M8x1,25 | 0,05 | 10 | 3,00 € | |
| 52019 | ELICOIDI DI SOSTITUZIONE M10x1,50 | 0,01 | 10 | 4,00 € | |
| 52021 | ELICOIDI DI SOSTITUZIONE M12x1,75 | 0,02 | 10 | 4,00 € | |

| REF. | DESCRIZIONE | Kg | | x5 | € |
|-------|----------------------------------|------|----|---------|---|
| 52022 | ELICOIDI DI SOSTITUZIONE M14x2,0 | 0,03 | 10 | 5,00 € | |
| 52023 | ELICOIDI DI SOSTITUZIONE M16x2,0 | 0,05 | 10 | 7,50 € | |
| 52024 | ELICOIDI DI SOSTITUZIONE M18x2,5 | 0,08 | 10 | 12,00 € | |
| 52025 | ELICOIDI DI SOSTITUZIONE M20x2,5 | 0,01 | 10 | 14,50 € | |

RIPARATORE DEI FILETTI DELLE CANDELETTE

| | | | |
|----------------|------|----|--|
| 52076 | 0,85 | 10 | |
| 125,50€ | Kg | | |

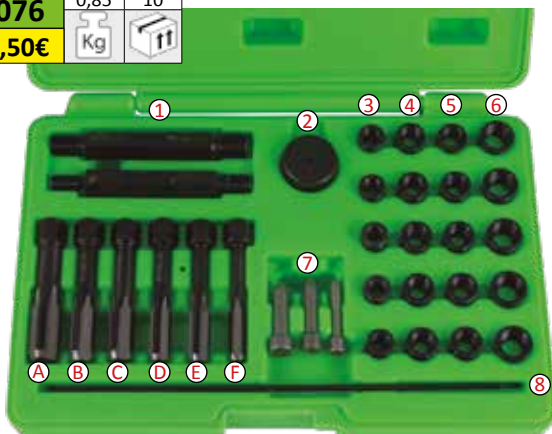

A. Inserzione di taglio M14 x 1.25 (per filetti da M12 x 1.25) - 1u
 B. Inserzione di taglio M12 x 1.25 - 1ud.
 C. Inserzione di taglio M12 x 1.0 (per filetti da M10 x 1.25) - 1u
 D. Inserzione di taglio M10 x 1.25 - 1ud.
 E. Inserzione di taglio M10 x 1.0 (per filetti da M8 x 1.0) - 1u
 F. Inserzione di taglio M8 x 1.0 - 1u

1. Utensile d'inserzione - 2u.
 2. Maniglia per pezzo 8 - 1u
 3. Filetti M8 x 1.0 - 5u
 4. Filetti M10 x 1.0 - 5u
 5. Filetti M10 x 1.25 - 5u
 6. Filetti M12 x 1.25 - 5u
 7. Teste d'inserzioni - 3u
 8. Bachetta d'inserzione di filetto - 1u

| REF. | DESCRIZIONE | Kg | | € |
|-------|------------------|------|---|---------|
| 11893 | INSERTI M8x1,0 | 0,01 | 5 | 7,50 € |
| 11894 | INSERTI M10x1,0 | 0,01 | 5 | 8,00 € |
| 11895 | INSERTI M10x1,25 | 0,01 | 5 | 8,50 € |
| 11896 | INSERTI M12x1,25 | 0,01 | 5 | 10,00 € |

TESTER DI PRESSIONE E VUOTO

53426

28,00€

Kg 0,9

ft 16



VACIO VACUUM 0-28 inHg (0-70 cmHg)

PRESSIONE PRESSURE 0-0,7 kg/cm² (0-10 PSIG)



TESTER DI PRESSIONE PER CIRCUITI OLIO

52754

1,31 10 160

53,00€

Kg **ft** **ft**



0-10 BAR
0-140 PSI

Utile per testare e diagnosticare problemi nei circuiti olio. Adattatori per la maggior parte dei veicoli disponibili sul mercato.



M10x1.0mm
M12x1.5mm
M14x1.5mm
M16x1.5mm
M18x1.5mm

MANOMETRO DELLA PRESSIONE DEL TURBOSOFFIANTE

N

53489

0,7 5 10

66,00€

Kg **ft** **ft**

0
-1-3 bar

2m



TESTER COMPRESIONE MOTORI DIESEL PER CAMION

52685

3,45 6 90

75,00€

Kg **ft** **ft**

0-70 BAR
0-100 PSI

Kit completo per misurare la compressione dei veicoli diesel. Vasta gamma di adattatori per misurare nella maggior parte dei veicoli sul mercato.

Accessori ad attacco rapido per lavori in punti di difficile accesso. Adattatore angolare e adattatore per filettature M18 e M24. Dispone di valvola di scarico e di sistema di ritenzione di lettura.



KIT VERIFICA COMPRESIONE BENZINA

52488

0,7 5 425

33,00€

Kg **ft** **ft**

Orologio calibrato doppia lettura (0-300psi, 0-2000kpa) con valvola di decompressione.

Il sistema di aggancio veloce consente di misurare rapidamente e con precisione in zone di difficile accesso; l'adattatore conico permette l'uso nella maggior parte dei veicoli sul mercato.



0-300 PSI
0-21 kg/cm²

VERIFICATORE DI PRESSIONE PER CIRCUITI DIESEL

51893

4,25 3 45

438,00€

Kg **ft** **ft**

0-1000 PSI
0-70 kg/cm²

Kit di verifica della pressione dei sistemi d'iniezione diesel. Range di lavoro fino a 70kg/cm² (1.000PSI). Misuratore ricoperto in gomma, con adattatori e prolungamento per lavori in punti di difficile accesso

Accessori ad attacco rapido e un ampio range di adattatori.

Adatto per la maggior parte dei veicoli, camion, furgoni, pullman, veicoli agricoli e motori marini diesel.

Con adattatori per: Alfa Romeo, BMW, Chrysler, Daewoo, Fiat, Ford, Hyundai,

Izusu, LandRover, LDV, Mazda, Mercedes, Mitsubishi, Nissan, Opel, PSA, Renault, Suzuki, Saab, Toyota, VAG, Opel, Volvo diesel.

Iniettori: M20, M22, M24 e Ford.



VERIFICATORE DI PRESSIONE PER CIRCUITI BENZINA

51894

438,00€

Kg 4,42

ft 3

ft 57

Verificatore di pressione adatto ad un'ampia gamma di sistemi: multipunto, meccanici e sistemi con iniezione elettronica.

Una gamma modulare composta da 3 kit di verifica con 2 serie di combinazioni ognuno, per ogni sistema d'iniezione di carburante.

Adatto per motori TBI, sistemi elettronici EFI e meccanici d'iniezione di carburante CEI.

① 0-7 BAR 0-100 PSI
② 0-3 BAR 0-35 PSI



KIT PER PROVE DI COMPRESSIONE DEI MOTORI DIESEL E A BENZINA

N

| | | | |
|----------------|-----|---|----|
| 53490 | 5,5 | 2 | 40 |
| 302,50€ | | | |

Alfa Romeo, BMW, Chrysler, Citroen, Daewoo, Fiat, Ford, Honda, Hyundai, Isuzu, Jeep, Kia, Lada, Lancia, Land Rover, LDV, Mazda, Mercedes, MG, Mitsubishi, Nissan, Peugeot, Renault, Rover, Saab, Ssangyong, Suzuki, Toyota, VAG, Vauxhall/Opel, Volvo.

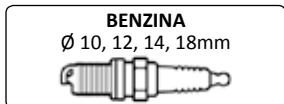
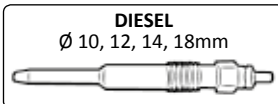

KIT VERIFICA COMPRESSIONE DIESEL

| | | | |
|---------------|------|---|----|
| 52489 | 2,15 | 6 | 72 |
| 57,50€ | | | |

0-1000 PSI
0-70 kg/cm²



Ford, BMW, Mercedes Benz, VW, Citroën, Mitsubishi, Toyota, Peugeot, Renault, Volvo, Mazda.

Kit completo per misurare la compressione dei veicoli diesel. Vasta gamma di adattatori per misurare nella maggior parte dei veicoli sul mercato. Accessori ad attacco rapido per lavori in punti di difficile accesso. Adattatore angolare e adattatore per filettature M18 e M24.

Dispone di valvola di scarico e di sistema di ritenzione di lettura

M18x1.5mm
M24x2.0mm
M24x1.5mm

M10x1.0x68mm
M10x1.25x54mm
M10x1.25x68mm
M12x1.25x45mm

SET UTENSILI DI RIMOZIONE PER CANDELETTE ROTTE

| | |
|----------------|---|
| 52815 | 1 |
| 125,50€ | |

| | |
|--|-----|
| | 1 |
| | 5 |
| | 240 |



Utile soprattutto per estrarre le punte degli elettrodi di riscaldamento in caso di rottura durante il processo di estrazione.

Facile rimozione senza sollevare la testa.

ESTRATTORE / RIPARATORE CANDELA

| | |
|----------------|------|
| 52305 | 1,79 |
| 131,00€ | |

| | |
|--|------|
| | 1,79 |
| | 10 |
| | 180 |

16 PCS



Estrattore di candele preriscaldamento di 16 pezzi. Questo set è utile per l'estrazione delle candele a incandescenza rotte o bloccate. Universale e ottimo per motori Mercedes-Benz CDI.

Estrae le candele a incandescenza rotte o danneggiate M8 e M10.

Include maschi di filettatura 1/4" M8 e M10 e punta progressiva ad alta resistenza di doppia misura M8 e M10.

ESTRATTORE DEI CONNETTORI DELLE CANDELETTE

| | | | |
|---------------|------|---|----|
| 52816 | 0,27 | 6 | 36 |
| 25,50€ | | | |

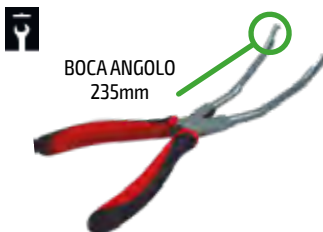

| | | | |
|---------------|------|---|----|
| 52817 | 0,28 | 6 | 36 |
| 24,00€ | | | |

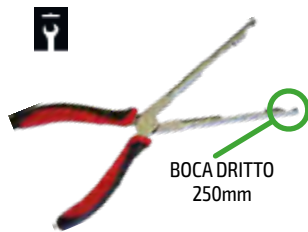

Pinza utile per la rimozione delle candele in riscaldatori diesel. Indicato per l'estrazione rapida.

Con i connettori situati in luoghi inaccessibili, le pinze permettono l'estrazione speciale senza il rischio di danneggiare il riscaldatore.

Impugnatura ergonomica in gomma.

CANDELETTE

SET VITE DI SICUREZZA PER BMW

| | | | | | |
|----------------|------|-----|----|------------------|-------|
| 53208 | 0,95 | 5 | 20 | 22 PCS | 41-60 |
| 119,00€ | Kg | 5x6 | ff | | |



SET DI BUSSOLE PER RIMUOVERE LE VITI DI SICUREZZA VW

| | | | | |
|---------------|------|-----|----|-----|
| 53207 | 1,55 | 5 | 10 | 330 |
| 96,00€ | Kg | 5x6 | ff | |

23
PCS

| | |
|------------|-------------|
| b51 / 6pt | b62 / 17pt |
| b52 / 7pt | abc0 / 10pt |
| b53 / 8pt | abc1 / 11pt |
| b54 / 9pt | abc2 / 13pt |
| b55 / 10pt | abc3 / 14pt |
| b56 / 11pt | abc4 / 15pt |
| b57 / 12pt | abc5 / 16pt |
| b58 / 13pt | abc6 / 17pt |
| b59 / 14pt | abc7 / 19pt |
| b60 / 15pt | abc8 / 20pt |
| b61 / 16pt | abc9 / 21pt |



SET VITE DI SICUREZZA PER VAG

| | | | |
|----------------|------|-----|----|
| 52823 | 0,94 | 5 | 20 |
| 169,50€ | Kg | 5x6 | ff |

Set appositamente progettato per rimuovere le viti di sicurezza su ruote veicoli Volkswagen, che copre praticamente il 100% della flotta di veicoli VW nel mercato.



KIT DI BUSSOLE TWIST DI 3/8" PER L'ESTRAZIONE DI DADI / BULLONI DI SICUREZZA



| | | | | |
|---------------|------|----|-----|---|
| 51998 | 0,69 | 20 | 360 | 10, 11, 12, 13, 14, 15, 16, 17, 19mm |
| 89,00€ | Kg | ff | | |



| | | | | |
|---------------|------|----|-------|---|
| 52962 | 0,72 | 20 | 1.500 | 6, 8, 10, 11, 12, 13, 14, 15, 16, 17, 19mm |
| 97,00€ | Kg | ff | | |



SET DI BUSSOLE PER RIMUOVERE LE VITI DI SICUREZZA PER MERCEDES

| | | | |
|----------------|-----|-----|----|
| 53328 | 0,6 | 5 | 20 |
| 101,50€ | Kg | 5x6 | ff |

12
PCS

5A, 5C, 5D, 5E, 5F,
5G, 5N, 5L, 5P, 5X



KIT DI BUSSOLE TWIST 1/2" PER L'ESTRAZIONE DI DADI / BULLONI DI SICUREZZA

| | | | | | |
|---------------|------|-----|----|-----|-----------------|
| 52153 | 0,93 | 5 | 20 | 300 | 1/2" |
| 74,00€ | Kg | 5x6 | ff | | |

17, 19, 21, 23,
27mm



ESTRATTORE DI BOBINA D'ACCENSIONE PER VW

| | |
|---------------|------|
| 51495 | 0,96 |
| 52,50€ | |
| Kg | |
| ff | 20 |
| ff | 200 |



Per il distacco e la collocazione delle bobine d'accensione con coperchio di motori ad iniezione VW ad 8 e 12 cilindri / 5 e 6 cilindri VW GOLF, BORA, e a 4 e 5 cilindri VW Passat, e a 6 cilindri, Sharan VW, Touareg, Phaeton.
Per il distacco e la collocazione delle bobine d'accensione con stadio di potenza di VW Polo, Golf 1.4, 1.6i, 1.4i CADDY, BORA 1.4, 1.6i Phaeton, Passat, Touran 1.6i, Transporter T4.



ESTRATTORE DI VITI DI REGOLAZIONE

51496

In acciaio al cromo-molibdeno con trattamento termico.

9,00€

Kg 0,09

Sub 12

ff 72

ff 2.000

Permette una rapida estrazione con l'aiuto delle filettature elicoidali che fungono da vite.



N° 1: 1/8" - 1/4" (M 3-6) N° 4: 7/16" - 9/16" (M 11-14)
 N° 2: 1/4" - 5/16" (M 6-8) N° 5: 9/16" - 3/4" (M 14-18)
 N° 3: 5/16" - 7/16" (M 8-11)

SET ESTRATTORE MASCHIO ROTTO

N

53502

0,6 20

35,50€

Kg **ff**

#2 M5 #7 M14
 #3 M6 #8 M16
 #4 M8 #9 M20
 #5 M10 #10 M22
 #6 M12



ESTRATTORE DI VITI DI REGOLAZIONE

51997

0,52 20 600

49,00€

Kg **Sub** **ff**

Base 12mm: Misure:
 3, 4, 5, 5,5, 6, 9, 10mm
 1/8", 3/16", 1/4", 3/8"
 Base di 16mm: Misure:
 11, 12, 14mm - 1/2"



SET DI BUSSOLE ESTRATTORE PER VITI PRIGIONIERE

52833

0,82 10

43,50€

Kg **ff**



1/2"

6, 8, 10, 12mm



KIT PER SVASATURA TUBI DI SCARICO

52700

0,93 6 12 528

20,00€

Kg **Sub** **ff** **ff**



3/16, 1/4, 5/16, 3/8, 1/2



SET DI BUSSOLE PER RIMUOVERE LE VITI DI SICUREZZA PER BMW

52802

0,62 20

42,00€

Kg **ff**



10 PCS

30/13 PT, 31/15 PT,
 32/16 PT, 33/17 PT,
 34/18 PT, 35/19PT,
 36/20 PT, 37/21 PT,
 38/22 PT, 40/23 PT

Utile per rimuovere le viti di sicurezza.



CHIAVE PER CANDELE ARTICOLATA

52691

0,79 24 480

54,00€

Kg **ff** **ff**



82mm

8, 9, 10, 12,
 14, 16mm

SISTEMA MECCANICO DI FISSAGGIO



3/8"

CHIAVE PER CANDELE MAGNETIZZATA

52317

0,39 12 72 2.880

20,50€

Kg **Sub** **ff** **ff**

250mm

∅16mm

3/8"

52316

0,29 12 72 2.880

19,50€

Kg **Sub** **ff** **ff**

250mm

∅14mm

3/8"

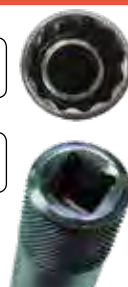

BUSSOLE PER CANDELE



ff

10054

2,00€

Kg 0,09

Sub 25

ff 100

16mm



10055

2,50€

Kg 0,14

Sub 25

ff 100

21mm



GOMMA ALL'INTERNO

ESTRATTORE

LEVA ARTICOLATA PER ALLENTARE PULEGGIA

| | | | |
|---------------|------|---|-----|
| 52961 | 2,38 | 8 | 192 |
| 83,50€ | Kg | | |

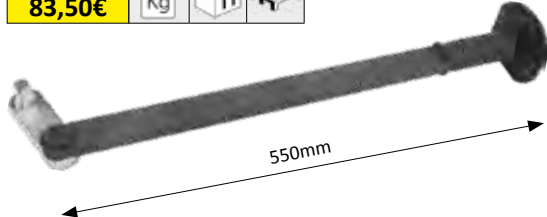

KIT DI CHIAVI CURVE PER ESTRAZIONE DELLA CINGHIA

| | | | |
|----------------|------|----|-----|
| 52189 | 2,27 | 10 | 120 |
| 101,50€ | Kg | | |



13, 15, 16, 17,
19mm



ESTRATTORE PER VITI PRIGIONIERE

| | | | | |
|---------------|------|---|----|-------|
| 51414 | 0,59 | 5 | 40 | 1.440 |
| 13,50€ | Kg | | | |



Ø Max: 20mm Ø Min: 15mm

ESTRATTORE DI DADI

| | | | |
|---------------|------|----|-------|
| 51368 | 0,41 | 50 | 1.000 |
| 37,50€ | Kg | | |



Ø Max: 42mm Ø Min: 33mm

ESTRATTORE DI DADI ASSIALI

| | | | |
|---------------|------|---|----|
| 51369 | 0,55 | 6 | 36 |
| 35,50€ | Kg | | |



Ø Max: 42mm Ø Min: 35mm

KIT ESTRAZIONE DI PULEGGE DI 30 PEZZI

| | | | |
|----------------|------|---|-----|
| 52293 | 3,11 | 5 | 130 |
| 108,00€ | Kg | | |

**30
PCS**

1/2" T50 c/33 denti 19mmX33T - 110mmL
1/2" M10 c/33 denti 19mmX33T - 110mmL
H15x33 denti 15mmx33T - 30mmL
H22x33 denti 22mmx33T - 30mmL
H22 H22 - 30mmL
H17x4 Pins speciale H17x4Pins- 30mmL
1/2"Dr. xH10Bit adattatori
H8 xH10 Punta 75mmL
H10xH10 Punta 75mmL
M8xH10 Punta 75mmL
M10xH10 Punta 75mmL
T40 xH10 Punta 75mmL
T50xH10 Punta 75mmL
M10XH12 Punta 64mmL
Speciale H22xH28 - 30mmL

Speciale H19xH28 - 30mmL
1/2"Dr.XM10 punta M10 - 140mmL
3/8":Dr.xM10 c/31 denti 14mmx31T-
85mmL
Speciale H21xH28 - 30mmL
Speciale H17 - 35mmL
Speciale H38x3Pins-20mmL
Speciale 15mmx33T- 30mmL
H10xFH10 x68L 68mmL
T50XH12 Bit 64mmL
Speciale H 17 x H 21-30mmL
Speciale H15xH28 - 30mmL
3/8" Adattator x10mm
1/2"Dr.XT50 punta T50 140mmL
1/2"Dr.XT50 punta T50 200mmL
1/2"Dr.XM10 punta T50 200mmL



CHIAVE PER SBLOCCARE PULEGGIA

| | | | |
|---------------|------|--|--|
| 52690 | | | |
| 37,00€ | | | |
| | 1,54 | | |
| | 10 | | |
| | 280 | | |

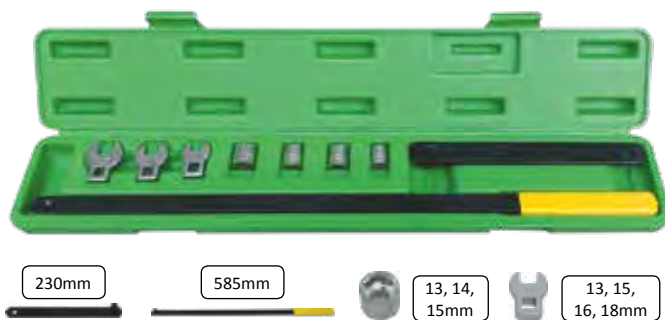

230mm

585mm

13, 14,
15mm

13, 15,
16, 18mm

KIT DI CHIAVI CURVE PER ESTRAZIONE DELLA CINGHIA

| | | | | |
|---------------|------|---|----|-----|
| 52832 | 1,35 | 5 | 10 | 160 |
| 64,50€ | Kg | | | |



12, 13, 14, 15, 16,
17, 18, 19mm



TESTA
INTERCAMBIABILE

KIT 18 PEZZI ESTRATTORE PULEGGE ALTERNATORE

| | | | |
|---------------|------|---|-----|
| 51259 | 2,10 | 5 | 180 |
| 53,00€ | Kg | | |

18
PCS



3 x Bussole combinati:
T50X113mm, M10X113mm, M10X90mm
1 x Bussole dentellato: M10x140mm
2 x Adattatori esagonali 19 e 22mm
3 x Bussole esagonali: 22x28mm, 19x28mm, 21x28mm

1 x Adattatori
Hex. 1/2" x 10mm
1 Punta M10x12x64L
6 X Punta 10mm x 75mm
Misure: T40, T50, M8, M10, H8, H10

RICAMBI DISPONIBILI

| | | | |
|---|---|--|---|
| 10494 6,00€ PROLUNGA DA 14cm | 10495 2,50€ INSERTO H10 | 10496 2,50€ INSERTO H8 | 10497 2,50€ INSERTO M10 |
| 10498 2,50€ INSERTO M8 | 10499 2,50€ INSERTO T40 | 10500 2,50€ INSERTO T50 | 10502 3,50€ INSERTO TORX M10 |
| 10501 9,50€ PROLUNGA INSERTO XZN M10 90mm | 10485 10,50€ PROLUNGA INSERTO XZN M10 110mm | 10486 10,50€ PROLUNGA INSERTO TORX T50 110mm | |

KIT D'ESTRAZIONE DI PULEGGE

| | | | |
|---------------|------|---|-----|
| 52624 | 1,26 | 5 | 360 |
| 16,50€ | Kg | | |



Per l'estrazione di pulegge, cinghia e albero.
Materiale: acciaio al carbonio
Diam. 35-85mm
Centrale flotante e estraibile

2 x inserti 5/16" de 4"
2 x inserti 1/4" de 3"19x28mm
3 x inserti 1/4" de 2"
3 x inserti 5/16" de 2"
1 x 5" inserti ALU
1 x punta di giro 3/4"

KIT ESTRAZIONE DELLA PULEGGIA POLY-V

| | | | |
|----------------|-----|---|-----|
| 51139 | | | |
| 183,00€ | | | |
| | 3,1 | | |
| | | 5 | |
| | | | 200 |



3 coni da 17 mm, 30 mm e 55 mm
1 perno filettato di 105x17 mm
1 prolunga da 22mm
1 prolunga da 72mm
1 base da 150 mm, con attacchi di 60 mm
1 base da 232 mm, con attacchi di 132 mm

Inserti:
2 viti di presa M10xP1, 5x30L
2 viti di presa M10xP1, 5x50L

ESTRATTORE FRIZIONE SPECIALE FIAT

| | | | |
|--------------|------|----|-------|
| 52190 | 0,39 | 10 | 1.000 |
| 9,00€ | Kg | | |

220 x110mm

Facilita l'accesso all'ase della forcella per la sua estrazione e successiva sostituzione del disco.

Lunghezza: 22cm, Larghezza: 11cm,
Vite: 1'5cm di lunghezza x 0'5cm diam.
Utile per smontare la forcella in frizioni di Fiat Ducato.



GANCI PER ESTRAZIONE DI GIUNTURA

| | | | | |
|--------------|------|----|----|-------|
| 53053 | 0,21 | 10 | 50 | 1.000 |
| 9,50€ | Kg | | | |

1x15.5cm / 1x16.5cm / 1x12cm



ESTRATTORE DI PULEGGE SCANALATE

| | | | |
|---------------|------|---|-----|
| 51500 | 1,55 | 5 | 640 |
| 43,00€ | Kg | | |

40-160mm



Per albero motore, alternatore, climatizzatore e pompa dell'acqua.
I bracci di ridotto profilo permettono un facile accesso alle zone difficili del motore.
Specifico per l'estrazione dell'albero motore scanalato, grippato e delle pulegge ausiliari.
Rang: 40-160mm

KIT DI 12 PEZZI PER L'ESTRAZIONE DI AIRBAGS

| | | | | | |
|---------------|------|---|----|-----|---------------|
| 51501 | 0,88 | 5 | 20 | 240 | 12 PCS |
| 43,00€ | Kg | | | | |



Inserti 0,5 PC 1/4" x 87mm (L):
 2 Torx:
 T25 (per BMW)
 T30 (per Audi, Opel, Renault, VW)
 2 Torx antintrusione:
 T25H (per BMW)
 T30H (per AUDI, BMW, Mercedes, Opel)
 1 esagonale: 5 mm (per AUDI)

Estrattore 0,7 PC:
 1 per Airbag lato guida. 1999-04 nuovo stile di carrozzeria di VW Passat, JETTA, GOLF
 2 per VW Passat B5, POLO, LUPO; AUDI A4, A6, Skoda Superb.
 2 per VW GOLF 4, New Beetle, SEAT, SKODA FABIA, AB Oktavia BJ.99
 1 per VW GOLF 4 (BJ, 1998-2004), VW PASSAT BJ.1997 AB, AB BORA BJ.1999
 1 per U.A VW modello: AB PASSAT BJ.2000

SUPPORTO PER LA REGOLAZIONE DEL BRACCIO DELLA SOSPENSIONE

| | | | |
|---------------|------|---|----|
| 51902 | 5,26 | 1 | 52 |
| 65,00€ | Kg | | |

Lunghezza: 118 cm
 Diam. tubo: 3,5 cm
 Distanza dei fissaggi:
 50, 45, 40, 35, 30 cm
 Fissaggio di 15x13 cm



10953 **13,50€**
 RIPOSTO
 PER REF. 51902

ALLINEAMENTO DELLE RUOTE

| | | | |
|---------------|------|----|-----|
| 51991 | 1,15 | 10 | 120 |
| 43,00€ | Kg | | |

Lunghezza totale aperta: 1950 mm
 Lunghezza totale chiusa: 1100 mm
 Misura della vite: M6x15 mm
 Tubo esterno: 20x20 in alluminio
 Tubo interno: 16x16 in ferro zincato



LEVA DI PROVA MANUALE PER LASCHI E GUASTI TRAPEZIO RUOTE

| | | | |
|---------------|----|----|-----|
| 52541 | 2 | 10 | 120 |
| 35,50€ | Kg | | |

Ideale per verificare:
 cuscinetto sterzo, cuscinetto ruota, silentblocks,
 stabilizzatore ruota, ecc.



ESTRATTORE DEL BRACCIO DELLA DIREZIONE

| | | | |
|---------------|------|---|-----|
| 52640 | 1,81 | 4 | 200 |
| 60,50€ | Kg | | |

Ø 28-35mm

| | | | |
|---------------|------|---|-----|
| 52641 | 2,28 | 4 | 200 |
| 65,00€ | Kg | | |

Ø 35-45mm



ESTRATTORE BRACCIO DIREZIONE

| | | | | |
|---------------|-----|---|----|-------|
| 52874 | 1,2 | 4 | 20 | 1.500 |
| 65,50€ | Kg | | | |

Ø 9-20mm

| | | | |
|---------------|------|----|-------|
| 52875 | 1,27 | 20 | 1.500 |
| 71,50€ | Kg | | |

Ø 14-23mm



KIT DEL BRACCIO DELLA DIREZIONE

| | | | |
|----------------|------|---|----|
| 52639 | 5,05 | 2 | 76 |
| 155,00€ | Kg | | |



Ø 30-35mm
Ø 35-40mm
Ø 40-45mm



ESTRATTORE IDRAULICO PER SNODI SFERICI

| | | | |
|----------------|------|---|----|
| 53384 | 7,30 | 2 | 62 |
| 143,50€ | Kg | | |



Overture: 100mm
Larghezza: 35mm



KIT ESTRATTORE-SEPARATORE DI SNODO SFERICO

| | | | |
|---------------|------|--|--|
| 51490 | | | |
| 31,00€ | | | |
| | 1,88 | | |
| | 5 | | |
| | 10 | | |
| | 240 | | |



Contenuto:
1 manico da utilizzare con un martello + 3 forcelle: 11/16", 15/16" e 1" 1/8
Forcelle in acciaio al cromo-

vanadio forgiato di alta resistenza.
I manici sono intercambiabili.
1 manico progettato per l'uso con martello pneumatico.

KIT DI 5 ESTRATTORI PER SNODI SFERICI

| | | | |
|----------------|------|---|----|
| 51123 | 5,29 | 4 | 96 |
| 137,50€ | Kg | | |

Versatile kit di estrattori.
Questo sistema permette la facile estrazione dei più popolari tipi di snodi sferici.

Il tipo di separazione dell'estrattore dal giunro permette di togliere lo snodo sferico senza i danni alla sede o agli altri elementi che possono causare altri tipi di estrattori.



ESTRATTORE PER SNODI SFERICI

| | | | |
|---------------|------|---|----|
| 52642 | 1,28 | 5 | 10 |
| 23,00€ | Kg | | |

Ø 20mm

Apertura Max: 60mm



2 MISURE REGOLABILI:
55 E 60mm

ESTRATTORI PER SNODI SFERICI MEZZI PESANTI

| | | | | |
|---------------|------|---|----|-----|
| 52698 | 1,27 | 5 | 20 | 720 |
| 26,50€ | Kg | | | |

Ø 17-22mm

Apertura: 20-50mm

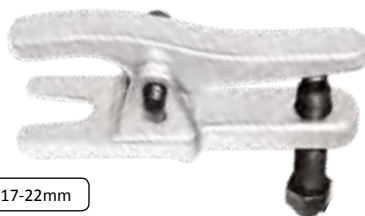

ESTRATTORI PER SNODI SFERICI

| | | | | |
|---------------|------|----|----|-------|
| 52699 | 0,77 | 10 | 30 | 1.050 |
| 17,00€ | Kg | | | |

Ø 18-22mm

Apertura:
15-50mm



ESTRATTORE PER CUSCINETTI CON 3 SERIE DI ARTIGLI

51122

155,50€

| | |
|----|-----|
| Kg | 4,5 |
| ff | 5 |
| ff | 120 |

Contenuto:
Guida centrale
Vite Artiglio corto
Artiglio medio
Artiglio lungo

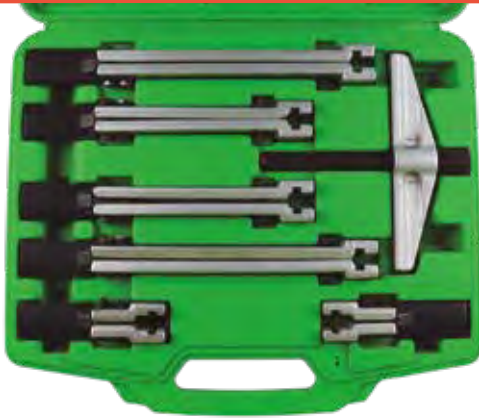

11492

40,50€

115 - 60mm

11493

43,00€

230- 170mm

11494

47,00€

280- 220mm



13679 6,50€
PUNTA PER REF. 51122



Min: 30mm
Max: 130mm

KIT PER L'ESTRAZIONE DI CUSCINETTI

51124

178,50€

| | | |
|------|----|-----|
| 3,29 | 5 | 120 |
| Kg | ff | ff |

Contenuto:
Estrattore universale (38,5mm)
Adattatore da 3/8" a 1/2" (10-14 mm)
Adattatore da 9/16" a 11/16" (15-19 mm)
Adattatore da 5/8" a 1" (18-25 mm)
Adattatore da 1" a 1" 1/4 (25-32 mm)



KIT DI ESTRATTORI A GHIGLIOTTINA

51125

65,00€

| | | |
|------|----|-----|
| 4,73 | 5 | 160 |
| Kg | ff | ff |

Capacità delle ghigliottine:
Kit da un pollice:
1/4", con 30 mm e 50 mm
Vite da 3/8" di 9,5x125 - 24 UNF
Testa da 3/8" x 16 UNC
Kit da 2 pollici:
1/4" - 3" 1/2, con 50 x 75 mm
Vite da 1/2" di 12,7x135 - 20 UNF
Testa da 3/8" x 16 UNC

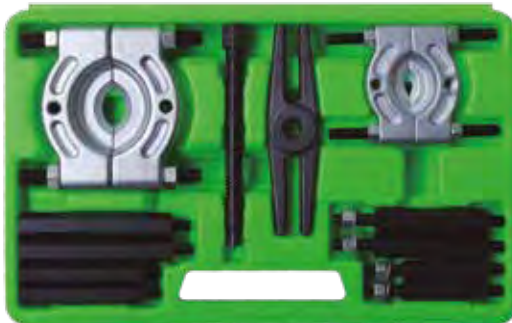

ESTRATTORI DI GHIGLIOTTINA

52626

34,50€

| | | |
|-----|----|-----|
| 2,5 | 5 | 800 |
| Kg | ff | ff |

75 - 105mm

52627

75,00€

| | | |
|------|----|-----|
| 5,27 | 2 | 231 |
| Kg | ff | ff |

105 - 150mm



Permette di estrarre facilmente i cuscinetti da vetture e veicoli commerciali. Estrae facilmente scatole cambio, pulegge e volani.

ESPOSITORE DI ESTRATTORE

53146

24,50€

| | |
|----|-----|
| Kg | 0,7 |
| ff | 5 |
| ff | 10 |
| ff | 200 |

ESTRATTORE NON INCLUSO



ESTRATTORE DI CUSCINETTI CON SFERE FALSE

53062

145,50€

| | |
|----|------|
| Kg | 2,41 |
| ff | 10 |
| ff | 180 |

5, 6, 8, 9,
11, 12,5mm



ESTRATTORE

ESTRATTORE A 2 ARTIGLI

| | | | | |
|---------------|-----|---|----|-------|
| 52727 | 0,2 | 5 | 10 | 1.152 |
| 30,00€ | Kg | | | |

25 - 70mm



50mm

| | | | |
|---------------|------|----|-----|
| 52728 | 1,23 | 10 | 500 |
| 64,00€ | Kg | | |

25 - 130mm



110mm

| | | | |
|----------------|-----|---|-----|
| 52729 | 3,4 | 3 | 240 |
| 153,00€ | Kg | | |

60 - 200mm



160mm

| | | | |
|----------------|------|---|----|
| 52730 | 8,64 | 2 | 72 |
| 341,00€ | Kg | | |

80 - 350mm



225mm



52727



52728

52729

52730

ESTRATTORE A 3 ARTIGLI

| | |
|---------------|------|
| 52731 | 1,08 |
| 37,50€ | Kg |

| | |
|--|-----|
| | 4 |
| | 24 |
| | 576 |

50 - 100mm

| | |
|---------------|------|
| 52732 | 2,53 |
| 67,50€ | Kg |

| | |
|--|----|
| | 4 |
| | 12 |
| | 72 |

70 - 150mm

| | |
|----------------|------|
| 52733 | 5,19 |
| 126,50€ | Kg |

| | |
|--|----|
| | 4 |
| | 72 |

95 - 200mm

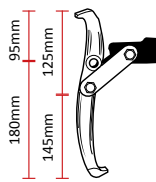

52731

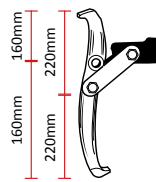

52732

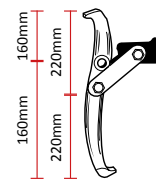

52733



ESTRATTORE A 3 ARTIGLI CONVERTIBILI IN 2 REVERSIBILI

| | | | | |
|---------------|------|---|----|-----|
| 52010 | 0,48 | 4 | 40 | 360 |
| 53,50€ | Kg | | | |

52010

Dimensioni dell'artiglio: 90 mm
Dimensioni per perno 124 mm
Artiglio: 12 mm
Ampiezza della croce: 66 mm
Profondità: 75mm

| | | | |
|---------------|------|----|-----|
| 52296 | 1,57 | 10 | 120 |
| 83,50€ | Kg | | |

52296

Dimensione dell'artiglio: 132mm
Dimensione per perno: 217mm
Artiglio: 14mm
Ampiezza della croce: 95mm
Profondità: 110mm

| | | | |
|----------------|------|---|----|
| 52297 | 3,33 | 6 | 48 |
| 122,50€ | Kg | | |

52298 CORTA E LARGA

Dimensione dell'artiglio: corta 134mm, larga 207mm
Dimensione per perno: 218mm
Artiglio: corta 13mm, larga 15mm
Ampiezza della croce: 95mm
Profondità: 110-180mm

| | | | |
|----------------|------|---|-----|
| 52298 | 2,65 | 6 | 396 |
| 162,00€ | Kg | | |

52297

Dimensione dell'artiglio: 210mm
Dimensione per perno: 313mm
Artiglio: 15mm
Ampiezza della croce: 152mm
Profondità: 180mm



SET DI 19 ESTRATTORI DI TERMINALI

| | | | |
|---------------|------|----|------------------|
| 53391 | 0,55 | 10 | 19 PCS |
| 64,50€ | Kg | | |



A, B, C, D, E, F, G, H, I, J, K, L, A1, B2, C3, D4, E5, F6, G7

SET DI 23 ESTRATTORI DI TERMINALI

| | | | | |
|----------------|------|---|-----|------------------|
| 53393 | 1,60 | 5 | 110 | 23 PCS |
| 108,50€ | Kg | | | |



BMW, Audi, Volkswagen, Mercedes, Opel, Porsche, Jaguar, Saab, Seat, Ford, Skoda, Renault, Citroën, Chrysler, Fiat, Honda, Mazda, Mitsubishi, Toyota.

KIT DI ACCESSORI PER L'ESTRAZIONE DI IMPIANTI AUDIO

| | | | | |
|---------------|-----|----|-----|-------|
| 51126 | 0,2 | 10 | 100 | 1.320 |
| 21,00€ | Kg | | | |



Blaupunkt, Peugeot, Clarion, Skoda, Alpine, BMW, Opel, Audi, Grundig VDO, JVC, Pioneer, Volkswagen, Mercedes, Porsche, Renault, Becker.

ESTRATTORE DI SILENT BLOCK PER VAG

| | | | |
|---------------|------|---|----|
| 52270 | 3,18 | 4 | 96 |
| 98,00€ | Kg | | |



Contenuto:
Barra filettata con dado
M10x1.25 spinta.
Testa in acciaio al carbonio

Adapter. Separatore. Thrust.
Centraggio lega di alluminio
mandrino

KIT BUSSOLE DENTI ESTERNI

| | | | |
|----------------|------|---|-------|
| 52834 | 3,73 | 5 | 1.500 |
| 214,00€ | Kg | | |

1/2"

Set di bussole per l'estrazione di noci spline in veicoli industriali.

| | |
|--------|--------|
| 22x3 | 50x5,5 |
| 26x3,5 | 56x5,5 |
| 30x4 | 63x6 |
| 33x4 | 69x6,5 |
| 37x4,5 | 75x6,5 |
| 44x5 | |



SET DI 52 PEZZI PER L'ESTRAZIONE DI APPARECCHIATURE AUDIO

| | | | | |
|---------------|-----|---|-----|-------------------|
| 53388 | 1,5 | 5 | 120 | 52 PCS |
| 88,50€ | Kg | | | |



Blaupunkt, Clarion, Skoda, BMW, Audi, Grundig, JVC, Pioneer, Volkswagen, Mercedes, Opel Doppel-Kugel-Inbus, Porsche, Becker, Kenwood, Sony, Panasonic, Fiat Brava, Ford.

ESTRATTORE SILENT BLOCK POSTERIORE PER VAG

| | | | |
|---------------|------|---|-----|
| 52432 | 1,32 | 5 | 300 |
| 31,00€ | Kg | | |

Per modello utile VW POLO 2002
Facile cambiare le bocche in gomma
sull'asse anteriore

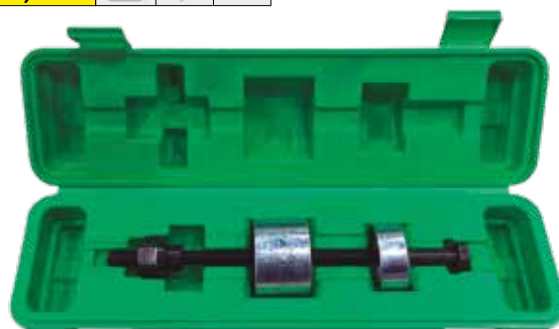

KIT BUSSOLE DENTI INTERNI

| | | | |
|----------------|-----|---|-------|
| 52835 | 5,2 | 3 | 1.500 |
| 233,50€ | Kg | | |

1/2"

Set di bussole per l'estrazione di noci spline in veicoli industriali.

| |
|------------|
| 26x5,3 |
| 1,2x6,25 |
| 34,2x6,3 |
| 38,2x6,65 |
| 42,2x7,3 |
| 50,1x8,25 |
| 58,2x9,8 |
| 74,6x11,9 |
| 82,2x13,25 |
| 87,7x13 |



KIT ESTRATTORE SILENTBLOCK

52494

208,00€

18,55

1

36



Utile per installare e disinstallare bocche e sospensioni. Contiene manicotti di diverse dimensioni e aste filettate di diverse misure.

Misure: M10, M12, M14, M16, M18

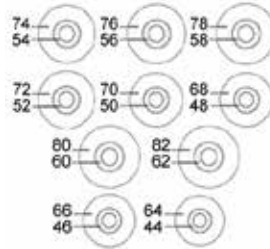

12926 **19,50€** M10

12927 **20,50€** M12

12928 **21,50€** M14

12929 **23,00€** M16

12930 **24,50€** M18

KIT DI MONTAGGIO PER CUSCINETTI

53058

169,50€

8,19

1

102

220mm

Ø 12mm

Ø 18, 19, 20, 21, 22, 23, 24, 25, 26, 27, 28, 29, 30, 31, 32, 33, 34, 35, 36, 37, 38, 39, 40, 41, 42, 43, 44, 45, 46, 47, 48, 49, 50, 51, 52, 53, 54, 55, 56, 57, 58, 59, 60, 61, 62, 63, 64, 65, 74mm



KIT PER L'ESTRAZIONE E INSTALLAZIONE DI CUSCINETTI

53056

109,00€

8,33

2

68



Ø 55.5, 59, 62, 65, 66, 71.5, 73, 78, 84mm

Ø 75.5, 83mm

295mm Ø 69mm

KIT PER L'INSTALLAZIONE DI CUSCINETTI

51349

30,50€

1

10

315

Adattatori di manutenzione per dado striato. Per ogni tipo di mozzo e cuscinetto.

Misure: da 10mm a 42mm.

42 - 38mm
40 - 35mm
36 - 32mm
30 - 28mm
24 - 22mm
27 - 25mm
18 - 16mm



KIT PER L'INSTALLAZIONE DI CUSCINETTI E ANELLI ELASTICI DI SICUREZZA

53059

46,50€

1,56

5

10

240

Ø
39.5, 44.5, 50, 59, 63, 65, 72, 76, 81mm



KIT PER L'INSTALLAZIONE DI CUSCINETTI

| | | | |
|----------------|-------|---|----|
| 52551 | 10,42 | 2 | 70 |
| 142,00€ | Kg | | |

Alberi di trasmissione: 32 e 38mm
 Dimensioni dei Dischi: 50, 55, 60, 64, 67, 70, 72, 74, 75, 78, 82, 84 e 88mm
 Vite heavy-duty per l'utilizzo con gli strumenti di impatto.
 Questo kit riduce la probabilità di danni al mozzo e cuscinetto.
 Albero in acciaio fosfato è progettato per impedire la corrosione.



SET DI ESTRATTORI PER TERGICRISTALLI

53463
94,00€

| | |
|--|------|
| | 1,65 |
| | 10 |
| | 180 |

VW: Polo, Lupo, Touareg, Porsche Cheyenne
Opel: Astra G, Zaphira B, Corsa C, Vectra C
Honda: Jazz, CRV, FRV, Accord, Turnier
BMW: Ser Modell ab E 39 bis Baujahr 05. 7er Modell ab E 38 bis Baujahr 05
Audi: A3, A4, A5, A6. Audi Q7
Ford: Galaxy, Alhambra
Mercedes: A-Class, B-Class

Progettato con gambe fine e estremità sottili in ottone per evitare qualsiasi tipo di danni al carrozzeria, alla vernice o al vetro.
 Applicabile alla maggior parte dei veicoli sul mercato.
 La sua manipolazione consente una rimozione sicura del tergicristallo evitando danni al braccio.



N

ESTRATTORE BRACCIO TERGICRISTALLO

| | | | | |
|---------------|-----|----|----|-----|
| 52454 | 0,2 | 12 | 36 | 576 |
| 20,00€ | Kg | | | |

Ø Max: 45mm
 Ø Min: 17mm



ESTRATTORE DI GIUNTI OMOCINETICI

| | | | |
|---------------|----|---|-----|
| 51364 | 2 | 5 | 280 |
| 31,00€ | Kg | | |

Ø Max: 31mm

140 - 240mm



SET DI 3 BUSSOLE PENTAGONALI

| | | | | |
|---------------|------|----|----|-----|
| 51996 | 0,40 | 10 | 40 | 960 |
| 13,00€ | Kg | | | |



14, 19mm
 10mm



ESTRATTORE FILETTATO PER PULEGGIA DELL'ALBERO MOTORE

| | | | |
|---------------|------|----|-----|
| 51140 | 1,02 | 24 | 290 |
| 69,00€ | Kg | | |

Creato per mantenere immobile la puleggia dell'albero a camme mentre lo si allenta.
 Permette la regolazione dell'asse centrale quando si uniscono. Impiegare il perno filettato centrale per estrarre la puleggia.
 Viti di fissaggio; M6, M8.



INSTALLATORE REGOLABILE DI CUSCINETTI 18-90MM

| | |
|---------------|------|
| 53129 | 0,96 |
| 62,00€ | Kg |
| | 2 |
| | 10 |
| | 180 |

18-90mm



ESTRATTORE DI MOZZI CON GRAFFA SPECIALE A 4 / 5 FORI

| | | | |
|----------------|------|---|-----|
| 51231 | 3,85 | 4 | 295 |
| 179,00€ | Kg | | |

Ø x4

| | | | |
|----------------|------|---|-----|
| 51138 | 3,95 | 4 | 296 |
| 179,00€ | Kg | | |

Ø x5

Questo estrattore include rondelle coniche di estrazione. P.C.D. range 96-126 mm



DISASSEMBLATORE DI TUBI DI SCARICO

| | | | |
|---------------|------|---|-----|
| 51999 | 4,93 | 4 | 120 |
| 83,50€ | Kg | | |

Apertura: Min. 50mm Max. 70mm
 Corsa di aggancio: 170mm
 Contiene 4 adattatori striati



KIT ESPANSIONE DI TUBI DI SCARICO

| | | | |
|---------------|----|------|--|
| 52637 | | | |
| 44,50€ | Kg | 3,01 | |
| | | 5 | |
| | | 220 | |

1-1/8" - 1-3/4"
 1-1/2" - 2-1/2"
 2-1/8" - 3-1/2"



SET DI 3 LEVE INDICIZATE

| | | | |
|---------------|------|----|-----|
| 51990 | 1,83 | 10 | 320 |
| 94,50€ | Kg | | |

Leva da 19,5, 24, 32 cm
 Lunghezza gancio: 6 cm
 Larghezza gancio: 1,5 cm
 Angolo di rotazione: da 0° a 230°



STRUMENTO PER TUBI DI SCARICO

| | | | |
|---------------|------|----|-------|
| 52947 | 0,44 | 36 | 1.008 |
| 18,00€ | Kg | | |

Lunghezza: 6" (150mm)
 Usare con 17 millimetri chiave inglese.
 Distanza minima: 45mm (O.D)
 Distanza massima: 80mm (O.D)
 Applicazioni: VW, Audi, Golf, Jetta, Passat



Essenziale per la rimozione sicura dei morsetti connessi al collettore di scarico. Rimuove e sostituisce il collettore di scarico morsetto a molla su primi modelli Volkswagen dotati di motori 4 cilindri raffreddati ad acqua.

SET DI 2 GANCIO PER LEVARE LE GOMME NEL TUBO DI SCARICO

| | | | | |
|--------------|------|----|----|-----|
| 52849 | 0,22 | 10 | 40 | 480 |
| 7,00€ | Kg | | | |

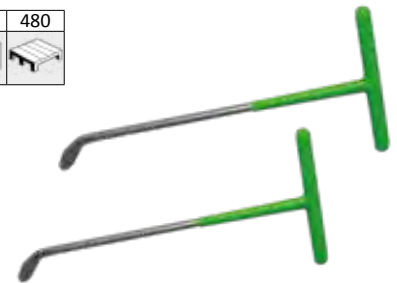

CHIAVE DINAMOMETRICA CON INCAVO

| | | | |
|----------------|------|----|-----|
| 53081 | 1,08 | 25 | 200 |
| 108,00€ | Kg | | |

1/4" 4-20NM (36T)

| | | | |
|----------------|------|----|-----|
| 53082 | 1,85 | 12 | 204 |
| 128,00€ | Kg | | |

1/2" 40-210NM (24T)



Includono il certificato di calibrazione di fabbrica.

CHIAVE DINAMOMETRICA CON TESTA INTERCAMBIABILE 200 NM

| | | | |
|----------------|------|---|-----|
| 52913 | 3,94 | 4 | 128 |
| 300,00€ | Kg | | |

1/2" Includono il certificato di calibrazione di fabbrica.



Max. coppia: serraggio: 40-200Nm

Testine incluse:

Chiavi: 13, 14, 15, 17, 19, 22, 24, 27, 30mm

Cricchetto testa 1/2"

Teste diverse disponibili separatamente.

CHIAVE DINAMOMETRICA

Includono il certificato di calibrazione di fabbrica.

| | | | | | | | |
|------------------------|------------|----------|----------|-----------|-------------------------------|------|-------|
| 51262 44,00€ | 0,83 Kg | 4 Sub | 16 ff | 384 ff | 2-24 Nm 0.2 - 21.4 M. Kg | 1/4" | 270mm |
| 51338 45,50€ | 1,09 Kg | 4 Sub | 16 ff | 288 ff | 19-110 Nm 1.9 - 11 M. Kg | 3/8" | 365mm |
| 51127 46,50€ | 1,73 Kg | 4 Sub | 8 ff | 240 ff | 28-210 Nm 2.9 - 21.4 M. Kg | 1/2" | 470mm |



| | | | | | | |
|-------------------------|-----------|----------|----------|---------------------------|------|---------|
| 52250 528,00€ | 8,4 Kg | 2 Sub | 48 ff | 140-980 Nm 14 - 100 Kg | 3/4" | 1.230mm |
|-------------------------|-----------|----------|----------|---------------------------|------|---------|

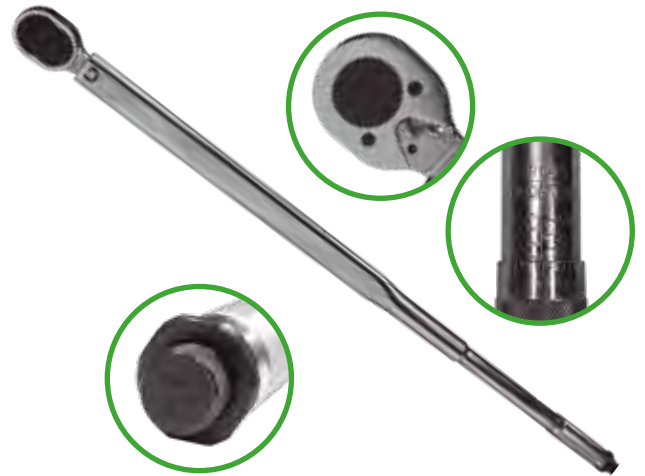

CHIAVE DINAMOMETRICA DIGITALE

| | | | | |
|-------------------------|------------|----------|-----------|------|
| 51828 488,50€ | 2,31 Kg | 6 Sub | 120 ff | 1/2" |
|-------------------------|------------|----------|-----------|------|



UNITÀ DI MISURA:
Gradi
In-Lb
N-m
Ft-Lb

Includono il certificato di calibrazione di fabbrica.

| | |
|------------------------------------|---|
| Esattezza | CW: +/- 2% ccw: +/- 3% |
| Precisione in misurazione in gradi | +/- 2° |
| Raggio d'operazione | 340 N-m / 250,7 ft-lb / 3.009 in-lb / 3.469kg-cm / 999° |
| Risoluzione | 0,1 cN-m / 0,1 ft-lb / 1 in-lb / 1Kg-cm / 1° |
| File delle misurazioni | 9 |
| Led | 2 Led (2 rosso + 10 verde) |
| Operatività | Peak hold / Track |
| Unità di selezione | N-m, in-lb, ft-lb, kg-cm, Gradi |
| Lunghezza | 650mm |
| Denti | 36 |
| Dado | 1/2" |
| Tipo di batteria | AAx2 |
| Batteria di uso continuo | 110h |
| Batteria stand-by | 1 anno |
| Range di temperatura di uso | -10°C ~ 60°C |
| Range di temperatura di stoccaggio | -20°C ~ 70°C |
| Umidità | Fino al 90% senza condensazione |
| Durata | 10.000 cicli |

GIRAVITE DINAMOMETRICO

Includono il certificato di calibrazione di fabbrica.

DIGITAL

| | | |
|-------------------------|------------|----------|
| 51829 429,50€ | 0,65 Kg | 12 ff |
|-------------------------|------------|----------|



MECCANICO

| | | | |
|------------------------|---------|----------|-----------|
| 51830 84,50€ | 1 Kg | 12 ff | 300 ff |
|------------------------|---------|----------|-----------|



| | 51829 | 51830 |
|------------------------------------|---------------------------------|---------------|
| Esattezza | CW: +/- 2,5% ccw: +/- 3,5% | CW: +/- 4% |
| Precisione in misurazione in gradi | +/- 2° | - |
| Raggio d'operazione | 10 ~ 200 cN-m | 2 ~ 10 Nm |
| Raggio d'operazione misto | 40 ~ 200 cN-m | - |
| Risoluzione | 0,1 cN-m / 1 in-lb / 1Kg-cm | - |
| File delle misurazioni | 9 | - |
| Led | 2 Led (1 rosso + 1 verde) | - |
| Unità di selezione | N-m, in-lb, kg-cm | N-m, in-lb |
| Lunghezza | 200mm | 242mm |
| Dado | 1/4" | 1/4" |
| Tipo di batteria | AAAx2 | - |
| Batteria di uso continuo | 110h | - |
| Batteria stand-by | 1 anno | - |
| Range di temperatura di uso | -10°C ~ 60°C | - |
| Range di temperatura di stoccaggio | -20°C ~ 70°C | - |
| Umidità | Fino al 90% senza condensazione | - |
| Durata | 10.000 cicli | 100.000 cicli |

PROFONDIMETRO DIGITALE

| | | | | | | | | |
|------------------------|------------|-----------|-----------|-------------|----------|--------|--------|------------------|
| 53042 12,00€ | 0,06 Kg | 25 Sub | 100 ff | 1.500 ff | 0-25,4mm | 0-40°C | 0,01mm | SR44/LR44 (1.5V) |
|------------------------|------------|-----------|-----------|-------------|----------|--------|--------|------------------|

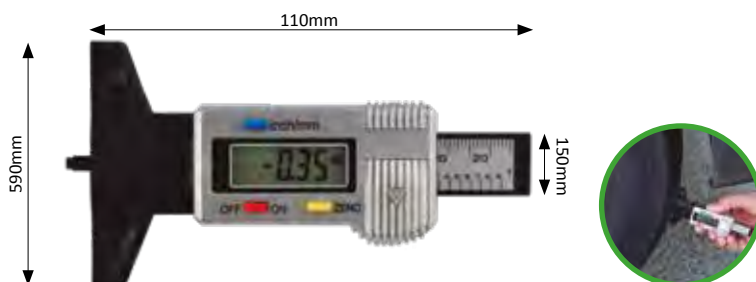

PROFONDIMETRO

| | | | | | |
|------------------------|------------|-----------|-----------|-------------|--------|
| 52873 10,00€ | 0,04 Kg | 50 Sub | 300 ff | 1.500 ff | 0-40mm |
|------------------------|------------|-----------|-----------|-------------|--------|



GONIOMETRO DI 1/2"

52583

10,00€

Kg 0,19

50 4

11 48

11 864



GONIOMETRO 3/4"

52793

78,00€

0,72

6

12

1.500

Kg

50

11

11



Utile per stringere le viti in gradi secondo le specifiche stabilite dai produttori di veicoli e macchinari. Serraggio realizzato mediante cricchetto o chiave dinamometrica da 3/4". Indicatore trasparente per una corretta visione della misura. Range di misura da 0° a 360°.

Chiave a forma di "L" per facilitare il posizionamento dello strumento per una corretta misurazione. Fornito in blister.



CALIBRO A CORSOIO CON SUPPORTO MAGNETICO

52904

48,50€

Kg 2

50 5

11 200



Misura: 0-10mm
Calibrazione: 0,01mm
Diametro: 58mm
Base magnetica: 40kg

13704 **18,00€**

CALIBRO A CORSOIO
PER REF. 52904

GONIOMETRO 1/2" MAGNETICO

52794

32,50€

0,33

6

24

336

Kg

50

11

11



Utile per stringere le viti in gradi secondo le specifiche stabilite dai produttori di veicoli e macchinari. Serraggio realizzato mediante cricchetto o chiave dinamometrica da 1/2".

Indicatore trasparente per una corretta visione della misura. Range di misura da 0° a 360°. Chiave a forma di "L" per faci-

litare il posizionamento dello strumento per una corretta misurazione. Fissaggio del goniometro tramite chiave magnetica per una corretta regolazione prima dell'uso. Il sistema magnetico permette di utilizzare lo strumento in modo rapido sicuro e semplice.



CALIBRO A CORSOIO

50937

10,50€

0,24

10

50

1.500

Kg

50

11

11



50937
MECCANICO

150mm



50724

24,50€

0,24

5

50

900

Kg

50

11

11



50724
DIGITALE

150mm



KIT 20 SPESSIMETRI

52433

6,50€

0,1

10

50

Kg

50

11

0,05 - 1mm



METRO FLESSIBILE

53025

3,50€

Kg 0,13

50 12

11 48

11 1.500

3M
x16mm

53026

5,50€

Kg 0,26

50 12

11 48

11 1.500

5M
x25mm

53027

8,00€

Kg 0,4

50 12

11 48

11 1.500

7,5M
x25mm



MOLTIPLICATORE DI FORZA SNODATO

| | | | |
|---------------|------|----|----|
| 52796 | 8,88 | 3 | 72 |
| 94,00€ | Kg | ft | |

6.000Nm

Ideale per camion con copri bulloni e carter di protezione.

Atto a prevenire danni al cerchio.

Unico nel mercato.

Si adatta a qualsiasi tipo di veicolo

Utile per svitare i dadi bloccati che impediscono la rimozione di ruote o altre strutture.

Include: 1 bussola da 1" 32mm +1 bussola da 1" 33 mm



MOLTIPLICATORE DI FORZA JUNIOR

| | | | |
|---------------|--|--|--|
| 52012 | | | |
| 67,50€ | | | |

| | |
|----|------|
| Kg | 2,34 |
| ft | 4 |
| | 128 |

1/2"



1 moltiplicatore di coppia
1 prolunga a 90°

Bussole di 17 mm, 19 mm e 21 mm

Multiplo in range 1:1:18

Coppia massima d'uscita: 360 Nm

Coppia massima di torsione: 800 Nm

SET DI 8 BUSSOLE PER MOLTIPLICATORE DI FORZA

| | | | |
|---------------|------|----|-----|
| 52056 | 5,50 | 4 | 128 |
| 63,00€ | Kg | ft | |

1"

8
PCS

22, 24, 27, 30, 32,
33, 38, 41mm



► RICAMBI DISPONIBILI

| REF. | mm | Kg | ft | € |
|-------|----|------|----|--------|
| 10672 | 32 | 0,58 | 1 | 18,50€ |
| 10673 | 33 | 0,58 | 1 | 18,50€ |
| 10674 | 27 | 0,54 | 1 | 18,50€ |
| 10675 | 30 | 0,54 | 1 | 18,50€ |



MOLTIPLICATORE A CRICCHETTO DA 3/4"+ RIDUTTORE DA 1/2"

| | | | |
|----------------|------|----|----|
| 51958 | 4,35 | 4 | 96 |
| 374,00€ | Kg | ft | |



Contenuto:

1 moltiplicatore di coppia
1 cricchetto manuale
1 adattatore 1/2" M x 3/4" F
1 kit liberamento
1 prolunga a 90°
1 prolunga da 350 mm

Caratteristiche:

Rapporto di trasmissione 1:4
Rapporto di coppia: 1:3.3
Coppia massima d'entrata: 303Nm
Coppia massima d'uscita: 1000 Nm

MOLTIPLICATORE DI FORZA CON PROLUNGA

| | | | |
|---------------|------|----|-----|
| 51919 | 7,86 | 4 | 120 |
| 64,00€ | Kg | ft | |

Materiale: 40 CR

Potenza massima: 5800Nm

Potenza di lavoro: 3800Nm

Multiplo in range 1:56

Include bussole di 32mm e 33mm da 1"



KIT PER CENTRAGGIO FRIZIONE SAC

| | | | |
|----------------|------|---|----|
| 53001 | 9,69 | 1 | 40 |
| 264,00€ | Kg | | |

Si evitano deformazioni della frizione utilizzando il pretensionatore.

Utilizzando l'utensile di azzeramento si porterà alla nuova posizione l'anello di regolazione della piastra reggispinta quando si monta una nuova valvola della frizione.

Adatto a quasi tutte le frizioni SAC (frizioni a recupero automatico del gioco).

Vantaggi:

Messa in tensione della piastra reggispinta della frizione nel montaggio e smontaggio.

Riposizionamento della molla di regolazione con l'utensile di azzeramento.

Centraggio della valvola rispetto al cuscinetto guida.

Contenuto:

Pretensionatore della frizione

Centratore a 3 fori

Utensile di azzeramento

Kit di perni di centraggio

Centratore a 4 fori

Per:
VW
Audi
Bmw
Mercedes
Volvo
Renault
Opel



CENTRAGGIO DELLA FRIZIONE SAC

| | | | |
|---------------|-----|----|-----|
| 53410 | 1,6 | 10 | 230 |
| 82,50€ | Kg | | |



Diametro di centraggio:
15-19 / 20-26,6 / 23-36 mm

Diametro di accessori:
12, 14, 15, 16, 17, 18, 19, 20 mm

KIT DI RIPARAZIONE DI FRIZIONE DI DOPPIA FACCIA PER LA TRASMISSIONE DSG DE VAG

| | | |
|----------------|------|---|
| 53057 | 6,04 | 2 |
| 169,50€ | Kg | |



Per il servizio di DSG in Golf (2004-), Golf Plus (2005-), AUDI A3 (2004-) con 7 trasmissioni a velocità di codice 0AM, e Touareg (2003-) con 6 velocità codice di trasmissione 08D.
Riferimenti: OEM T10323, T10373, T10374.

MANDRINO DI CENTRAGGIO FRIZIONE

| | | |
|---------------|-----|----|
| 53392 | 0,6 | 25 |
| 49,00€ | Kg | |

2
PCS



Ø 20 - 26mm



Ø 15 - 19mm



CENTRAFRIZIONE IN PLASTICA UNIVERSALE

| | | | | |
|---------------|-----|---|----|-----|
| 52495 | 0,2 | 4 | 48 | 864 |
| 21,00€ | Kg | | | |

Per la maggior parte dei modelli in commercio.
Include 3 adattatori di diverso diametro.



TESTER DELLA PRESSIONE SISTEMA DI RAFFREDDAMENTO

52687

185,00€

| | |
|--|------|
| | 5,72 |
| | 3 |
| | 30 |

Range 0 -2,5 bar
19 testine di stampa controllo radiatori specifici
1 testa di controllo radiatori universale



- 1: Pompe a pressione con valvola di scarico
2A: connettore 1: accoppiamento per i testine No.3(R123) e No.4 (R124)
2B: connettore 2: accoppiamento per i testina No. 3(R123) e No. 5(R125)
3: Mercedes (W123, W126, W124, W201), GM(Buick), Jeep 4: Peugeot, Subaru, Chrysler, Acura, GM (Nova, Spectrum, Sprint), Mitsubishi, Nissan, Mazda, Toyota, Infiniti, GEO, Suzuki, Isuzu, Mercedes
5: Honda, Toyota, Suzuki, Mitsubishi, Chrysler, Acura 6: Mercedes Benz (ML, W163, W164), GM (Achiva, Skylark, Grand Am 1992~2002)
7: Volvo, Saab, Sterling, Citroen, Renault, Fiat, Alfa, Jeep
8: VW(Vento, T4, Passat-1996, Golf, Beetle, Sharan)

- 9: Audi(A4, A5, A6), BMW 345, VW(Passat-1997~2002), Porsche(Cayenne)
10: BMW (E46, E36, E34, E39, E38, E32, E90)
11: Audi, VW
12: Internazionale, Land Rover, Jaguar
13: Mercedes (C, E, S, W140, W220, W124, W210, W211, W215, W216, W221, R230)
14: Ford Focus
15: Mazda(M3)
16: Mercedes classe A (W168)
17: BMW E60, E63, E64, E65
18: VW SHARAN 1.8T 2.8
19: TOYOTA-RAV4, PREVIA adattatore di gomma universale per lo spurgo e riempimento radiatori
20: SAAB
21: LAND ROVER

TESTER DELLA PRESSIONE SISTEMA DI RAFFREDDAMENTO

51339

284,00€

| | |
|--|------|
| | 5,24 |
| | 3 |
| | 30 |

Adattatore da 2,3"
Adattatore da 4,5"
Pompa del sistema di raffreddamento
Guarnizione a forma di "T"
da 5/16" - 3/8"
Tubo dell'olio da 5/16", 3/8"
2 fascette



- N. 1 GM, 4 cilindri (Buick, Chevrolet, Pontiac, Cadillac)
N. 2 Carrello
N. 3 Mercedes-Benz, Ford, Chrysler, GM, Jeep, Peugeot
N. 4 Acura, Dodge, Eagle, Geo, Honda, Isuzu, Lexus, Mazda, Mitsubishi, Suzuki, Toyota, Nissan, GM, Peugeot, Ford, Chrysler
N. 5 Toyota, Honda, Mitsubishi, Suzuki, Lexus, Chrysler, Acura, Dodge
N. 6 Buick, Chevrolet, Ford, Lincoln, GM, Opel, VW, Saab, Benz (clase ML) Jaguar, Rover

- N. 7 Jeep, Renault, Saab, Volvo, Audi, Citroën, Fiat, Peugeot, Alfa
N. 8 VW
N. 9 Audi (A4, A6, A8) VW (Passat 1997-2002, Golf, Jetta)
N.10 BMW
N.11 VW, Audi
N.12 Ford, GM, Rover, Opel, Jaguar, BMW 245
N.13 Mercedes-Benz Sedane
N.14 Saab, Opel

KIT LOCALIZZAZIONE FUGA AA/CC

52844

1,08 10 120

76,00€

| | |
|--|------|
| | 1,08 |
| | 10 |
| | 120 |



Appositamente progettate per rilevare le perdite di pressione nel sistema di condizionamento e refrigerazione. Consiste nell'inserire un liquido fluorescente neutro nel circuito per rilevare la perdita rapidamente.

Contenuto:
1 x Lampada UV
1 x Occhiali per la visione UV
3 x Pile "AAA"
1 x Siringa inserimento fluido
1 x Quick adattatore
1 x Adattatore di estensione

LIQUIDO PER IL RILEVAMENTO DI FUGHE

12977

0,33 3 12 384

32,00€

| | |
|--|------|
| | 0,33 |
| | 3 |
| | 12 |
| | 384 |

250ml

Un'applicazione di 7,5 ml per ogni 1.4L refrigerante



SET ATTREZZI PER SISTEMA DI CONDIZIONAMENTO D'ARIA

53457

23,50€

| | |
|--|------|
| | 0,35 |
| | 10 |
| | 20 |

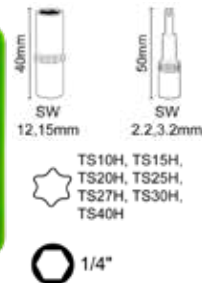
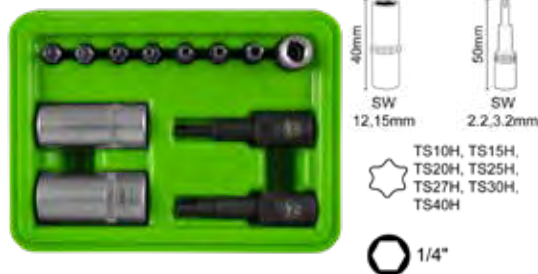

ATTREZZO PER STACCO DI SISTEMA DI CONDIZIONAMENTO D'ARIA

53459

66,50€

| | |
|--|------|
| | 1,05 |
| | 10 |
| | 180 |



ATTREZZO PER STACCO DI SISTEMA DI CONDIZIONAMENTO D'ARIA

53458

0,1 12 72

4,00€

| | |
|--|-----|
| | 0,1 |
| | 12 |
| | 72 |



SET DI STRUMENTI DIAGNOSTICI PER IMPIANTO DI CONDIZIONAMENTO

| | | | |
|---------------|-----|-----|----|
| 53456 | 2,8 | 5 | 75 |
| 90,00€ | Kg | sub | ff |

BAR

Test di deviazione verso la pressione alta e bassa degli impianti di condizionamento dell'auto.

Struttura in alluminio leggera del blocco, con un vetro di ispezione e i manometri grandi facilmente leggibili antivibrazione.

Diramazioni professionali (con la codificazione e marcatura a colori). Tre tubi flessibili di carica di colore e un gancio per appendere, senza usare le mani.

Applicazione: R134a, R12

Lunghezza del tubo flessibile: 1550mm



TORCIA A UV LED PORTATILE

| | | | | |
|---------------|------|-----|----|-----|
| 53451 | 0,35 | 10 | 40 | 480 |
| 40,00€ | Kg | sub | ff | ff |

UV

UV LED

| | |
|-------|---------------------|
| 3-4H | 9/36H |
| IP 44 | Li-Ion 3.7V 2000MAH |
| LED | 11 LED |
| 390mm | 70mm |
| 50mm | |



LAMPADA PORTATILE COB ULTRAVIOLETTA FLESSIBILE CON BASE MAGNETICA

N

| | | | | |
|---------------|-----|-----|----|-----|
| 53530 | 0,3 | 5 | 20 | 620 |
| 43,00€ | Kg | sub | ff | ff |

UV

380mm
45mm

| | |
|---------|--------------|
| 200 Lm | LED |
| 5V | 2W COB |
| 1.000MA | 3.7V 2600MAH |
| 4H | 4H |



UV LED

ADATTATORE PER LA CARICA DAL GAS 1234YF

N

| | | | |
|---------------|-----|-----|----|
| 53499 | 0,2 | 15 | 60 |
| 28,00€ | Kg | sub | ff |

| | |
|---------|--|
| R1234YF | |
|---------|--|



| | | | |
|---------------|-----|-----|----|
| 53500 | 0,2 | 15 | 60 |
| 28,00€ | Kg | sub | ff |

| | |
|---------|--|
| R1234YF | |
|---------|--|



SET DI RIEMPIMENTO DI OLIO, IMBUTO E ADATTATORI

53485
122,50€

3 4 40
Kg ft

15
PCS

N

- Subaru (M42x4.5)
- Lexus, Pontiac, Scion, Toyota (M37x3.0)
- Ford, Jaguar, Land Rover, Mazda (M35x4.0)
- Acura, Dodge, Ford, Honda, Jaguar, Jeep, Land Rover, Mazda, Nissan, Acura (M32x3.5)
- Audi, BMW, Mercedes, Porsche, Volvo, VW
- Toyota, Lexus, Scion, Pontiac
- Dodge (M30x3.0)
- Mazda (1/2" Turn)
- Cadillac, Chevy, Ford, GMC, Hyundai, Jaguar, Land Rover, Mazda, Mercury, Saab (1/2" Turn)
- Audi, VW, Skoda (1/4" Turn)
- Dodge (1/2" Turn)
- Lexus, Pontiac, Scion, Toyota (M37x3.0)



53347
93,00€

2,75 4 36
Kg ft

8
PCS



- Subaru
- Dodge - Honda Acura - Nissan Jaguar - Ford M32x3,5
- Mazda M35x4,0
- Subaru M42x4,5
- VW - Audi BMW - Porsche Mercedes - Volvo
- Toyota - Lexus Scion - Pontiac M37x3,0

POMPA PER IL CONTROLLO DELLA PRESSIONE E VUOTO DEI CIRCUITI

51822
136,50€

1,9 6 84
Kg ft

Questo kit include, assieme alla pompa a vuoto, un set completo di inserti, adattatori, tappi, gomme e misurino per un corretto e facile spurgo del sistema frenante e per un agevole controllo dello stesso.



KIT RIPARATORE DEI SENSORI DI OSSIGENO

52294
79,00€

0,85
Kg ft

10
PCS



- 1 vite in utensili per inserire L - 80MM M18X1.5
- 5 filetto con collana L = 9MM IG = M18X1.5 / AG = M20X1.5
- 1 spergliatore M18X1.5 - 50MM
- 1 Filetto M18X1.5 - 50MM
- 1 Filetto M20X1.5 - 50MM

KIT SMONTAGGIO AMMORTIZZATORI

53118
228,00€

6,66 3 42
Kg ft

39
PCS

CrV 6140
CrMo SCM415
CrV 50BV30



COMPROVATORE ANGOLARE DI CADUTA MAGNETIZZATO

52318
64,50€

0,64
Kg ft

24
ft

336
ft

-6°/+6°



PREMIMOLLA AMMORTIZZATORE

50827

301,50€

32,45

1

18

350 x 350 x 1.100mm



Ø massimo della molla: 190mm
Altezza massima della molla: 490mm
300Psi

CE

KIT PREMIMOLLE PER VALVOLE

51120

42,00€

2,42

5

10

160



Valido per auto e per moto.

15 adattatori permettono il celere e facile inserimento del premimolle per valvole.



Contenuto:
Premimolle
Adattatori:
30, 25, 23, 19, 16mm

KIT PREMIMOLLA AMMORTIZZATORE

51121

26,50€

1,72

4

8

416

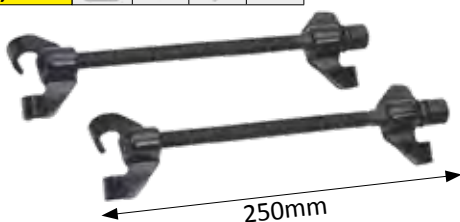

Artigli e vite forgiati in lega ferro-carbonio, temperati per garantirne una qualità professionale. Utensile specialmente creato per l'uso in spazi limitati e sotto il passaruota, che offre la massima protezione.
Apertura massima: 250 mm

COMPRESSORE DELLA MOLLA

53394

571,50€

29,7

1

18



Kit professionale che consente di rimuovere e installare rapidamente le sospensioni anteriori e posteriori senza rimuovere l'assale.



Braccio telescopico e superfici antiscivolo che consentono una presa solida delle molle.
Artigli dotati di una protezione in plastica intercambiabile per evitare di danneggiare la vernice della molla.
Impedisce che le molle si pieghino in compressione.
Universale, copre il 90% della flotta di veicoli.
Può essere utilizzato sia per molle diritte che coniche.
Contenuti:
Dispositivo / pistone.
Tre paia di mascelle con coperture in plastica.

COMPRESSORE DI MOLLA PROFESSIONALE Mc PHERSON

52227

273,00€

15,1

1

24

Bmw, Toyota, Ford, Mitsubishi, VW, Audi, Saab, Nissan, Honda Accord, Subaru, Volvo, Opel, Porsche

NON UTILIZZARE CON LA PISTOLA PNEUMATICA



Specifiche tecniche:
Carico massimo: 2500N
Un corpo principale
Un sostegno esteso

3 paia di mascelle
Paio 1: Gamma di uso: 80-115mm. Peso: 1.45kg
Paio 2: Gamma di uso: 110-195mm. Peso: 2.2kg
Paio 3: Gamma di uso: 140-195mm. Peso: 2.3kg

KIT PREMIMOLLE PER VALVOLE 45-145MM

52734

42,00€

2,61

10

175

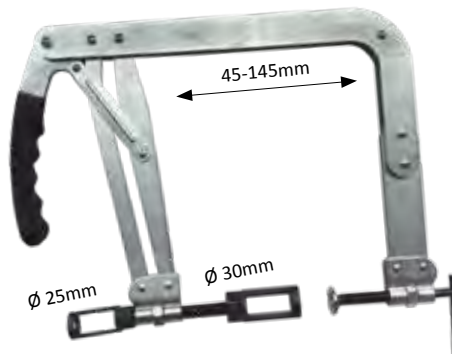

ATTREZZO PER REGOLAZIONE DELLA CAMPANATURA (VAG)

N

| | | | |
|---------------|------|---|-----|
| 53488 | 2,75 | 5 | 200 |
| 54,50€ | | | |



Include:

- Mandrino esagonale da 22 mm
- 3 lunghezze diverse:
- 75mm: Seat-Toledo / VW-Jeta / Golg
- 85mm: Seat-Cordoba / VW-Polo / 95 >
- 115mm: Chrysler-Voyager

Permette a una singola persona di regolare l'angolo di caduta della ruota.



PINZA PER AFFERRARE BATTERIA

| | | | |
|---------------|------|--|--|
| 52613 | | | |
| 17,00€ | | | |
| | 0,57 | | |
| | 8 | | |
| | 360 | | |



KIT PER LA PULIZIA DEI TERMINALI DI BATTERIA

| | | | | |
|--------------|------|----|----|-----|
| 52319 | 0,16 | 12 | 72 | 720 |
| 9,50€ | | | | |



| | | | | |
|--------------|------|----|----|-----|
| 52621 | 0,14 | 10 | 40 | 800 |
| 8,00€ | | | | |



KIT PREMIMOLLE PER VALVOLE

| | | | | |
|---------------|------|---|----|-----|
| 52693 | 0,82 | 5 | 25 | 450 |
| 40,50€ | | | | |

Usò per OHV, OHC, CHV.
Sostituire le molle e guarnizioni valvole montate alla testata.
Possibilità di comprimere e rimuovere.
Con artiglio / adattatore e il blocco reversibile posizione predeterminata.



VALIGETTA CON 38 SPAZZOLE METALLICHE

| | | | |
|---------------|------|----|-----|
| 51989 | 1,64 | 10 | 120 |
| 45,00€ | | | |

38 PCS

Ø 8, 9, 10, 11, 12, 13, 14, 15, 16, 17, 18, 19mm

1 Manico da 1/4", 1 prolunga, 36 spazzole.



KIT DI SMONTAGGIO E RIVETTAZIONE DI CATENA DI MOTOCICLETTA

| | | | |
|---------------|------|----|-----|
| 53055 | 0,89 | 10 | 600 |
| 32,00€ | | | |



SET 3 SPAZZOLE METALLICHE

| | | | | |
|---------------|------|----|----|-----|
| 52515 | 0,15 | 12 | 72 | 800 |
| 10,50€ | | | | |

225mm



1 x Ottone
1 x Nylon
1 x Acciaio

SPAZZOLE METALLICHE

| | | | |
|--------------|--|--|--|
| 52760 | | | |
| 5,00€ | | | |

| | |
|--|-------|
| | 0,09 |
| | 12 |
| | 120 |
| | 2.160 |



STRUMENTI SPECIALI

CHIAVE SERBATOIO MITTENTE

53096

42,00€

Kg 1

5

10

320

89-170mm

HEX 15mm



COMPRESSORE PER ANELLO PISTONE

52757

20,00€

0,55 10 20 360

Kg **5** **10** **360**



Min: 80mm
Max: 160mm



CHIAVE PER MOTOCICLETTE

53086

10,00€

0,18 12 72 1.500

Kg **5** **10** **1.500**

3/8"



17, 19, 22, 24mm



Yamaha, Kawasaki,
BMW, Suzuki, Honda

CHIAVI A BUSSOLA SPECIALE PER MOTOCICLETTE

53054

4,00€

0,16 12 72 1.500

Kg **5** **10** **1.500**



LEVIGATORE PER CILINDRI

2 BRACCI

52591

13,50€

Kg 0,10

50

100

200

Min: 19mm
Max: 55mm

28,6mm

1-1/8"



3 BRACCI

52592

21,00€

Kg 0,14

50

100

480

Min: 35mm
Max: 85mm

50,8mm

2"



3 BRACCI

52593

34,50€

Kg 0,47

5

20

320

Min: 55mm
Max: 170mm

101,6mm

4"



RICAMBI LUCIDATURA 1-1/8"
IN BLISTER 3 UNITÀ
PER REF.52591

11878

5,00€



RICAMBI LUCIDATURA 2"
IN BLISTER 3 UNITÀ
PER REF.52592

11879

5,50€



RICAMBI LUCIDATURA 4"
IN BLISTER 3 UNITÀ
PER REF.52593

11880

10,00€



KIT PER COMPRIMERE ANELLI DEL PISTONE

53251

89,00€

2,80

4

72

Kg

5

10



Set completo di anelli e fasce elastiche.
Tenaglie o pinza per installare segmenti
di pistoni.

Il rafforzamento delle guaine ha un
sistema a cricchetto dentato.



H:3"
Ø 53-125mm

H:4"
Ø 60-175mm

H:6"
Ø 60-175mm

COMPRESSORE PER ANELLO PISTONE

52696

7,50€

0,29 5 40 1.280

Kg **5** **10** **1.280**

Ø 53 /175mm

3"

52697

11,00€

0,55 5 40 480

Kg **5** **10** **480**

Ø 60 /175mm

6"

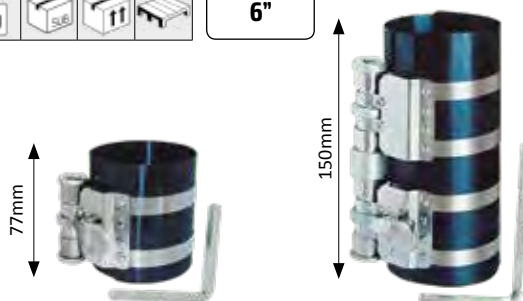

52696

52697

PISTOLA STROBOSCOPICA

Regolare i motori ad accensione.

DIGITALE

| | | | | | | | |
|---------------|------|----|-----|------|------|------|-------|
| 53474 | 0,85 | 20 | 160 | 12V | 1.8m | 0.1° | 9.000 |
| 71,50€ | Kg | ft | ft | 3,6W | | | |

N



2 PINZE



SENSORE INDUTTIVO

| | | | | | |
|---------------|------|----|-----|------|------|
| 53240 | 0,75 | 20 | 160 | 12V | 1.5m |
| 41,50€ | Kg | ft | ft | 3,6W | |



2 PINZE



SENSORE INDUTTIVO

KIT STETOSCOPIO DI CONTROLLO

| | | | |
|----------------|------|----|----|
| 53249 | 2,85 | 5 | 50 |
| 177,50€ | Kg | ft | ft |



Kit idoneo alla rilevazione guasti nei collettori di aspirazione / scarico, iniettori, radiatori ecc. Consente il monitoraggio simultaneo di più punti del veicolo facilitando il compito dell'operatore nel trovare e diagnosticare i guasti. Sonde a colori che rendono l'operazione facile per l'operatore. Include il fissaggio a velcro per i sensori.

Caratteristiche:

- Lunghezza del cavo sensore: 4,8 m
- Lunghezza della sonda audio: 14 cm
- Batterie 9V (include)
- Numero di sensori: 6
- Adatto per connettore da 3,5 mm
- Lunghezza del microfono regolabile: 21cm

STETOSCOPIO

| | | | | |
|---------------|------|----|----|-----|
| 51347 | 0,15 | 5 | 50 | 300 |
| 10,00€ | Kg | ft | ft | ft |

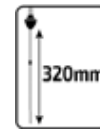

Amplifica e localizza rumori meccanici interni e di passaggio di fluidi. Localizza rapidamente la sorgente di rumore del motore. Permette di localizzare razionalmente i problemi nel flusso di acqua, benzina, gas o vapore. Manico antiurto.

PUNZONI LETTERE E NUMERI

| | | | | | | | | |
|---------------|------|----|----|-----|--------|-----|-------|-----------|
| 52422 | 0,82 | 5 | 20 | 540 | 36 PCS | 5mm | 3/16" | A-Z & 0-9 |
| 22,00€ | Kg | ft | ft | ft | | | | |
| 53119 | 1,94 | 3 | 6 | 504 | 36 PCS | 8mm | 5/16" | A-Z & 0-9 |
| 35,50€ | Kg | ft | ft | ft | | | | |



53119



52422

PUNZONI NUMERI

| | | | | |
|---------------|------|-----|-------|-------|
| 52882 | 0,30 | 75 | 1.500 | 9 PCS |
| 11,00€ | Kg | ft | ft | |
| 6mm | 1/4" | 0-8 | | |



ALTRI UTENSILI

MORSETTO DI BLOCCAGGIO PER PISTONCINI COFANO E BAGAGLIAIO

N

| | | | | |
|---------------|------|-----|----|-----|
| 53525 | 0,08 | 5 | 30 | 300 |
| 12,50€ | Kg | sub | ff | |

 Diametro massimo di apertura: 10 mm



BASTONE ESTENSIBILE MULTIFUNZIONE

| | | | | |
|---------------|------|-----|----|-----|
| 52497 | 0,29 | 6 | 48 | 480 |
| 17,50€ | Kg | sub | ff | |

Min: 53mm
Max: 120mm

| | | | | |
|---------------|-----|-----|----|-----|
| 53196 | 0,3 | 6 | 48 | 576 |
| 18,00€ | Kg | sub | ff | |

Min: 71mm
Max: 160mm



3 SEZIONI
IN ALLUMINIO

FORTE E LEGGERO



Controllare le luci dei freni.
Pressione gomme.
Rimuovere gli oggetti dalla scanalatura degli pneumatici.
Supporto per cappa.

PORTAINSERTI ANGOLARE

| | | | | |
|--------------|------|-----|----|-------|
| 52620 | 0,05 | 6 | 36 | 1.584 |
| 8,00€ | Kg | sub | ff | |

37mm

Trapano 6mm

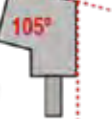

Per zone difficili da raggiungere.
Con la funzione presa rapida.
Estrarre facilmente.

SET DI 8 MORSETTI PER LA DESCONNESSIONE DEI TUBI

N

| | | | |
|---------------|-----|----|-----|
| 53477 | 0,8 | 10 | 220 |
| 33,00€ | Kg | ff | |

8
PCS

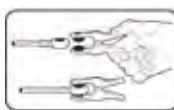
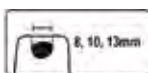

SET DI 3 PINZE PER MANICHETTA FLESSIBILE

| | | | | |
|---------------|------|-----|----|-----|
| 52066 | 0,28 | 5 | 50 | 450 |
| 15,50€ | Kg | sub | ff | |

1/2"

3/4"

5/8"



Ottimo per circuito di freni,
carburante e refrigerante.

 ±0-20mm

 ±0-35mm

 ±0-70mm



| | | | | |
|---------------|-----|-----|----|-----|
| 53395 | 0,3 | 10 | 20 | 360 |
| 15,50€ | Kg | sub | ff | |

Ø 10, 15, 24mm



VASSOIO MAGNETICO FLESSIBILE

| | | | | |
|---------------|------|---|----|-------|
| 52516 | 0,42 | 6 | 24 | 1.152 |
| 24,00€ | Kg | | | |

Ø superiore: 225mm
Ø di base: 88mm
Misure distribuiti: 135mm
Misure pieghevoli: 43mm

| | | | | |
|---------------|------|----|----|-------|
| 52517 | 5,02 | 12 | 72 | 1.152 |
| 10,50€ | Kg | | | |

Ø superiore: 135mm
Ø di base: 53mm
Misure distribuiti: 90mm
Misure pieghevoli: 31mm



Vassoio di plastica con patina magnetica per viti di fissaggio, bulloni e minuteria.

RECIPIENTE MAGNETICO

| | | | | |
|--------------|------|---|----|-----|
| 52466 | 0,43 | 1 | 20 | 180 |
| 8,50€ | Kg | | | |



PLASTICA
ABS

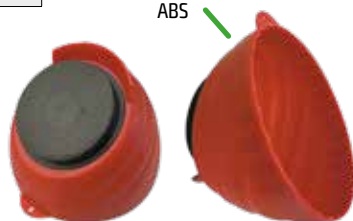

BACINELLA MAGNETIZZATA

| | | | |
|--------------|------|----|-----|
| 50787 | 0,31 | 36 | 648 |
| 5,50€ | Kg | | |

x1 Ø 150mm



| | | | |
|---------------|------|----|-----|
| 50788 | 0,62 | 24 | 432 |
| 11,00€ | Kg | | |

x1 230 x 130mm



DISCHI MAGNETICI

| | | |
|--------------|------|---|
| 52756 | 0,01 | 2 |
| 7,00€ | Kg | |

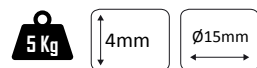

x1

APPENDI ATTREZZATURA MAGNETICO

| | | | |
|--------------|-----|----|-------|
| 52467 | 0,5 | 24 | 1.008 |
| 9,50€ | Kg | | |

Potente magneti con imbottitura per evitare di danneggiare le superfici.

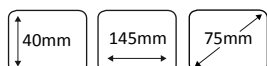

GANCIO MAGNETICO

| | | | | |
|--------------|------|----|----|-----|
| 52378 | 0,36 | 10 | 40 | 720 |
| 9,00€ | Kg | | | |



Ø 6cm



| | | | |
|---------------|------|----|----|
| 51341 | 1,62 | 12 | 96 |
| 33,00€ | Kg | | |



Ø 7cm



SET DI 2 RIPIANI MAGNETIZZATI

| | | | |
|---------------|------|----|----|
| 50790 | 1,17 | 12 | 96 |
| 24,50€ | Kg | | |



21x11,5cm

28x11,5cm

APPENDITORE MAGNETICO

| | | | | |
|---------------|------|----|----|-----|
| 50789 | 0,89 | 10 | 20 | 300 |
| 19,00€ | Kg | | | |

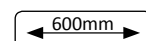



KIT ATTREZZI

| | |
|-------------------------------|-----|
| BMW | 167 |
| MERCEDES | 170 |
| AUDI | 172 |
| VOLKSWAGEN | 172 |
| RENAULT | 177 |
| FORD / MAZDA | 178 |
| JAGUAR / LAND ROVER | 180 |
| OPEL / VAUXHALL | 181 |
| FIAT | 183 |
| ALFA | 184 |
| CITROËN | 186 |
| PEUGEOT | 186 |
| VOLVO | 187 |
| ATTREZZO DI REGOLAZIONE | |
| ALBERO | 188 |
| KITS DI DISTRIBUZIONE . | 189 |
| ALTRI STRUMENTI | 190 |

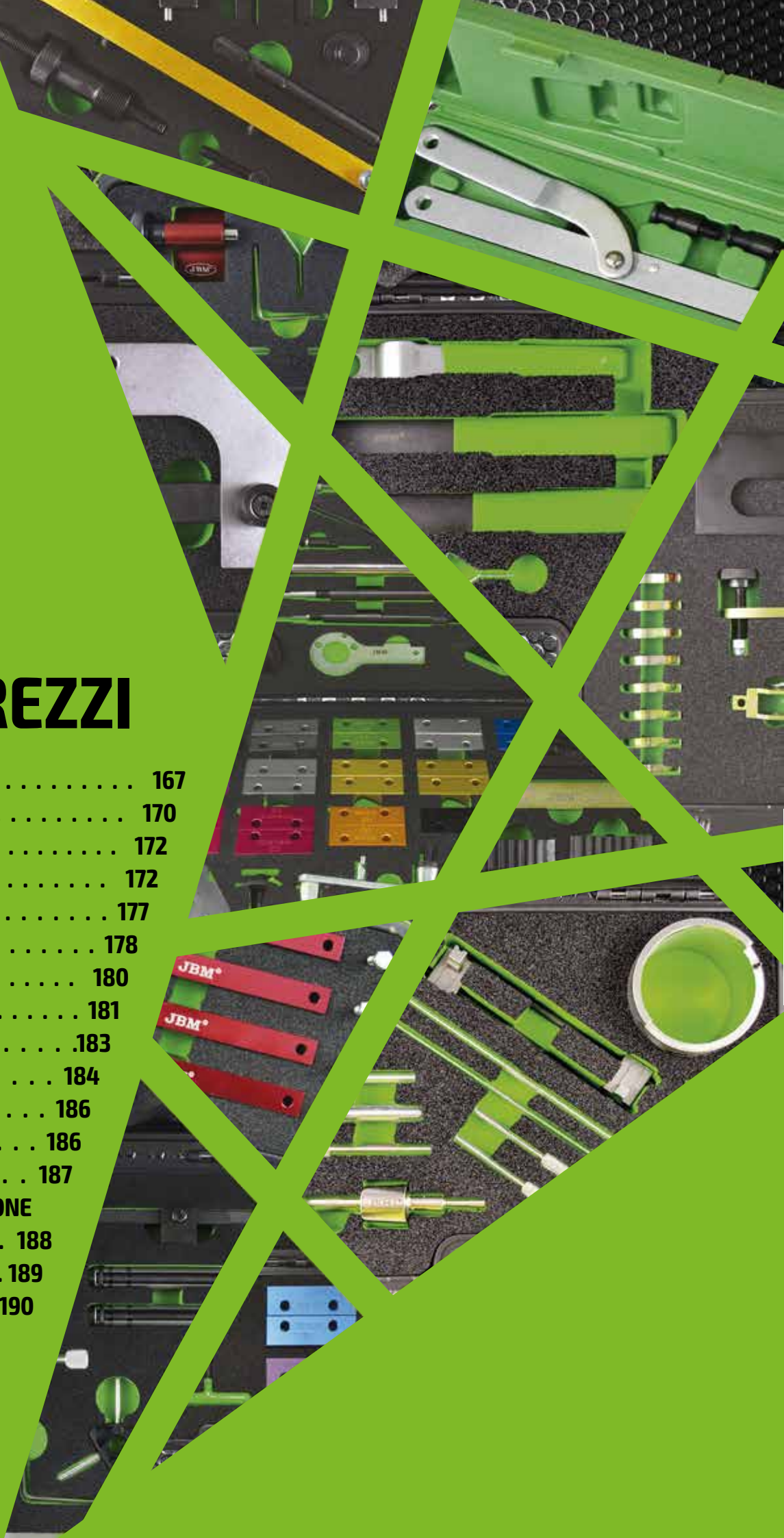



TIMING TOOLS

KIT ATTREZZI



KIT ATTREZZI PER MONTAGGIO/FISSAGGIO MOTORI BMW N42 / N46 1.8 / 2.0 CON TRASMISSIONE A CATENA

| | | | |
|----------------|-----|---|-----|
| 53259 | 2,8 | 5 | 135 |
| 108,00€ | | | |

benzina

| | | |
|----------------------|-----|--|
| MODELLO | BMW | <p>BMW 1 SERIES: 118i E81/82/87/88 (04-14), 120i E81/82/87/88 (04-14).</p> <p>BMW 3 SERIES: 316i/ti Compact E46 (01-07), 318i/ti Compact E46 (01-07), 318i, E90/91/92/93 (05-12), 320i E90/91/92/93 (05-12).</p> <p>BMW 5 SERIES: 520i E60/61 (07-10), Z4 2.0 E85/86 (04-09).</p> <p>BMW X SERIES: X1 sDrive 18i E84 (10-12), X1 xDrive 18i E84 (10-12), X3 2.0 E83 (05-10).</p> |
| UTENSILI OEM | | 11.9.350 (1), 11.9.340 (2), 11.9.291 (3), 11.9.292 (4), 11.9.270 (5), 11.5.120 (6), 11.9.190 (7), 11.9.293 (8) |
| CODICE MOTORE | | 1.8: N42; B18A, N46; B18. / 2.0: N42; B20A, N46; B20, B20B, N46T; B20, B20B, B20BD, B20BZ, B20O2, B20Z. |

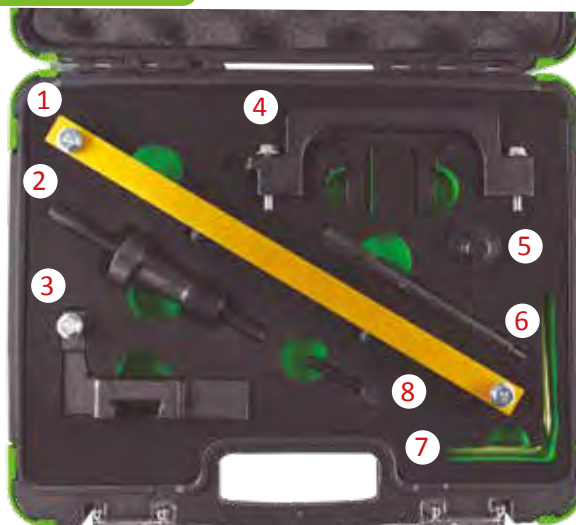

KIT ATTREZZI PER MONTAGGIO/FISSAGGIO MOTORI A BENZINA BMW N42 / N46 1.6 / 1.8 / 2.0 CON TRASMISSIONE A CATENA

| | | | |
|----------------|-----|---|----|
| 53260 | 5,6 | 2 | 40 |
| 239,00€ | | | |

benzina

| | | |
|----------------------|-----|--|
| MODELLO | BMW | <p>BMW 1 SERIES: 116i E81/82/87/88 (07-12), 118i E81/82/87/88 (06-14), 120i E81/82/87/88 (06-14).</p> <p>BMW 3 SERIES: 316i E90/91/92/93 (07-11), 318i E90/91/92/93 (07-13), 320i E90/91/92/93 (07-14).</p> <p>BMW 5 SERIES: 520i E60/61 (07-10).</p> |
| UTENSILI OEM | | 11 8 690 (11 8 691/11 8 692/11 8 693) (1), 11 8 710 (11 8 711/11 8 712) (2), 11 3 340 (3) (4), 11 8 700 (5), 11 9 340 (11 9 341/11 9 342) (6), 11 5 120 (7). |
| CODICE MOTORE | | N43: B16A/AA, B16AA, B16AA/OO, B20A, B20A/AA, B20AA, B20AY, B20KO, B20UO |

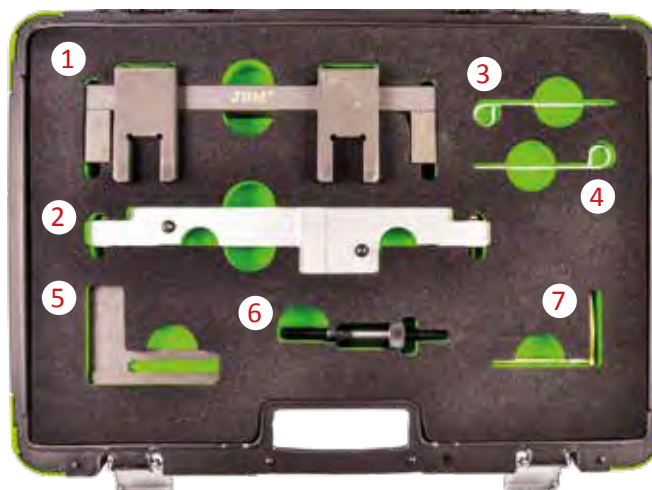

KIT ATTREZZI PER FISSAGGIO BMW N42 / N46

| | | | |
|----------------|-----|---|----|
| 53261 | 5,2 | 2 | 40 |
| 216,00€ | | | |

benzina

| | | |
|----------------------|-----|--|
| MODELLO | BMW | <p>BMW 1 SERIES: 118i E81/82/87/88 (04-14), 120i E81/82/87/88 (04-14).</p> <p>BMW 3 SERIES: 316i/ti Compact E46 (01-07), 318i/ti Compact E46 (01-07), 318i E90/91/92/93 (05-12), 320i (E90/91/92/93 (05-14).</p> <p>BMW 5 SERIES: 520i E60/61 (07-10).</p> <p>BMW X SERIES: X1 E84 sDrive 18i (10-12), X1 E84 xDrive 18i (10-12), X3 E83 2.0 (05-10).</p> <p>BMW Z SERIES: Z4 2.0 E85/86 (04-09).</p> |
| UTENSILI OEM | | 11 9 190 (1), 11 9 310 (2), 11 9 302 (3) |
| CODICE MOTORE | | 2.0: N42 B18A, N42 B20A, N46 B18, N46 B20, N46 B20B, N46T B20, N46T B20B, N46T B20BD, N46T B20BZ, N46T B20O2, N46T B20Z |

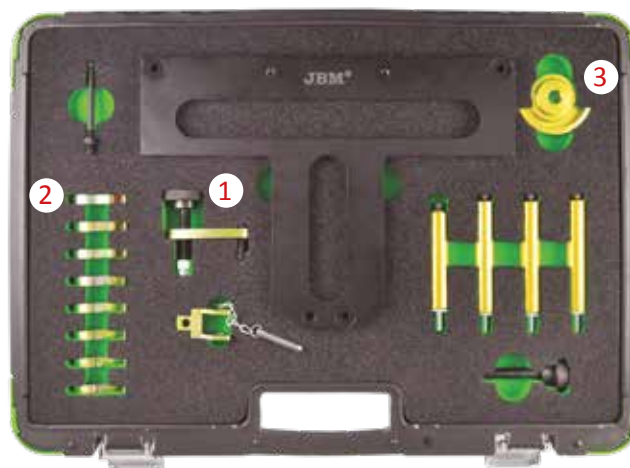

ATTREZZO DI REGOLAZIONE ALBERO A CAMME PER BMW M52TU / M54 / M56 CON SISTEMA DOUBLE VANOS

| | | | |
|----------------|-----|---|----|
| 53262 | 4,6 | 2 | 40 |
| 240,00€ | Kg | | |

benzina



MODELO

BMW

M52TUB25: 1997-2001 E46 323i/323Ci/323ti (M52T); 1998-2001 E39 523i (M52TU); 1998-2001 E36/7 Z3 (M52TU).

M52TUB28: 1997-2001 E46 328i/328Ci (M52TU); 1997-2001 E36/7 Z3 2.8 (M52B28/Z3); 1998-2001 E39 528i (M52TU); 1998-2001 E38 728i (M52TU).

M54B22: 2001-2003 E46 320i/320Ci; 2001-2003 E39 520i; 2001-2002 E36 Z3 2.2i; 2003-2005 E85 Z4 2.2i; 2003-2005 E60/E61 520i.

M54B25: 2001-2002 E36/7 Z3 2.5i; 2001-2005 E46 325i/325xi; 2001-2006 E46 325Ci; 2001-2004 E46 325ti; 2001-2004 E39 525i; 2003-2004 E60/E61 525i/525xi; 2004-2006 E83 X3 2.5i; 2004-2006 E85 Z4 2.5i.

M54B30: 2001-2005 E46 330i/330xi; 2001-2006 E46 330Ci; 2001-2003 E39 530i/2001-2002 E36 Z3 3.0i; 2003-2005 BMW E60 530i; 2003-2006 E85 Z4 3.0i; 2001-2006 E53 X5 3.0i.

UTENSILI OEM

116150 (1), 113450 (2), 113292 (3), 116180 (4), 114220(5)

ATTREZZO DI REGOLAZIONE ALBERO A CAMME PER BMW M47

| | | | |
|---------------|-----|---|-----|
| 53263 | 1,8 | 5 | 165 |
| 62,50€ | Kg | | |

diesel



MODELO

BMW

BMW 1 SERIES: 118d E87 (04-07), 120d E87 (04-07).

BMW 3 SERIES: 318d/td Compact E46 (01-05), 318d/td E90/91 (05-08), 320d/td Compact E46 (98-05), 320d/cd E90/91 (05-08), 325d E90/91/92/93 (02-10), 330d/cd E46/90/91/92/93 (99-07), 335d E90/91/92 (06-11).

BMW 5 SERIES: 520d E39/60/61 (00-09), 525d/cd E39/60/61 (00-10), 530d/cd E46/60/61 (98-10), 535d E60/61 (04-10).

BMW 6 SERIES: 635d E63/64 (07-11).

BMW 7 SERIES: 730d/ld E38/65/66 (98-08).

BMW X SERIES: X3 2.0d E83 (04-07), X3 3.0d/cd E83 (03-10), X5 3.0d E53/E70 (00-10), X6 3.0d E71/72 (08-10), X6 3.5d E71/72 (08-10).

LAND ROVER: Freelander Td4 (00-06), Range Rover Td6 (02-06).

MG/ROVER: MG-ZT/T (01-05), Rover 75 CDT/CDTi (99-05).

VAUXHALL/OPEL: Omega-B (01-03).

UTENSILI OEM

11.2.300/12-108, 12-171/KM-813 (1), 11.3.340/12-172/KM-823 (2) (3), 11.6.322/12-174/KM-6267 (4) 11.6.320 (5)

CODICE MOTORE

BMW

2.0D: M47, M47T2, M47TU / **2.5D:** M57, M57T2, M57TU / **3.0D:** M57, M57T2, M57TU

LAND ROVER

2.0D: 204D3 (TD4) / **3.0D:** 306D1 (TD6)

MG/ROVER

2.0D: M47R / 2.0d CDT: M47R

VAUXHALL/OPEL

2.5D: Y25DT

ATTREZZO PER FISSAGGIO E REGOLAZIONE ALBERO A CAMME PER BMW N62 / N73

| | | | |
|----------------|------|---|----|
| 53264 | 4,65 | 2 | 40 |
| 145,00€ | Kg | | |

benzina

MODELO

BMW

BMW 5 SERIES: 540i E60/61 (05-10), 545i E60/61 (03-06), 550i E60/61 (05-10).

BMW 6 SERIES: 645i E63/64 (03-06), 650i E63/64 (05-11).

BMW 7 SERIES: 735i E65/66 (02-05), 740i E65/66 (05-10), 745i E65/66 (02-05), 750i E65/66 (05-08), 760i E65/66 (02-08).

BMW X SERIES: X5 4.4 E53 (03-07), X5 4.8 E53/E70 (04-10).

UTENSILI OEM

11.9.463 (1), 11.9.462 (2), 11.9.340 (3), 11.9.461 (4), 11.9.190 (5)

CODICE MOTORE

3.6 V8: N62 B36A

4.4 V8: N62 B44A

6.0 V12: N73 B60A

4.0 V8: N62 B40A

4.8 V8: N62 B48B

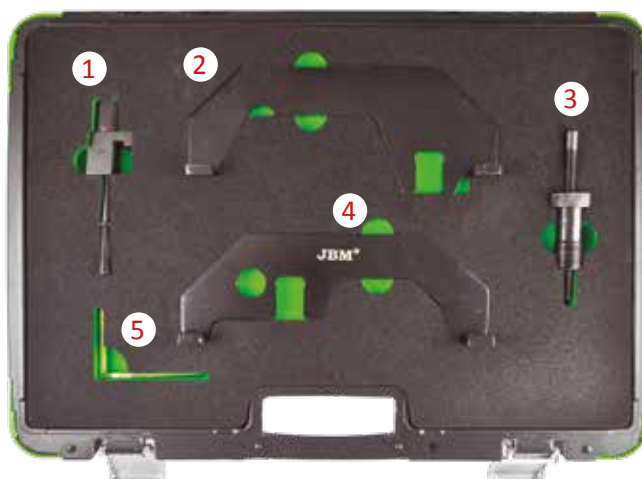

ATTREZZO PER FISSAGGIO E REGOLAZIONE ALBERO A CAMME PER BMW DIESEL

| | | | |
|----------------|------|---|----|
| 53265 | 5,45 | 2 | 40 |
| 197,50€ | Kg | | |

diesel

| | |
|----------------------|--|
| MODELLO | BMW |
| UTENSILI OEM | 113360 (1), 116321 (2), 135190 (3), 135191 (4), 135192 (5), 116322 (6), 112300 (7), 113340 (8) |
| CODICE MOTORE | Motori Diesel M41 / M51 / M47TU / M47TU T2. M57TU T2 3.01 1998 - 2008. |

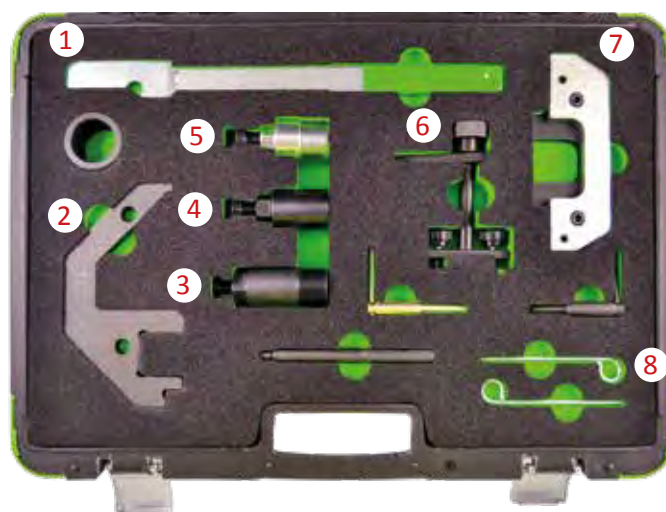

ATTREZZO DI REGOLAZIONE CINGHIA DENTATA PER BMW

| | | | |
|----------------|-----|---|----|
| 53266 | 6,3 | 2 | 42 |
| 217,00€ | Kg | | |

diesel

benzina

| | |
|----------------------|--|
| MODELLO | BMW |
| UTENSILI OEM | 113240 (1), 115490 (2), 113190 (3), 112300 (4) (5), 113292 (6), 113320 (7) |
| CODICE MOTORE | <u>BENZINA</u> : M42, M43, M50, M52, M60. <u>DIESEL</u> : M51 |

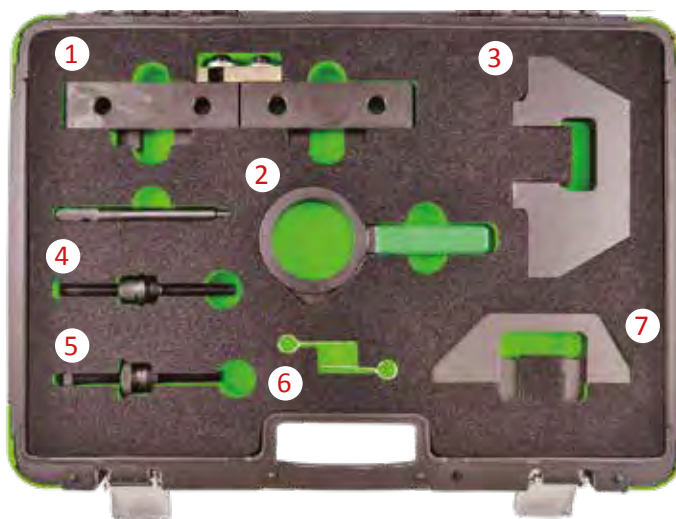

ATTREZZO DI REGOLAZIONE CINGHIA DENTATA PER BMW M42 / 44 / 50 / 52 / 54 / 56

| | | | |
|----------------|----|---|----|
| 53267 | 8 | 2 | 40 |
| 273,00€ | Kg | | |

benzina

| | | |
|----------------------|---|-----------------------|
| MODELLO | BMW | SERIES: 3, 5, 7, X, Z |
| UTENSILI OEM | 114220 (1), 112300 (2), 113240 (3), 115490 (4) 113292 (5), 113450 (6) | |
| CODICE MOTORE | M40. M44. M50. M52. M54. M56. | |

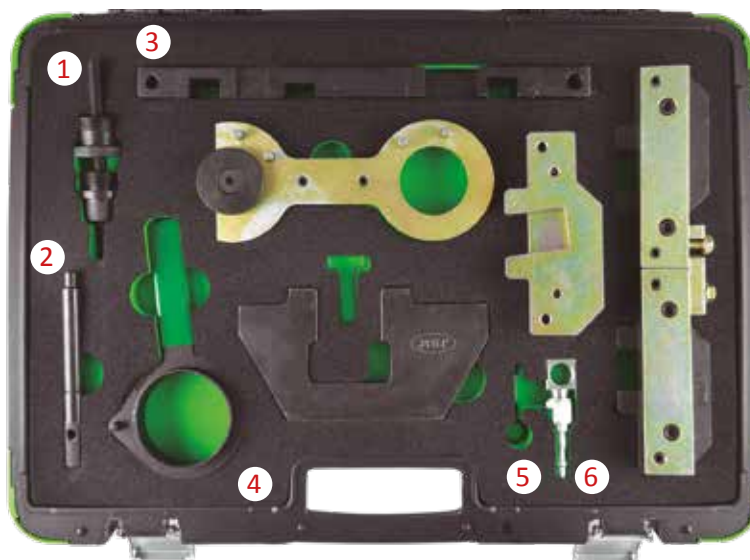

ATTREZZO DI REGOLAZIONE CINGHIA DENTATA PER BMW MINI / PSA 1.4 / 1.6

| | | | |
|----------------|------|----|-----|
| 53268 | 2,65 | 5 | 135 |
| 119,00€ | Kg | ff | ff |

benzina

| | |
|----------------------|---|
| MODELLO | <p>BMW MINI: Mini Clubvan R55 (12-14), Mini Clubman R55 (08-14), Mini Countryman R55 (07-10), Mini Clubman R56/R57 (07-15), Mini R56/R57 (08-15), Mini Coupe R58 (11-15), Mini Roadster R59 (08-15), Mini Clubman R60 (10-14), Mini Clubvan R60 (12-14), Mini Roadster R61 (13-15), Mini Paceman R61 (14-15), Mini Countryman R60 (10-17).</p> <p>CITROËN: C4 (08-11), C4 Picasso (08-13) C4 Grand Picasso (13-15).</p> <p>PEUGEOT: 207 (06-14), 207CC (07-15), 308 (07-15), 3008 (09-15), 5008 (09-15).</p> |
| UTENSILI OEM | <p>BMW MINI: 11 5 590 (1), 11 9 340 (2), 11 9 551 (3)</p> <p>CITROËN: 0197-A1, 0197-A3, 0197-B.</p> <p>PEUGEOT: 0197-A1, 0197-A3, 0197-BZ.</p> |
| CODICE MOTORE | <p>1.4: N12B14, N14B14AB.</p> <p>1.6: EP3(8FS), EP3C(8FR), EP6(5FW), EP6C(5FS), EP6CDT(5FV), EP6DT(5FT), EP6D-T(5FX), EP6DTS(5FY), N14B16A, N14B16CD, N14B16TO, N14B16CD/TO, N16B16A, N16B16KO, N16B16A/MO, N16B16A/MO, N16B16MO, N16B16UO.</p> |



ATTREZZO DI REGOLAZIONE CINGHIA DENTATA PER BMW

| | | |
|---------------|------|----|
| 53269 | 1,25 | 10 |
| 51,00€ | Kg | ff |

diesel

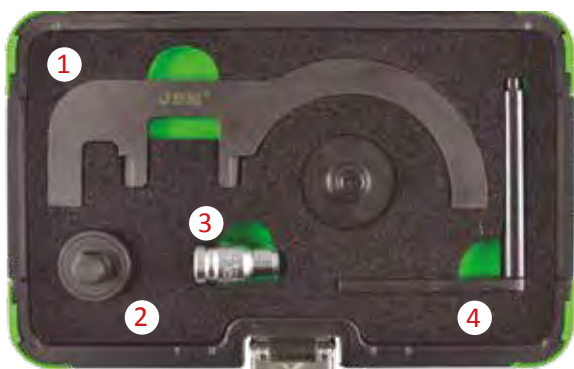

| | |
|----------------------|---|
| MODELLO | <p>BMW</p> <p>BMW 1 SERIES: 116d E81/82/87/88 (08-12), 118d E81/82/87/88 (07-14), 120d E81/82/87/88 (07-14), 123d E81/82/87/88 (07-14).</p> <p>BMW 2 SERIES: 218d (11-14), 220d (11-14), 225d (11-14).</p> <p>BMW 3 SERIES: 316d E90/91/92/93 (09-12), 318d E90/91/92/93 (07-12), 320d E90/91/92/93 (07-12), 325d E90/91/92/93 (10-14), 330d/xd E90/91/92/93 (08-14).</p> <p>BMW 5 SERIES: 520d E60/61 (07-10), 525d F10/11 (10-12), 530d F10/11 (10-13), 530dGT F07 (09-12), 535d F10/11 (10-17), 535dGT F07 (10-12).</p> <p>BMW 7 SERIES: 730d/Ld F01/02/04 (08-12), 740d F01/02/04 (09-12), 740d xDrive F01/02/04 (09-12), 750d xDrive F01/02/04 (12-15).</p> <p>BMW X SERIES: X1 sDrive 18d E84 (09-15), X1 sDrive 20d E84 (09-15), X1 xDrive 18d E84 (09-15), X1 xDrive 20d E84 (09-15), X1 xDrive 23d E84 (09-12), X3 2.0d E83 (07-10), X3 xDrive 18d E83 (08-10), X3 xDrive 30d E83 (11-12), X3 xDrive35d F25 (11-17), X5 3.0d E70 (10-13), X5 xDrive 40d X5 F15 M50d (13-17), E70 (10-13), X6 xDrive 30d E71/72 (10-14), X6 xDrive 40d E71/72 (10-14), X6 F16 M50d (14-17).</p> <p>BMW MINI: Paceman (13-17), Countryman (10-17), Mini (10-15), Roadster (12-14), Clubman (10-14), Clubvan (12-14).</p> |
| UTENSILI OEM | 11.8.760 (1), 1.8.740 (2), 11.6.480 (3), 11.5.320 (4) |
| CODICE MOTORE | <p>1.6 D: N47; C16K1, C16U1.</p> <p>2.0 D: N47; C20K1, C20U1N47; D20, D20A, D20B, D20D, D20K1, D20O0, D20O1, D20T1, D20U0, D20U1, N47S D20T0, N47T; D20, D20O1, D20U1.</p> <p>3.0 D: N57; B30B, B30B/TO, B30C, D30BTO, D30O0, D30O1, D30TO, D30T1, D30U0.</p> |

ATTREZZO DI REGOLAZIONE CINGHIA DENTATA PER MERCEDES / CHRYSLER / JEEP

| | | |
|---------------|-----|----|
| 53270 | 1,4 | 10 |
| 68,50€ | Kg | ff |

diesel

benzina

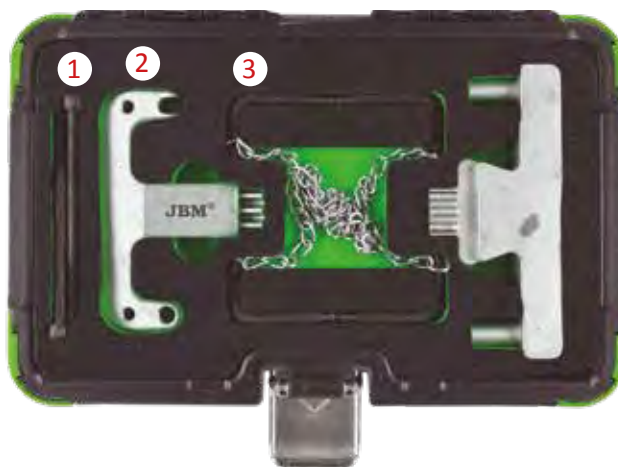

| | |
|----------------------|---|
| MODELLO | <p>MERCEDES</p> <p>CHRYSLER</p> <p>JEEP</p> |
| UTENSILI OEM | 112 589 03 40 00 (1), 601 589 02 40 00 (2), 111 589 03 15 00 (3) |
| CODICE MOTORE | <p>Herr: 112 589 03 40 00: 112, 113, 137, 155, 156, 272/979, 273, 629, 642/992.</p> <p>Herr: 601 589 02 40 00: 102, 103, 104, 111, 601, 602.91/93/94/96/983, 603.91/93/96/97, 604, 605, 606, 611, 612/965/966, 613.</p> <p>Herr: 111 589 03 15 00: 111, 119, 604, 605, 606, 611/980, 612, 613, 628, 629, 640, 642/922, 612.965/966, 646, 647, 648.</p> |

KIT PER LA MESSA IN FASE DELLA DISTRIBUZIONE PER BMW

| | | | |
|----------------|------|---|----|
| 51940 | 5,67 | 3 | 60 |
| 439,00€ | Kg | | |

diesel

benzina

Permette il corretto allineamento dell'albero a camme e dell'albero motore per il cambio della cinghia o la catena di distribuzione in motori a benzina e diesel.

Include una chiave per la corretta rotazione del pignone dell'albero a camme di scarico durante l'installazione e la disinstallazione dell'unità VANOS.

Include utensile di precarico della catena primaria della distribuzione per la messa in tensione della catena di distribuzione in motori M59, filetto metrico 22 per motori M42/M60 e filetto metrico 26 per motori M50/M52.

Per motori: M42 / M44 / M50 / M52 / M54 / M56



ATTREZZO DI REGOLAZIONE CINGHIA DENTATA PER MERCEDES BENZ M271

| | | | |
|----------------|------|---|----|
| 53271 | 4,55 | 2 | 40 |
| 228,00€ | Kg | | |

diesel

benzina

| | |
|----------------------|--|
| MODELLO | MERCEDES |
| UTENSILI OEM | 271 589 003100 (1), 271589014000 (2), 271589001500 (3) |
| CODICE MOTORE | M271. E18ML 2002. DE18ML 2003 - 2005. E16ML 2008. DE18LA 2009. |

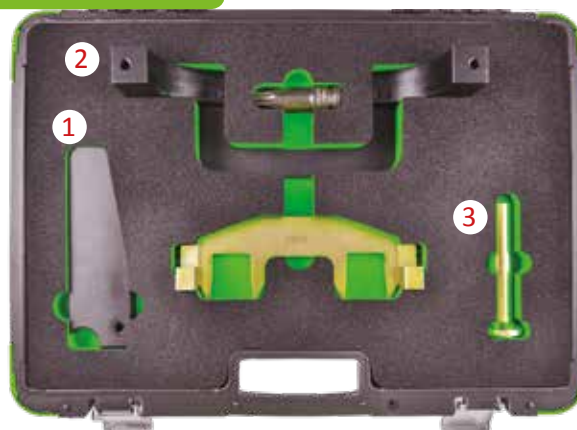

SET ATTREZZI DI ALLINEAMENTO PER MERCEDES BENZ AMG 156

| | | |
|----------------|-----|---|
| 53272 | 2,1 | 5 |
| 179,50€ | Kg | |

diesel

benzina

| | |
|----------------------|---|
| MODELLO | MERCEDES |
| UTENSILI OEM | 156 589 00 61 00 (1), 156 589 00 32 00 (2), 156 589 01 63 00 (3), 156 589 00 61 00 (3) |
| CODICE MOTORE | BENZ AMG 156.ML 63 AMG.S 63L AMG.S 63. AMG. R 63 AMG L 4MATIC. R63 AMG 4MATIC. E 63 AMG. CLS 63 AMG. CLK 63 AMG. CLK 63 AMG Black series. CLK 63 AMG Cabrio. CL 63 AMG. |



ATTREZZO DI REGOLAZIONE CINGHIA DENTATA PER MERCEDES M276 / M157 / M278

| | | |
|---------------|----|----|
| 53273 | 1 | 10 |
| 75,00€ | Kg | |

diesel

benzina



| | | | | | | | | | | | | | | | | | | | | | |
|---|--|------------------------------------|---------------------|------------------------------|----------------------------|-----------------------|------------------------|-----------------------------------|--|---|-------------------------|-----------------------|--------------------------------------|---|--------------------------------|------------------------------------|--------------------------------------|---|----------------------------|--|-----------------------|
| MODELLO | MERCEDES | | | | | | | | | | | | | | | | | | | | |
| UTENSILI OEM | 27658901400 | | | | | | | | | | | | | | | | | | | | |
| CODICE MOTORE | <table border="0"> <tr> <td>CL 500 / 63 AMG (C 216) 2010-2013.</td> <td>C 400 (W 205) 2014.</td> </tr> <tr> <td>S 500 / 63 AMG (C 217) 2014.</td> <td>E 400 HYBRID (W 212) 2012.</td> </tr> <tr> <td>CLS 300 (C 218) 2012.</td> <td>G 63 AMG (W 463) 2012.</td> </tr> <tr> <td>E 300 / 350 / 400 (C/A 207) 2011.</td> <td>E 300 / 350 / 400 / 500 / 63 AMG (W/S 212) 2011.</td> </tr> <tr> <td>CLS 350 / 400 / 500 / 63 AMG (C/X 218) 2011-2014.</td> <td>C 350 (W/S/C 204) 2011.</td> </tr> <tr> <td>SLK 350 (R 172) 2011.</td> <td>S 350 / 500 / 63 AMG (W/V 221) 2010.</td> </tr> <tr> <td>SL 350 / 400 / 500 / 63 AMG (R 231) 2012.</td> <td>S 400 / 63 AMG (W/V 222) 2013.</td> </tr> <tr> <td>S 500 PLUG-IN HYBRID (V 222) 2014.</td> <td>R 350 BlueEFFICIENCY (W/V 251) 2012.</td> </tr> <tr> <td>ML 300 / 350 / 500 / 63 AMG (W 166) 2011.</td> <td>GL 450 / 500 (X 166) 2012.</td> </tr> <tr> <td></td> <td>GLK 350 (X 204) 2011.</td> </tr> </table> | CL 500 / 63 AMG (C 216) 2010-2013. | C 400 (W 205) 2014. | S 500 / 63 AMG (C 217) 2014. | E 400 HYBRID (W 212) 2012. | CLS 300 (C 218) 2012. | G 63 AMG (W 463) 2012. | E 300 / 350 / 400 (C/A 207) 2011. | E 300 / 350 / 400 / 500 / 63 AMG (W/S 212) 2011. | CLS 350 / 400 / 500 / 63 AMG (C/X 218) 2011-2014. | C 350 (W/S/C 204) 2011. | SLK 350 (R 172) 2011. | S 350 / 500 / 63 AMG (W/V 221) 2010. | SL 350 / 400 / 500 / 63 AMG (R 231) 2012. | S 400 / 63 AMG (W/V 222) 2013. | S 500 PLUG-IN HYBRID (V 222) 2014. | R 350 BlueEFFICIENCY (W/V 251) 2012. | ML 300 / 350 / 500 / 63 AMG (W 166) 2011. | GL 450 / 500 (X 166) 2012. | | GLK 350 (X 204) 2011. |
| CL 500 / 63 AMG (C 216) 2010-2013. | C 400 (W 205) 2014. | | | | | | | | | | | | | | | | | | | | |
| S 500 / 63 AMG (C 217) 2014. | E 400 HYBRID (W 212) 2012. | | | | | | | | | | | | | | | | | | | | |
| CLS 300 (C 218) 2012. | G 63 AMG (W 463) 2012. | | | | | | | | | | | | | | | | | | | | |
| E 300 / 350 / 400 (C/A 207) 2011. | E 300 / 350 / 400 / 500 / 63 AMG (W/S 212) 2011. | | | | | | | | | | | | | | | | | | | | |
| CLS 350 / 400 / 500 / 63 AMG (C/X 218) 2011-2014. | C 350 (W/S/C 204) 2011. | | | | | | | | | | | | | | | | | | | | |
| SLK 350 (R 172) 2011. | S 350 / 500 / 63 AMG (W/V 221) 2010. | | | | | | | | | | | | | | | | | | | | |
| SL 350 / 400 / 500 / 63 AMG (R 231) 2012. | S 400 / 63 AMG (W/V 222) 2013. | | | | | | | | | | | | | | | | | | | | |
| S 500 PLUG-IN HYBRID (V 222) 2014. | R 350 BlueEFFICIENCY (W/V 251) 2012. | | | | | | | | | | | | | | | | | | | | |
| ML 300 / 350 / 500 / 63 AMG (W 166) 2011. | GL 450 / 500 (X 166) 2012. | | | | | | | | | | | | | | | | | | | | |
| | GLK 350 (X 204) 2011. | | | | | | | | | | | | | | | | | | | | |

KIT DI ATTREZZI DI ALLINEAMENTO ALBERO A CAMME VW / AUDI

| | | | |
|----------------|-----|---|-----|
| 53280 | 3,5 | 5 | 165 |
| 107,50€ | | | |

benzina

| | |
|----------------------|--|
| MODELLO | AUDI: A4 (01-08), A6 (01-08), A8 (03-10). |
| UTENSILI OEM | 3387 (1), T40030 (2) (4), T40026 (3), T40028 (5) |
| CODICE MOTORE | 3.0 V6 30v: ASN, AVK, BBJ, BGN. |



ATTREZZO DI REGOLAZIONE CINGHIA DENTATA PER AUDI V6 2.0 / 2.8 / 3.0 TFSI

| | | | |
|----------------|------|---|----|
| 53278 | 4,75 | 2 | 40 |
| 145,50€ | | | |

benzina

| | |
|----------------------|---|
| MODELLO | AUDI: Q5, V6 2.0, 2.8, 3.0T FSI SEAT: Ibiza/Cordoba, Toledo, Alhambra, Inca 1.6, 1.8, 1.8 16v, 2.0, 2.0 16v, Ibiza/Cordoba, Leon, Toledo 1.6 (99-), Alhambra 2.0 (00-). VOLKSWAGEN: V6 2.0, 2.8, 3.0T FSI. AUDI/VOLKSWAGEN: V6 2.0, 2.8, 3.0T FSI. AUDI Q5: 2.0, A6L 2.8, 3.0T. |
| UTENSILI OEM | T10172 (1), 3212 (2), T40070 (3), T40069 (4), T40071 (5), T10172/2 (6) |
| CODICE MOTORE | 2.0, 2.8, 3.0 |



SET CHIAVI A DUE PERNI PER CINGHIA DENTATA PER VW / AUDI

| | | | |
|---------------|-----|---|-----|
| 53277 | 1,6 | 5 | 165 |
| 37,50€ | | | |

diesel

benzina



| | |
|----------------------|---|
| MODELLO | BENZINA AUDI: 80, 100, A3, A4, A6 1.6, 1.8/Turbo, 2.0, 2.0 16v, A3, A4 1.6 (96-). SEAT: Ibiza/Cordoba, Toledo, Alhambra, Inca 1.6, 1.8, 1.8 16v, 2.0, 2.0 16v, Ibiza/Cordoba, Leon, Toledo 1.6 (99-), Alhambra 2.0 (00-). VOLKSWAGEN: Polo Classic, Scirocco, Corrado, Golf, Jetta, Vento, Passat, Sharan, Transporter 1.6, 1.8/Turbo, 1.8 16v, 2.0, 2.0 16v, Polo Classic, Golf, Bora, Beetle 1.6 (97-), 2.0 (99-). SKODA: Octavia 1.6 (97-), 2.0 (99-). |
| MODELLO | DIESEL AUDI: 80, 100, A3, A4, A6 1.9 Turbo D, 1.9TDi, 2.5TDi, A3, A4, A6 2.0TDi, A2, A3, A4, A6 1.2TDi, 1.4TDi, 1.9TDi (99-). SEAT: Ibiza/Cordoba, Leon, Toledo, Alhambra, Inca 1.7SDi, 1.9D/TD /Sdi/Tdi. FORD: Galaxy (02-06). SKODA: Felicia, Octavia 1.9D/Tdi. VW: Polo, Polo Classic, Golf, Jetta, Vento, Bora, Beetle, Passat, Sharan, Caddy, Transporter 1.5D, 1.6D/ Turbo, 1.7D/Sdi, 1.9Sdi/Tdi, Golf, Passat 2.0TDi. |
| UTENSILI OEM | T10020 (1), 3387 (2), V159 (3), T10060/T100604 (4), T10115 (5), T40011 (6) |
| CODICE MOTORE | 2.0, 2.8, 3.0 |

ATTREZZO DI REGOLAZIONE CINGHIA DENTATA PER AUDI / SKODA

| | | | |
|----------------|-----|---|----|
| 53276 | 5,3 | 2 | 40 |
| 161,00€ | | | |

diesel

benzina

| | |
|----------------------|---|
| MODELLO | MOTORE AUDI, VW: V6 2.0, 2.8, 3.0T FSI. AUDI Q5: 2.0, A6L 2.8, 3.0T. |
| UTENSILI OEM | T0016 (1), T10123 (2) (3), T10098A (5), T10264 (7), T10265 (8), 3369 (12), T10120 (13), T10008 (15), T10060/T10060A (18), 2064 (19), T20102/3359 (21), T10050 (22) T10100 (23), 3458 (26) |
| CODICE MOTORE | 2.0, 2.8, 3.0 |

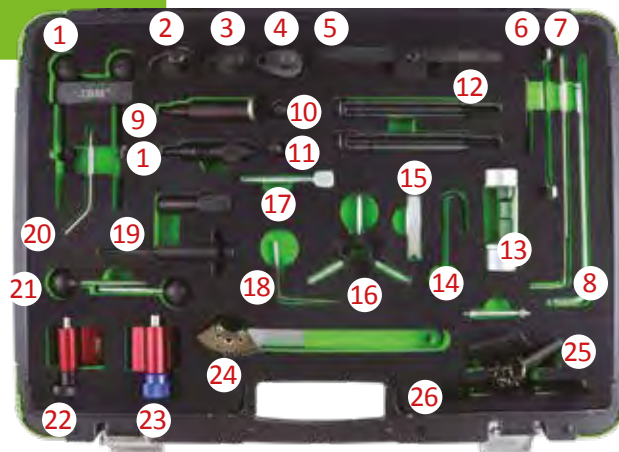

KIT DI ATTREZZI DI ALLINEAMENTO ALBERO A CAMME VW / AUDI

| | | |
|---------------|-----|----|
| 53281 | 1,3 | 5 |
| 59,00€ | Kg | 11 |

diesel

| | |
|----------------------|---|
| MODELO | VOLKSWAGEN: 2.5 TDi V6 DIESEL AUDI: A4, A6, A8 |
| UTENSILI OEM | 3369 (1), 3242 (2), 3458 (3) |
| CODICE MOTORE | AFB/AKN |



ATTREZZO DI REGOLAZIONE CINGHIA DENTATA PER VW / AUDI

| | | | |
|---------------|------|----|-----|
| 53282 | 1,75 | 5 | 135 |
| 53,00€ | Kg | 11 | 11 |

benzina

| | |
|----------------------|---|
| MODELO | SEAT: Alhambra (10-15), Altea/Altea XL (08-15), Ibiza/ Cordoba (08-12), Leon (07-13), Toledo (07-15). VOLKSWAGEN: Beetle (11-15), Caddy/Caddy Maxi (10-15), EOS (06-12), Golf (03-12), Golf Plus (03-14), Golf V Estate (07-13), Golf VI Cabriolet (10-15), Jetta (06-14), Passat (05-11), Polo (02-14), Scirocco (08-12), Tiguan (07-12), Touran (03-15). SKODA: Fabia II (07-15), Octavia II (04-15), Praktik (10-15), Rapid (12-15), Roomster (06-15), Superb II (09-14), Yeti (09-14). AUDI: A1 (10-15), A3 (03-13). |
| UTENSILI OEM | T10171 (1), T10170 (2), T40011 (3) |
| CODICE MOTORE | 1.2 TFSI: CBZA, CBZB, CBZC. 1.4 FSI: AXU, BKG, BLN. 1.4 TFSI: BLG, BMY, BWK, CAVA, CAVB, CAVC, CAVD, CAVE, CAVF, CAXA, CAXC, CDGA, CSMA. 1.6 FSI: BAG, BLF, BLP, BTS. |



ATTREZZO DI REGOLAZIONE CINGHIA DENTATA PER VW / AUDI 2.0TFSI

| | | | |
|---------------|-----|----|-----|
| 53279 | 2,1 | 5 | 135 |
| 98,00€ | Kg | 11 | 11 |

benzina

| | |
|----------------------|--|
| MODELO | AUDI: A3 (96-09), A4 (94-09), A6 (95-11), S3 (99-13), TT (98-14). SEAT: Alhambra (97-10), Altea/Altea XL (06-09), Cordoba (99-02), Exeo (09-10), Ibiza (99-02), Leon (99-13), Toledo (99-09). SKODA: Octavia/Octavia Tour (98-10), Octavia II (04-09). VOLKSWAGEN: Beetle (99-11), Bora (97-04), Eos (06-10), Golf (97-12), Golf Plus (05-09), Jetta (05-09), Passat (96-10), Scirocco (09-14), Sharan (97-10), Touran (03-09). |
| UTENSILI OEM | T10020 (1), T10252 (2), T10092 (3), T10115 (4), T40011 (4), 3366 (5), T10060 (6) |
| CODICE MOTORE | 1.8: ADR, AFY, AGN, AJP, APG, APT, AQE, ARG, ARH, AVV. 1.8T: AEB, AGU, AJH, AJL, AJQ, AMK, AMU, ANB, APP, APU, APX, APY, AQA, AQX, ARX, ARY, ARZ, AUM, AUQ, AVC, AWC, AWT, AWU, AYP, BAM, BFV, BVP, BVR. 2.0 FSI: AXW, BHD, BLR, BLX, BLY, BMB, BVX, BVY, BVZ. 2.0 TFSI/S/R/Tsi: AXX, BPY, BWA, BGB, BPG, BPI, BUL, BWE, BWT, BYK, BHZ, BZC, BWJ, BYD, CDLA, CDLB, CDLC, CDLD, CDLF, CDMA. |



ATTREZZO DI REGOLAZIONE CINGHIA DENTATA PER VOLKSWAGEN / SEAT / SKODA 1.2L

| | | |
|---------------|------|----|
| 53274 | 1,05 | 10 |
| 44,00€ | Kg | 11 |

benzina

| | |
|----------------------|--|
| MODELO | VOLKSWAGEN 1.2: Lupo / Polo / Eos / Fox. SEAT 1.2: Ibiza / Cordoba SKODA 1.2: Fabia |
| UTENSILI OEM | T10123 (1) (2), T10120 (3), T10121 (4) |
| CODICE MOTORE | AWY / BMD / AZQ / BME. |



ATTREZZO DI REGOLAZIONE CINGHIA DENTATA PER VW / AUDI

53326
15,00€

| | | |
|-----|-----|----|
| 0,3 | 10 | 40 |
| Kg | 5.6 | 11 |

diesel



1

MODELO
VW: V6 2.5TDi.
AUDI: V6 2.5TDi, V8 3.3TDi.

UTENSILI OEM
3458 (1), T40069 (2)

ATTREZZO DI REGOLAZIONE CINGHIA DENTATA PER VW 1.2L

53327
15,00€

| |
|-----|
| 0,2 |
| Kg |
| 10 |
| 60 |
| 11 |

benzina



MODELO
AUDI: A1, A3, A3 cabrio 1.2 TSI.
VW: Polo, Touran, Caddy, Caddt maxi, Golf, Golf plus, Golf estate, Jetta, Golf VI cabrio.

UTENSILI OEM
T10414.

CODICE MOTORE
CBZA, CBZB.

ATTREZZO DI REGOLAZIONE CINGHIA DENTATA PER VAG 2.7 / 3.0 TDI

53283
101,50€

| | |
|-----|----|
| 2,1 | 5 |
| Kg | 11 |

diesel



MODELO
VOLKSWAGEN: Touareg, Phateon
VAG: Diesel 2.7 / 3.0 V6
AUDI: A4, A5, A6

UTENSILI OEM
3242 (1), T40060 (2) (3), 3359 (4), T40058 (5),
T40061 (6), T40062 (7), T40049 (8)

CODICE MOTORE
AJB, BKN, BKS, BWZ, BNG, BPP, BSG, BUG, BUN,
CAWA, CAMB, CANA, CANB, CANC, CAND, CAPA,
CARA, CARs, CASA, CASE, CASC, CAM, CC/HA, CCWA,
CCWB, CDYA, CDVB, CDVC, CEXA, CGKA, CGKB.

ATTREZZO DI REGOLAZIONE CINGHIA DENTATA PER VAG 2.5 / 4.9D / TDI

53284
313,50€

| | | |
|-----|----|----|
| 9,4 | 2 | 42 |
| Kg | 11 | 11 |

diesel



MODELO
VOLKSWAGEN: Touareg (03-10), Transporter (03-09).

UTENSILI OEM
T10225 (1), T10199 (2), T10234 (3), T10226 (4), T10193
(5), T10194 (6), T10199/01 (7), T10226 (8)

CODICE MOTORE
2.5D TDi PD: AXD, AXE, BAC, BLJ, BLK, BNZ, BPC, BPD, BPE.

ATTREZZO DI REGOLAZIONE CINGHIA DENTATA PER VAG 2.4 / 2.5D SDI

| | | | |
|---------------|----|---|-----|
| 53285 | 2 | 5 | 135 |
| 53,50€ | Kg | | |

diesel

| | |
|----------------------|---|
| MODELLO | VOLKSWAGEN: Crafter (06-13), LT (96-06), Transporter (90-03). |
| UTENSILI OEM | 2065A (1), T50009 (2), T10025 (3), 3248/3419 (4), 2064 (5), 3355 (6) |
| CODICE MOTORE | 2.4D: AAB, AJA. 2.5D SDI: AGX. 2.5D Tdi: ACV, AHD, AHY, AJT, ANJ, APA, AUF, AVR, AXG, AXL, AYC, AYY, BBE, BBF. 2.5D TDiCR: BJJ, BJK, BJL, BJM. |



ATTREZZO DI REGOLAZIONE CINGHIA DENTATA PER VAG 1.8 / 2.0TSI

| | | | |
|----------------|----|---|-----|
| 53286 | 2 | 5 | 135 |
| 104,50€ | Kg | | |

benzina

| | |
|----------------------|---|
| MODELLO | VOLKSWAGEN: 1.8 / 2.0 TSI / TFSI. |
| UTENSILI OEM | T10368 (2), T10354 (3), T40271 (4), T10352/2 (5), T10352/1 (6), T10352 (7), T40196 (8) (9) (10) (11), T40267 (12) (13), T40098 (14), T10060A (15), T40011 (15) |
| CODICE MOTORE | BYT, BZB, CABA, CABB, CABD, CADA, CAEA, CAEB, CAWA, CAWB, CBFA, CCTA, CCZA, CCZB, CCZC, CDAA, CDAB, CDHA, CDHB, CDNB, CDNC, CDND, CESA, CETA, CFKA, CGYA, CJEB, CJBA, CJSB. |

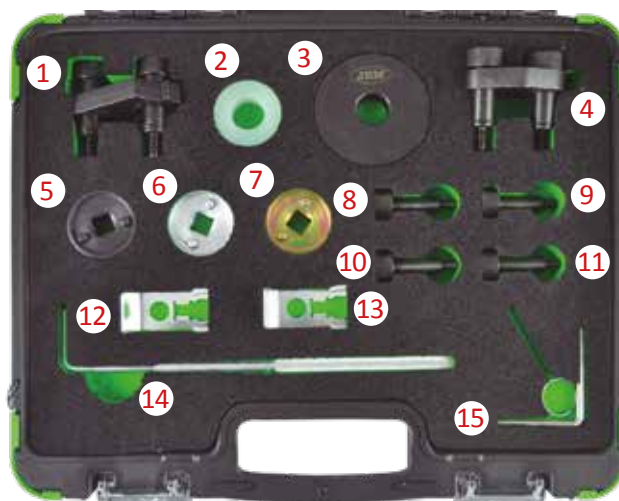

ATTREZZO DI REGOLAZIONE CINGHIA DENTATA PER VW / AUDI 1.8 / 2.0L TURBO

| | | | |
|----------------|-----|---|----|
| 53287 | 4,6 | 2 | 40 |
| 244,00€ | Kg | | |

benzina

| | | |
|----------------------|--|-----------------|
| MODELLO | VOLKSWAGEN AUDI | 1.8 / 2.0 TURBO |
| UTENSILI OEM | T10355 (1), T40196 (2), T40271 (3) (4), T10352 (5), T10352/1 (6), T10352/2 (7), T10368 (7), T40267 (8), T10354 (9), T40265 (10), T40011 (11) (14), T40098 (12), T10060A (13) | |
| CODICE MOTORE | BYT, BZB, CABB, CABD, CADA, CAEA, CAEB, CAWA, CAWB, CBFA, CCTA, CCZA, CCZB, CCZC, CDAA, CDAB, CDHB, CDNB, CDNC, CDND, CESA, CETA, CFKA, CGYA, CJEB, CISA, CJSB. | |

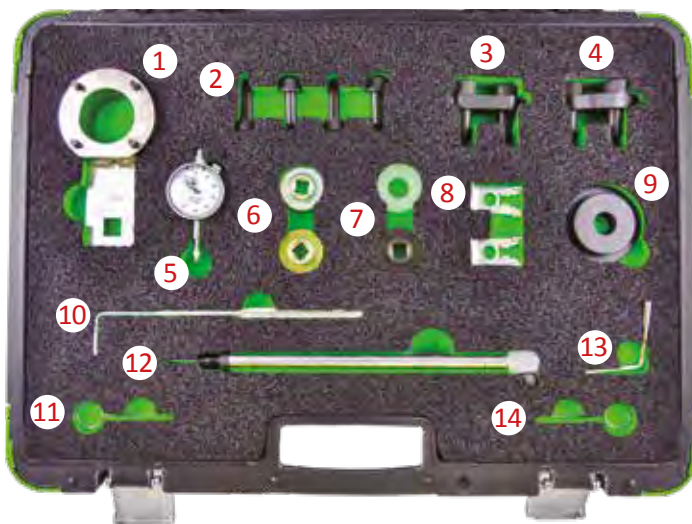

ATTREZZO DI REGOLAZIONE CINGHIA DENTATA PER VW / AUDI

53275
39,50€

| | | |
|-----|----|-----|
| 0,7 | 10 | 330 |
| Kg | ff | ff |

diesel

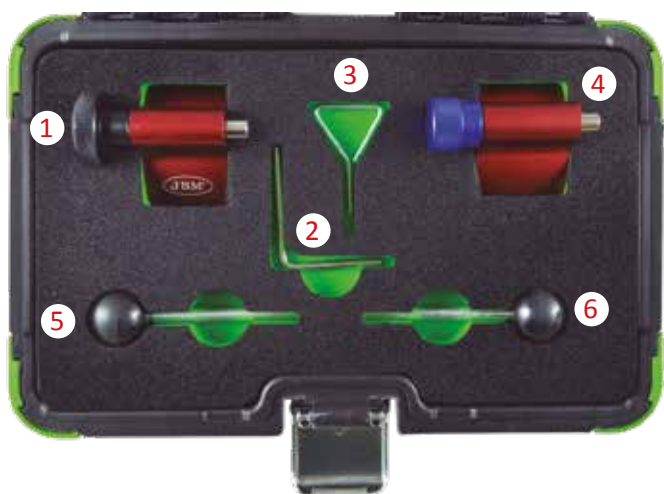

MODELLO

DODGE: Caliber (06-11)
FORD: Galaxy (02-06)
MITSUBISHI: Grandis (05-10), Lancer (05-10), Outlander (07-10).
SEAT: Alhambra (00-15), Altea/Altea XL (04-15), Cordoba (02-09), Ibiza (02-15), Leon (00-13), Toledo (04-11).
SKODA: Fabia (00-14), Fabia II (07-15), Octavia (00-10), Octavia II (04-15), Praktik (10-15), Rapid (11-15), Roomster (07-15), Superb (02-08), Superb II (08-15), Yeti (09-14).
AUDI: A1 (10-15), A2 (00-06), A3 (01-13), A4/Allroad (01-16), A5 (08-15), A6 (11-14), TT (08-14), Q3 (11-15), Q5 (08-15), A6 (10-14).
VOLKSWAGEN: Amarok (10-16), Beetle (02-15), Bora (02-08), Caddy/Maxi (03-15), EOS (06-15), Fox (05-11), Golf (02-15), Golf Plus (05-14), Jetta (05-15), Lupo (02-05), Passat/CC (02-15), Polo (99-14), Scirocco (08-14), Sharan (02-15), Tiguan (07-15), Touran (03-15), Transporter (03-17).

UTENSILI OEM

DODGE: 9882, 9883.
FORD: 310-085/23-059, 303-1054.
MITSUBISHI: MB995206, MB995208, MB995209.
VAG: T10100 (4), T10050 (1), 3359 (3/6)/T20102, T10115 (3), T10060A (2)/T40098, T20167.

CODICE MOTORE

1.2D TDi CR: CFWA.
1.4D TDi PD: AMF, BAY, BMS, BNM, BNV, BWB.
1.6D TDi CR: CAYA, CAYB, CAYC, CAYD, CAYE, CLNA.
1.9D TDi PD: AJM, ANU, ARL, ASZ, ATD, AUJ, AVB, AVF, AVQ, AWX, AXB, AXC, AXR, BJB, BKC, BLS, BLT, BMT, BPZ, BRM, BRR, BRS, BRU, BSU, BSV, BSW, BTB, BVK, BXE, BXF, BXJ.
2.0D TDi CR/TDi PD: AZV, BDJ, BDK, BEW, BGW, BHW, BKD, BKP, BKQ, BLB, BMA, BMM, BMN, BMP, BMR, BNA, BPW, BRA, BRC, BRD, BRE, BRF, BRT, BSS, BST, BSY, BUY, BUZ, BVA, BVE, BVF, BVG, BVH, BWC, BWV, CAAA, CAAB, CAAC, CAAD, CAE, CAGA, CAGB, CAGC, CAHA, CAHB, CBAA, CBAB, CBAC, CBBA, CBBB, CBDA, CBDB, CBDC, CBEA, CCHA, CCHB, CDBA, CDCA, CEGA, CFCA, CFFA, CFFB, CFFD, CFFE, CFGB, CFGC, CFHA, CFHB, CFHC, CFHD, CFHE, CFHF, CFJA, CGLA, CGLB, CGLC, CGLD, CJAA, CJCA, CJCB, CJCC, CLCA, CLCB, CLJA, CLLA, CNEA, ECD, ECD/BSY, ECD/BYL, ECE/BWD.

ATTREZZO DI REGOLAZIONE CINGHIA DENTATA PER VAG 1.6 / 2.0 TDI COMMON RAIL

53288
79,50€

| | |
|------|----|
| 2,15 | 5 |
| Kg | ff |

diesel



MODELLO

SEAT: Exeo, Leon, Altea, Toledo, Ibiza.
VOLKSWAGEN: Jetta, Touran, Golf, Golf Plus, Polo, Passat, Tiguan, Scirocco.
SKODA: Roomster, Fabia, Praktik, Octavia, Yeti, Superb.
AUDI: A1, A3, A4, A5, Q5, A6, TT.

UTENSILI OEM

T10264 (1), T10265 (2), T20102 (3), T10052 (4), T10051 (5), T10255 (6), T10050 (7), T10100 (8), T40098 (9)

CODICE MOTORE

1.2 TDI CR, 1.6 D TDI CR, 2.0 D TDI CR
 CAGA, CAGB, CAGC, CAHA, CAHB, CFHC, CBAA, CBAB, CFFB, CGLA, CGLB, CJCA, CJCB, CAAA, CBAA, CBAB, CBAC, CBBA, CBBB, CBDA, CBDB, CBDC, CCHA, CEGA, CJAA, CAAB, CAAC, CFJA, CFWA, CAYB, CAYC, CAYA.

KIT PER LA MESSA IN FASE DELLA DISTRIBUZIONE PER SEAT / VW / AUDI / SKODA

51943
219,00€

| | | |
|------|----|----|
| 5,13 | 2 | 64 |
| Kg | ff | ff |



MODELLO

AUDI: 80, 100, A2, A3, A4, A6, TT
SEAT: Terra, Ibiza, Córdoba, Leon, Toledo, Inca, Alhambra
SKODA: Fabia, Felicia y Octavia.
VW: Lupo, Polo/Classic, Caddy, Golf, Jetta, Vento, Bora, New Beetle, Passat, Sharan, Transporter y LT

ATTREZZO DI REGOLAZIONE CINGHIA DENTATA PER RENAULT 1.4 / 1.6 / 1.8 / 2.0 16V

| | | | |
|---------------|-----|---|-----|
| 53289 | 1,5 | 5 | 270 |
| 55,00€ | | | |

benzina

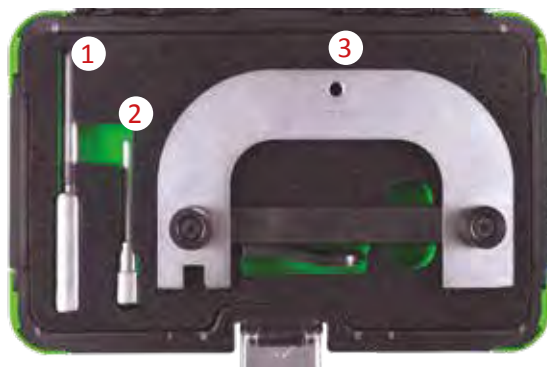

MODELLO

RENAULT: Espace/Grand Espace (98-02), Espace/Grand Espace IV (02-10), Kangoo/Trekka (01-09), Laguna (98-01), Laguna II (01-07), Laguna III (07-13), Megane (99-03), Megane II (02-10), Megane III/Sport (08-13), Megane/Scenic (99-00), Scenic/RX4 (99-03), Scenic/Grand Scenic II (03-09), Trafic II (01-11), Twingo II (08-14), Vel Satis (00-10), Wind (10-14)
DACIA: Logan/MCV (05-11).
NISSAN: Kubistar X76 (03-09), Primastar (02-11).
VAUXHALL/OPEL: Jetta, Touran, Golf, Golf Plus, Polo, Passat, Tiguan, Scirocco.

UTENSILI OEM

Mot1489 (1), Mot1054 (2), Mot1496 (3)

CODICE MOTORE

1.4 16v K4J: 730, 732, 740.
1.6 16v K4M: 752, 753, 760, 761, 764, 788, 812, 813, 854, 856.
1.8 16v F4P: 720, 722, 760, 770, 771, 772, 773, 774, 775.
2.0 16v F4R: 700, 701, 712, 713, 714, 715, 720, 722, 730, 732, 736, 738, 740, 741, 744, 746, 747, 762, 763, 764, 765, 766, 767, 770, 771, 780, 790, 791, 792, 820, 830, 832, 867.
2.0 16v F4R(t): 720, 722, 764, 765, 774, 776, 784, 786, 787, 794, 795, 796, 797, 800, 802, 810, 811, 870, 872, 874, 886, 887, 896, 897.

ATTREZZO DI REGOLAZIONE CINGHIA DENTATA PER RENAULT / VOLVO 16V / 20V

| | | | |
|---------------|-----|---|-----|
| 53290 | 1,9 | 5 | 165 |
| 54,00€ | | | |

benzina



MODELLO

RENAULT: Laguna 2.0 16V / 2.5 20V (1996-1999), Safrane 2.0 16V / 2.5 20V (1996-2001)
VOLVO: 850(1992-1997), C70(1998-2002), S40(1996-2004), V40(1996-2004), S60(2001-2005), S70(1997-2000), S80(1999-2005).

UTENSILI OEM

MOT1348 (1), MOT1337 (2), MOT1340 (3)

CODICE MOTORE

RENAULT: N7Q 704/710/711(2.0 16V), N7U 700/701(2.5 20V).
VOLVO: B4164S, B4164S2, B4184S, B4184S2, B4184S3, B4184S9, B4184S10, B4194T, BS194T2, B420S4, B4204S2, B4204T, B4204T2, B4204T3, B4204T5, B5202Fs, B5204FT, B5204T2, B5204T3, B5204T4, B5204T5, B5234FS, B5204FT, B5234T3, B5234T4, B5234T5, B5234T6, B5234T7, B5234T8, B5234T9, B5244S, B5244S2, B5244SG, B5244SG2, B5244T, B5244T3, B5244T4, B5244T5, B5244T7.

KIT PER LA MESSA IN FASE DELLA DISTRIBUZIONE PER OPEL / RENAULT / NISSAN

| | | | |
|----------------|-----|---|----|
| 51942 | 6,1 | 2 | 64 |
| 219,00€ | | | |

diesel

benzina



Funzioni: Bloccare volano, albero a camme, albero motore, pompa d'iniezione. Cambiare la cinghia della distribuzione. Valido anche per motori identici.

Ad esempio: Opel (Vauxhall), Volvo. Per bloccare l'albero a camme e l'albero motore per il cambio della cinghia di distribuzione o la riparazione del motore Renault.

MODELLO

RENAULT: Avantime, Clio, Espace, Kangoo, Laguna, Master, Megane, Modus, Scenic, Twingo, Traffic
OPEL/VAUXHALL: Movano, Vivaro.

CODICE MOTORE

BENZINA: 2.0 16V, 2.5 20V, 1.4, 1.6 16V, 1.8, 2.0 16V, 1.2, 1.7, 1.8, 2.0 16V, 2.2
DIESEL: 1.5, 1.9, 2.5, 2.8

KIT DI BLOCCAGGIO PER MOTORI DIESEL RENAULT / NISSAN 1.6 DCI

N

| | | |
|---------------|------|---|
| 53523 | 1,45 | 5 |
| 99,00€ | | |

diesel



MODELLO

RENAULT: Espace/Grand Espace IV (06-10), Kaleos (08-11), Laguna II (05-07), Laguna III (07-12), Master III (10-12), Magane II (06-10), Scenic/Grand Scenic II (06-09), Scenic/Grand Scenic III (09-12), Trafic II (06-12), Vel Satis (05-10)
NISSAN: Primastar X83 (06-10), Qashqai/Qashqai+2 J10 (07-10), X-Trail T31 (07-12).
VAUXHALL / OPEL: Movano-B (10-12), Vivaro (06-12).

UTENSILI OEM

MOT1969 (1), MOT1970 (2), MOT1770, MOT1773, EN-48330, EN-48332, EN-48334, EN-48831, KM-6130

CODICE MOTORE

M9R 2.0dCi: 610, 615, 630, 700, 721, 740, 742, 760, 761, 762, 763, 780, 782, 784, 786, 788, 800, 802, 803, 805, 808, 816, 830, 832, 833.
M9T 2.3dCi: 670, 672, 676, 678, 680, 686, 690, 692, 694, 698.

ATTREZZO DI REGOLAZIONE CINGHIA DENTATA PER RENAULT

| | | | |
|---------------|------|---|-----|
| 53291 | 2,50 | 5 | 135 |
| 75,00€ | Kg | | |

benzina

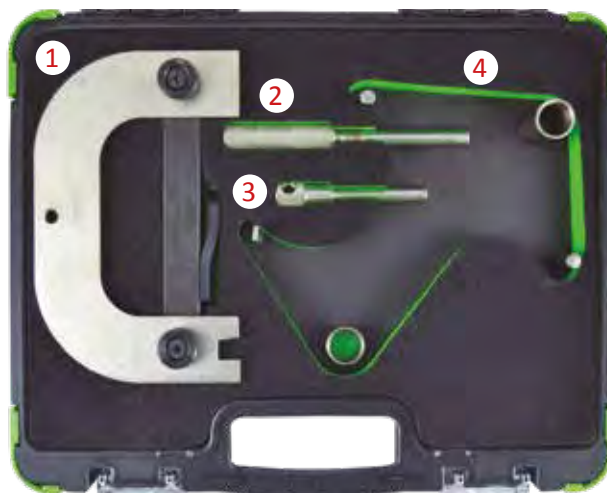

| | |
|----------------------|--|
| MODELLO | RENAULT: Clio, Laguna, Megane |
| UTENSILI OEM | MOT1496 (1), MOT1489 (2), MOT861/1863 (3), MOT1490 (4) |
| CODICE MOTORE | K4J, K4M, F4P, F4R. |

ATTREZZO DI REGOLAZIONE CINGHIA DENTATA PER RENAULT / OPEL 2.2 / 2.5 TDI DCI

| | | | |
|----------------|------|---|-----|
| 53292 | 2,35 | 2 | 165 |
| 131,00€ | Kg | | |

benzina



| | |
|----------------------|--|
| MODELLO | RENAULT: Laguna II, Espace, Master, Trafic, 2.2 / 2.5 DCI OPEL: Vivaro, Movano, DIESEL: 2.2 / 2.5 DTI, Astra B, Vectra B, Signum, Zafira, 2.2 16V |
| UTENSILI OEM | KM6205 (1), KM6204 (2), KM6077 (3) |
| CODICE MOTORE | 2.2 / 2.5 |

ATTREZZO DI REGOLAZIONE CINGHIA DENTATA PER FORD

| | | | |
|----------------|------|---|----|
| 53293 | 4,15 | 2 | 40 |
| 147,00€ | Kg | | |

diesel

benzina

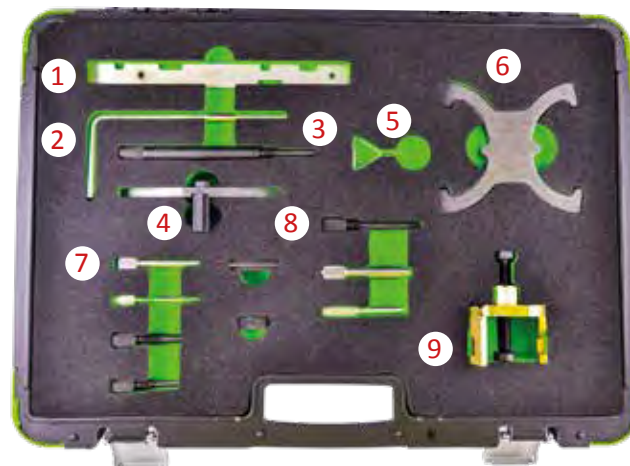

| | | |
|----------------------|--|--|
| MODELLO | FORD | B-Max (12-17), C-Max (07-17), Cougar (98-01), Courier (00-02), Escort (94-98), Fiesta (95-17), Focus (98-17), Focus C-Max (03-07), Fusion (02-12), Galaxy (06-15), Grand C-Max (10-17), Kuga (08-15), Maverick (01-07), Mondeo (93-15), Orion (94-94), Puma (97-02), S-Max (06-15), Tourneo Connect (02-15), Transit (06-11), Transit Connect (02-16), EcoSport (13-15), Tourneo Courier (14-15), Grand Tourneo Courier (13-15). |
| UTENSILI OEM | 303-376 (21-162B) (1) / 303-1059 (2) / 303-193 (21-104) (3) / 303-393-01 (4) / 303-1054 (5) / 303-1097 (6) / 303-748 (7) / 303-734 (21-262) (8) / 303-651 (21-229) (9) / 303-393A (21-168) / 303-393-02 / 303-507 (21-210) / 303-620 (21-163) / 303-732 (21-260) / 303-735 (21-263). | |
| CODICE MOTORE | 1.25 16v Cinghia 1.4 16v Cinghia 1.4D TDCi Cinghia 1.5 EcoBoost 1.6Ti-VCT Cinghia 1.6 EcoBoost Cinghia 1.6D TDCi Cinghia 1.6D TDCi ECONetic Cinghia 1.8 16v Cinghia 1.8 16v Catena | 1.8D TDCi Cinghia 1.8D TDDi Cinghia 1.8D TCI Cinghia 1.8D Turbo Cinghia 2.0 16v Cinghia 2.0 16v Catena 2.0D TDCi Cinghia 2.2D TDCi Cinghia 2.3 16v Catena |

ATTREZZO DI REGOLAZIONE CINGHIA DENTATA PER FORD

| | | | |
|---------------|-----|----|----|
| 53324 | 0,3 | 10 | 50 |
| 13,50€ | Kg | | |

benzina



MODELLO

FORD: B-Max (15-17), C-Max (07-10), Cougar (98-01), Fiesta (95-17), Focus (98-11), Focus C-Max (03-07), Fusion (02-12), Galaxy (06-15), Maverick (01-07), Mondeo (93-15), Puma (97-02), S-Max (06-15), Tourneo Connect (02-06), Transit (06-12), Transit Connect (02-06).
MAZDA: 121 ZQ (95-00), 2 DY (02-07), 3 BK (03-09), 3 BL (09-15), 5 CR (05-10), 5 CW (10-12), 6 GG/GY (02-07), 6 GH (07-15), MPV LW (02-05), MX-5 NC (05-16), Tribute EP (04-06).
VOLVO: C30 (06-13), S40 (06-12), S80 (07-11), V50 (04-12).

UTENSILI OEM

FORD: 303-1054, 303-507 (21-210), 303-620 (21-163), 303-574, 303-748, 303-376 (21-162B), 303-376B
MAZDA: 49 JE01 061, 303-574, 49 JE02 061, 303-465, 49 JE01 054
VOLVO: 999 7152, 999 7151.

CODICE MOTORE

1.4 / 1.6

ATTREZZO DI REGOLAZIONE CINGHIA DENTATA PER FORD / MAZDA

| | | | |
|----------------|-----|---|----|
| 53294 | 3,7 | 2 | 40 |
| 122,50€ | Kg | | |

diesel

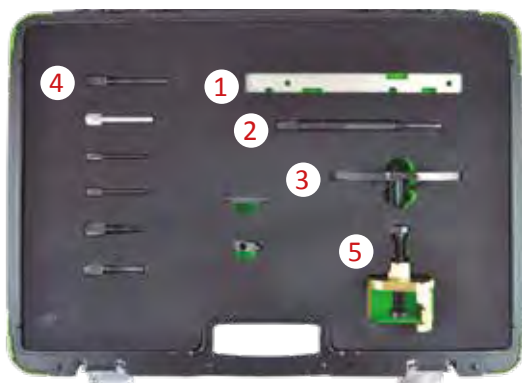

MODELLO

FORD: Courier (00-02), C-Max (03-10), Fiesta (02-11), Focus (98-11), Fusion (02-11), Galaxy (06-10), Kuga (06-10), Mondeo (07-10), S-Max (06-10), Tourneo Connect (02-13), Transit Connect (02-13)
PEUGEOT: Bipper (08-10) Dispatch/Jumpy III (07-12) Expert III (07-12) Nemo (08-10) Partner I/II (05-11) Partner III (08-16) 107 (05-10) 1007 (05-10) 206 (01-12) 206+ (09-13) 206 CC (05-07) 207 (06-13) 207 CC (07-15) 208 (11-15) 307 (01-08) 308 (07-15) 308 CC (09-15) 407 (05-11) 508 (04-15) 2008 (13-15) 3008 (09-15) 4008 (12-15) 5008 (09-15).
MAZDA: 2 (02-15), 3 (09-14)
CITROËN: C1 (05-10), C2 (03-10), C3 I/II (02-10), C3 III (10-15), C3 Pluriel (04-10), C3 Picasso (09-12), C4 (04-11), C4 II (11-15), C4 Picasso (06-12), C4 Grand Picasso (10-12), DS3 (09-12), DS4 (11-12), DS5 (12-15), C5 II (04-08), C5 III (04-12), Xsara II (02-04), Xsara Picasso (04-10)

UTENSILI OEM

FORD: 303-376B (1), 303-193 (2), 303-393 (3), 303-732 (4), 303-651 (5), 303-393/01, 303-1059, 303-734, 303-735,
MAZDA: 303-732, 303-734, 303-735.
PSA: 0194-A, 0194-C, 0194B.

CODICE MOTORE

1.4D TDCI/Hdi: DV4TD(8HT), DV4TD(8HX), DV4TD(8HZ), DV4TD(8HW), DV4TED4(8HX), DV4TED4(8HV), DV4TED4(8HY), DV4C(8HP), DV4C(8HR), DV4TED(8HS), F6JA, F6JB, F6JC.
1.6D TDCI/HDI: DV6TED4(9HZ), DV6ATED4(9HX), DV6TED4(9HY), DV6DTE(9HP), DV6C(9HR), DV6CATED(9HX), DV6C(9HL), DV6TED(9HP), DV6ATED(9HY), DV6TED4(9HV), DV6TED4(9HX), DV6C(9HD), DV6C(BHX), DV6C(BHZ), DV6(9HR), DV6BTED4(9HW), DV6DTE(9HJ), DV6ETED(9HN), DV6TED4BU(9HS), DV6BTED4(9HT), DV6BUTED4(9HT), DV6TED4B(9HV), DV6UTED4(9HX), DV6TED(9HD), DV6UTED4(9HU), DV6D(9HP), DV6TE-D4(9HV), DV6C(9HD), DV6TED4(9HW), DV6AT(9HX), DV6ATED(9HX), DV6CTED(9HC), DV6AUTED4(9HX), DV6TED4B, DV6DTE(9HF), HHJA, HHJB, G8DA, G8DB, HHDA, HHDB, MZ-CD, Y6.
1.8D TDCI/HDI: BHPA, C9DA/B, FFBA, G6DA, G6DB, G6DC, HCPA, HCBP, KKDA, P7PA, P9PA, R2PA, R3PA, RWPA.
1.8d: C9DC, RTN, RTQ.
1.8D Tdi: C9DA/B, C9DC.
2.0D TDCI/HDI: AZWA, G6DA, G6DB, G6DC, RHE(DW10CTED4), QXWA, QXWB.

KIT PER LA MESSA IN FASE DELLA DISTRIBUZIONE PER FORD

| | | | |
|----------------|------|---|-----|
| 51941 | 2,39 | 5 | 180 |
| 163,00€ | Kg | | |

Questo kit permette il corretto allineamento dell'albero a camme e dell'albero motore per il cambio della cinghia o la catena di distribuzione in motori a benzina e diesel.

MODELLO

FORD

Fiesta / Courier (00-00) Focus(98-00) Focus (04-08)
 Focus C-Max (03-08) Mondeo (07-08) Tourneo Connect (02-08) Transit connect (02-08), Fusion (02-08) S-Max (06-08) Galaxy (06-08)



ATTREZZO DI REGOLAZIONE CINGHIA DENTATA PER FORD 1.8TDDI / TDCI

53295 2,1 5 165
85,00€ Kg 5.6 11

diesel

MODELLO FORD C-Max (07-10), Courier (00-02), Fiesta (00-02), Focus (98-11), Focus C-Max (03-07), Galaxy (06-10), Mondeo (07-10), S-Max (06-14), Tourneo Connect (02-13), Transit Connect (02-13).

UTENSILI OEM 303-193 (21-104) (1), 303-393 (21-168) (2), 303-376 (21-162B) (3), 303-652 (21-230) (4), 310-095 (23-067) (5)

CODICE MOTORE
1.8D TDCi: BHPA, F9DA, F9DB, FFBA, FFDA, FFWA, HCPA, HCPB, KHBA, KKDA, KKDB, P7PA, P9PA, P9PB, QYBA, QYWA, R2PA, R3PA, RWPA, RWPC.
1.8D TDCi ECONetic: KHBA.
1.8D Tdi: BHDA, BHDB, BHDB, BHDB, C9DA, C9DB, C9DC.
1.8D Turbo: C9DC, RTN, RTP, RTQ.

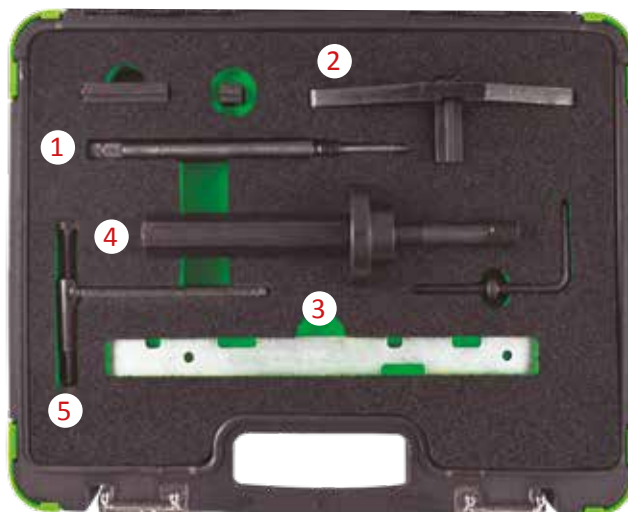

SET ATTREZZI PER MONTAGGIO E REGOLAZIONE POMPA CARBURANTE PER FORD / JAGUAR DURATORQ

53296 2,3 5 135
64,50€ Kg 5.6 11

diesel

MODELLO FORD: Mondeo (00-07), Transit (00-14).
CITROËN: Relay, Jumper III (06-13).
FIAT: Ducato (06-11).
JAGUAR: X-Type (03-10).
PEUGEOT: Boxer III (06-12).
LAND ROVER: Defender Td4 (06-11).
LDV: Convoy (02-06).

UTENSILI OEM 303-1151 (1), 303-679A/21-238 (2), 303-732 (3), 303-675/21-234 (4), 303-698/21-251 (5)

CODICE MOTORE
12.0D Di/TDDi/TDCi: ABFA, D3FA, F3FA, D5BA, D6BA, F1FA, FMBA, FMBB, HJBA, HJBB, HJBC, HJBE, N7BA, N7BB.
2.2D TDCi/ECONetic: BG, CYFA, CYFB, CYFC, DRFA, DRFB, DRFC, P8FA, P8FB, PGFA, PGFB, QJBA, QJBA (BG), QJBB, QJBC, QJBD, QVFA, QWFA, SRFA, SRFB, SRFC, SRFD, SRFE, UHFA.
2.2D HDi/JTD: P22DTE (4HM), P22DTE (4HU), P22DTE (4HV).
2.4D Di/TDCi: DOFA, D2FA, D2FB, D4FA, F4FA, FXFA, H9FA, H9FB, H9FD, JXFA, JXFC, PHFA, PHFC.
2.4D TD/Tdi: ZSD 424.
2.4D Td4: 244DT.

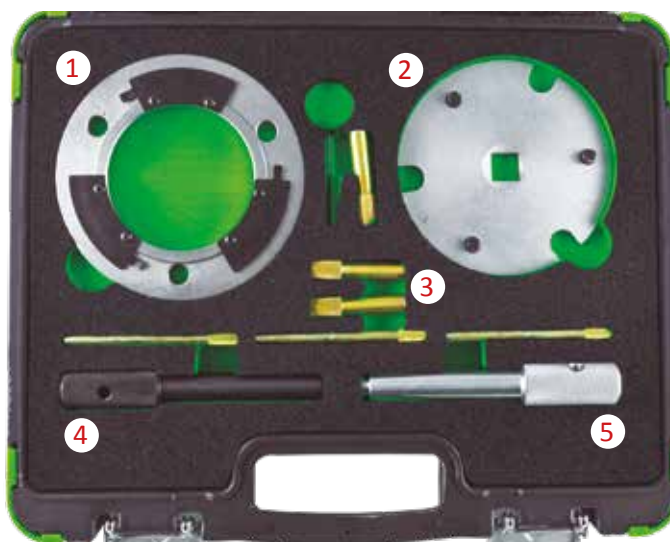

ATTREZZO DI REGOLAZIONE CINGHIA DENTATA PER JAGUAR / LAND ROVER

53297 1,2 10
49,00€ Kg 5.6 11

diesel

MODELLO JAGUAR: MS TypeTDVi.
LAND ROVER: Discovery 2.7 TDV6.
RANGE ROVER: Sport 2.7 TDV6.

UTENSILI OEM 303-1117 (1), 303-1116 (2), 303-1132 (3), 303-1126 (4) (5)

CODICE MOTORE 276DT, 306DT.

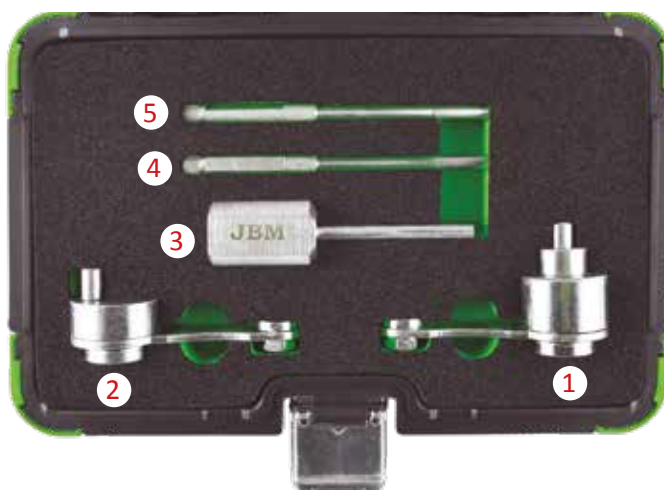

ATTREZZO DI REGOLAZIONE CINGHIA DENTATA PER LAND ROVER

| | | |
|---------------|-----|---|
| 53298 | 2,6 | 5 |
| 89,00€ | | |

MODELLO MOTORI DIESEL: 200 TDI. 300 TDI. 2.5

Perno di sincronizzazione trasmissione manuale EDC 200 TDI
2.5 Motori diesel
Estrattore dell'ammortizzatore dell'albero motore
Instrumenti di bloccaggio della pompa di iniezione
Bullone di sincronizzazione dalla pompa d'iniezione 200/300 TDI
Strumento di sincronizzazione del volante motore 200/300 TDI
Strumento di sincronizzazione della pompa DPS 2.5
Strumento di sincronizzazione del volante del motore 2.5



ATTREZZO DI REGOLAZIONE CINGHIA DENTATA PER OPEL / FORD / FIAT / ALFA ROMEO / LANCIA / SUZUKI

N

| | | | |
|---------------|------|----|-----|
| 53452 | 0,75 | 10 | 300 |
| 29,50€ | | | |

diesel

MODELLO VAUXHALL/OPEL 1.3 CDTi: Agila, Corsa, Combo(03-08),
Astra-H(05-08), Meriva, Tigra-B(04-08)
SUZUKI 1.3 DDiS: Ignis, Wagon R(03-08), Swift(04-08)
FORD: 1.3 TDCi
FIAT/ALFA ROMEO/LANCIA: 1.3 JTD Multijet

UTENSILI OEM 104-A EN 46781 , EN 46785



ATTREZZO DI REGOLAZIONE CINGHIA DENTATA PER OPEL / VAUXHALL / CHEVROLET 2.0CDI

| | | | |
|---------------|------|----|-----|
| 53300 | 1,25 | 10 | 270 |
| 44,00€ | | | |

diesel

MODELLO OPEL
VAUXHALL
CHEVROLET

UTENSILI OEM EN-48245 (1), EN-48246 (2), 205083060 (3) (4)
(5) (6)

CODICE MOTORE DIESEL 2.0 CDI

OPEL / VAUXHALL: Z20DM, Z20DMH
CHEVROLET: LLWZ20DMH, RA 420 , Z20SI, Z 20S3,
Z 20S4, Z 20S5

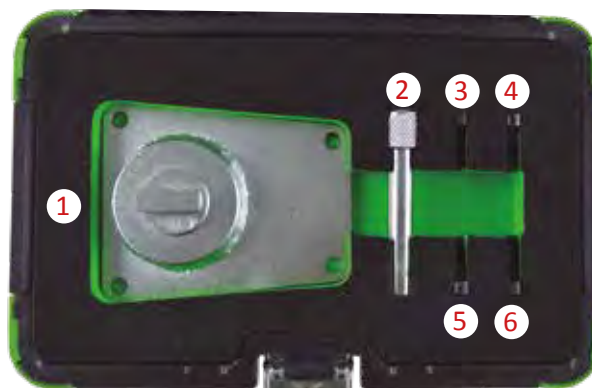

ATTREZZO DI REGOLAZIONE CINGHIA DENTATA PER OPEL / VAUXHALL

| | | | |
|----------------|-----|---|----|
| 53299 | 6,7 | 2 | 42 |
| 284,50€ | | | |

diesel

MODELLO OPEL / VAUXHALL

UTENSILI OEM EN-46788 (1), KM927 (2), EN-46789 (3), KM929
(4), EN-46785 (5), EN-46788 (6), 1 860 985
000 (7), KM932 (8), KM933 (9), EN-49978 (10),
KM933 (11)

CODICE MOTORE 1.3 CDTi 16V, 1.9 CDTi, 2.0 DTi, 2.2 DTi.



ATTREZZO DI REGOLAZIONE CINGHIA DENTATA PER OPEL 1.0 / 1.2 / 1.4

53301

| | |
|------|----|
| 1,15 | 10 |
| Kg | ft |

benzina

56,50€

MODELO

SUZUKI: Wagon R (05-08).
VAUXHALL / OPEL: Agila (00-08), Astra-G (98-06), Astra G Classic II (03-10), Astra-H (04-11), Combo (04-12), Corsa-B (97-00), Corsa-C (00-07), Corsa-D (06-12), Meriva-A (04-10), Tigra-B (04-10).

UTENSILI OEM

KM-953/09919-58310 (1), KM-952/09912-38310 (2), KM-954/09919-08310 (3), KM-6130 (4), KM-955/09919-58320 (5)

CODICE MOTORE

1.0 12v: X10XE, Z10XE, Z10XEP.
1.2 16v: X12XE, Z12XE, Z12XEP.
1.4 16v/ecoFLEX: Z14XEL, Z14XEP.

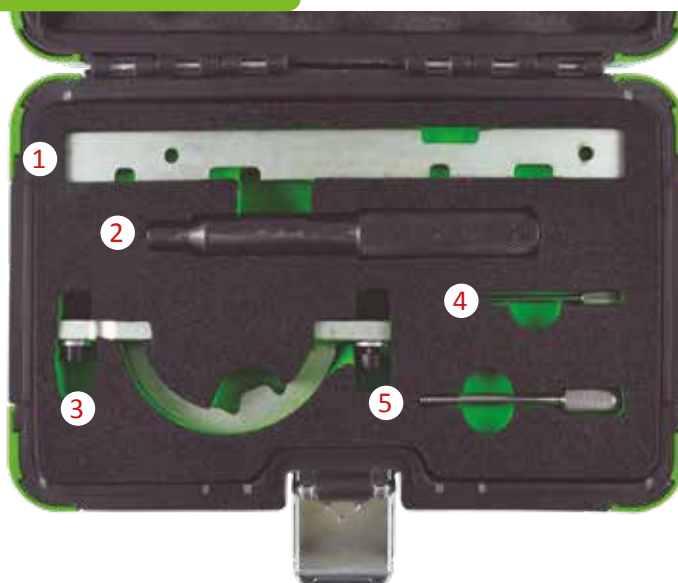

ATTREZZO DI REGOLAZIONE CINGHIA DENTATA PER OPEL / VAUXHALL ASTRA, VECTRA, ZAFIRA 1.9CDTI

53302

| | |
|-----|----|
| 1,1 | 10 |
| Kg | ft |

diesel

51,00€

MODELO

SAAB: 9-3 (04-08), 9-5 (05-08).
VAUXHALL / OPEL: Astra-H, Vectra-C, Signum (04-07), Zafira-B (05-07).

UTENSILI OEM

EN46789/32 025 008 (1) (3), EN46788/32 025 009 (2), KM6349 (4)

CODICE MOTORE

Z19DT, Z19DTH, Z19DTL.

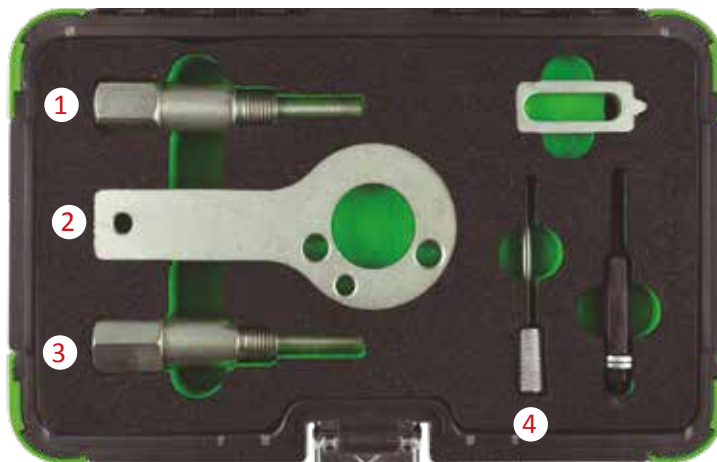

ATTREZZO DI REGOLAZIONE CINGHIA DENTATA PER FIAT / OPEL

53303

| | |
|----|----|
| 2 | 5 |
| Kg | ft |

diesel

143,00€

MODELO

FIAT: 1.9D/JTD (Motore Peugeot), 2.4D.
ALFA ROMEO: 145, 146, 156 JTD.
GM: GM 1.3, 1.6, 1.9, 2.0, 2.4 CDTi (2004 -).

UTENSILI OEM

EN-46789 (1), EN-46789-100 (2), EN-46785 (3), EN-46788 (4), EN-46781 (5), EN-46789 (6)

CODICE MOTORE

GM: K1.3 CDTi | Z13DT Common Rail engine.
1.9 CDTi / 04-12 - Z19DT | Z19DTH | Z19DTJ | Z19DTL
2.0 CDTi / 08-12 - A20DT | LBS / LBX / LBY / LCD.V
SAAB: 1.9 TiD.



KIT PER LA MESSA IN FASE DELLA DISTRIBUZIONE PER OPEL / VAUXHALL

| | | | |
|----------------|------|---|----|
| 51939 | 5,75 | 4 | 32 |
| 458,00€ | Kg | | |

diesel **benzina**

Valido anche per motori identici.
Ad esempio: SAAB, RENAULT

DIESEL

1.3 CDTI 16V, 1.9 CDTI, 2.0 DTI, 2.2 DTI

Agila, Astra, Combo-c, Corsa, Frontera, Omega, Signum, Sintra, Tigra, Vectra, Zafira.

BENZINA

1.0 12V, 1.2 16V (dall'anno 97), 1.4, 1.6, 1.8, 2.0, 2.2 16V (dall'anno 95)

Agila, Astra, Corsa, Tigra, Frontera, Omega, Sintra, Speedster, Vectra, Zafira.



ATTREZZO DI REGOLAZIONE CINGHIA DENTATA PER SAAB / OPEL / VAUXHALL

| | | | |
|----------------|-----|---|----|
| 53305 | 3,6 | 2 | 42 |
| 144,00€ | Kg | | |

benzina

| | |
|----------------------|--|
| MODELO | VAUXHALL / OPEL: Antara (06-10), Calibra (93-98), Cavalier/ Vectra-A (93-95), Omega-B (94-03), Signum (03-05), Sintra (96-99), Vectra-B (95-02), Vectra-C (02-05). SAAB: 900 (93-98), 9000 (95-97), 9-5 (98-03) |
| UTENSILI OEM | KM-800-1 (1), KM-800-2 (2), KM-800-20 (3), KM-800-10 (4), 83 95 006 (5), KM-800-30 (6), MKM-6038, 83 95 006 (7) |
| CODICE MOTORE | <u>2.5 V6:</u> Saab; B2581, Vauxhall/Opel; C25XE, X25XE. <u>2.6 V6:</u> Vauxhall/Opel; Y26SE. <u>3.0 V6:</u> Saab; B308E, B308i, Vauxhall / Opel; X30XE. <u>3.2 V6:</u> Vauxhall/Opel; Y32SE, Z32SE. |



ATTREZZO DI REGOLAZIONE CINGHIA DENTATA PER FIAT

| | | | |
|----------------|----|---|----|
| 53304 | 6 | 2 | 42 |
| 264,00€ | Kg | | |

diesel **benzina**

| | |
|----------------------|---|
| MODELO | FIAT |
| UTENSILI OEM | 1 860 874 000 (1), 1 860 895 000 (2), 1 860 898 000 (3), 1 860 905 000 (4), 1 860 845 000 (3) |
| CODICE MOTORE | MOTORE BENZINA: Fiat Brava , Bravo, Barchetta, Cargo, Coupe, Marea, Palio, Weekend, Punto, Multila, Stilo, Idea, Doblo Twin Cam Engines - 1.2, 1.4, 1.6, 1.8, 16V MOTORE DIESEL: Fiat Brava, Bravo, Marea, Weekend, Palio, Punto, Multitpla, Doblo, Ulysse, Ducato, Stilo JTD Diesel Engines - 1.9D/TD . 1.9JTD . 2.4TD/JTD. |

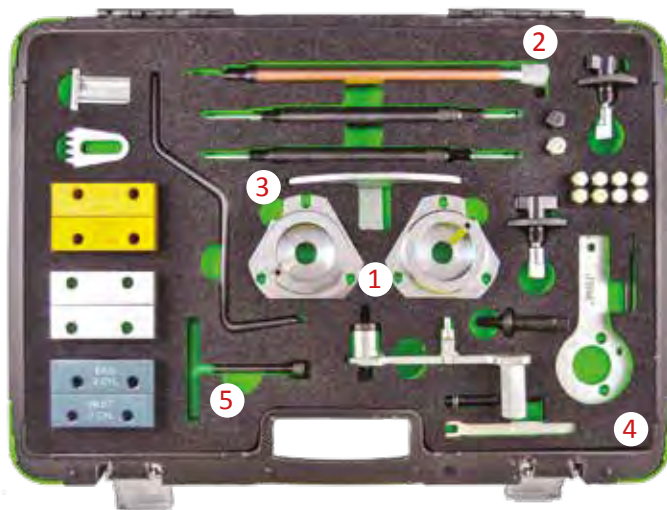

ATTREZZO DI REGOLAZIONE CINGHIA DENTATA PER FIAT 1.2 16V

| | | | |
|---------------|-----|----|-----|
| 53306 | 1,7 | 5 | 135 |
| 60,00€ | Kg | 1f | |

benzina



| | |
|----------------------|---|
| MODELLO | FIAT: Fiat 1.2L 16V, Fiat Punto / Brava / Bravo / Stilo |
| UTENSILI OEM | 1860992000 (1) (2), 1871000900 (3), 1860987000 (4), 186985000 (5) |
| CODICE MOTORE | 176 B9.000, 182 B2.000, 188 A5.000 |

ATTREZZO DI REGOLAZIONE CINGHIA DENTATA PER ALFA / OPEL / VAUXHALL 1.6 / 1.8 16V

| | | |
|---------------|----|----|
| 53307 | 1 | 10 |
| 42,50€ | Kg | 1f |

benzina

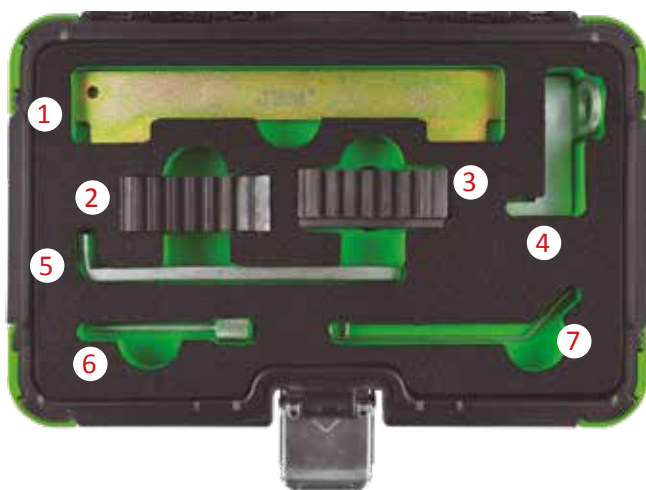

| | | |
|----------------------|---|---------------|
| MODELLO | OPEL / VAUXHALL: Corsa-D, Agila, Astra-G-H, Meriva, Zafira-B, Vectra-C, Signum, Insigna | 1.6, 1.8 |
| | CHEVROLET: Aveo, Cruze, Orlando | 1.4, 1.6, 1.8 |
| | ALFA ROMEO: 159 FIAT: Croma | 1.8 |
| UTENSILI OEM | E10290 (1), 23056-06 (2) (3), E10230 (4), 23164-04 (5), 23174-01 (6), 23056-05 (7) | |
| CODICE MOTORE | Opel / Vauxhall: Z16LEL, Z16LER, Z16LET, Z16XE1, Z16XEP, Z16XER, A16XER, 18XER, A18XER, 2HO / A18XEL. Chevrolet: G14D, LDD, LXV (F16D4), 2HO(Z18XER). Alfa / Fiat: 939A4.000. | |

ATTREZZO DI REGOLAZIONE CINGHIA DENTATA PER FIAT / OPEL / VAUXHALL 2.2 16V CATENA

| | | |
|---------------|-----|----|
| 53316 | 0,7 | 10 |
| 30,00€ | Kg | 1f |

benzina

| | |
|----------------------|--|
| MODELLO | OPEL: Astra-G (2000-2006), Astra-H (2006-2011), Signum (2003-2008), Vectra-B (2000-2002), Vectra-C (2002-2008), Zafira-A (2000-2005), Zafira-B (2005-2012), Speedster (2000-2006). VAUXHALL: VX220 (2000-2006). FIAT: Croma (2005-2009). |
| CODICE MOTORE | VAUXHALL / OPEL: Z22SE, Z22YH FIAT: 194A1.000. |



ATTREZZO DI REGOLAZIONE CINGHIA DENTATA PER ALFA ROMEO

| | | |
|---------------|------|----|
| 53308 | 1,15 | 10 |
| 58,00€ | Kg | |

benzina

| | |
|----------------------|--|
| MODELO | ALFA ROMEO: 145,146,147,155,156, 1.4 1.6 1.8 2.0 TS, 1.4/1.6 16V; 145/146/147/155/156 (96-10), 1.8 16V; 145/146, (96-01), 155/156 (96-06), Spider/GTV (98-05), 2.0 16V; 145/146 (96-01), 147 (01-10), 155/156 (95-02), 166 (98-07), Spider/GTV (96-05), Viola: 1.4, 1.6 // Blu: 1.8, 2.0 |
| UTENSILI OEM | 1822149000 (1), 1822154000 (2), 1825041000 (3), 1825042000 (4) |
| CODICE MOTORE | Z1.4/1.6-321.02, 321.03, 321.04, 335.03, 676.01 1.8/2.0-323.01, 672.04, 162.01, 323.10, 671.06, 322.01, 671.02, 322.05, 341.03, 363.01. |

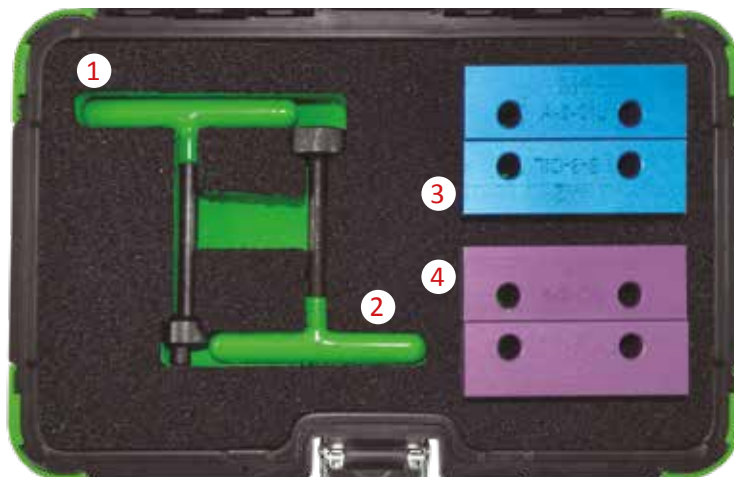

ATTREZZO DI REGOLAZIONE CINGHIA DENTATA PER ALFA / FIAT / LANCIA 1.4 / 1.6 / 1.8 / 2.0 16V

| | | | |
|----------------|-----|---|----|
| 53309 | 5,6 | 2 | 40 |
| 279,50€ | Kg | | |

benzina

| | |
|---------------------|---|
| MODELO | ALFA ROMEO: 145,146,147,155,156, 1.4 1.6 1.8 2.0 TS, 1.4/1.6 16V; 145/146/147/155/156 (96-10), 1.8 16V; 145/146, (96-01), 155/156 (96-06), Spider/GTV (98-05), 2.0 16V; 145/146 (96-01), 147 (01-10), 155/156 (95-02), 166 (98-07), Spider/GTV (96-05), Viola: 1.4, 1.6 // Blu: 1.8, 2.0 FIAT: Barchetta (96-00), Brava (95-00), Bravo (95-00), Coupe (96-01), Marea (96-00), Marea Weekend (96-00), Punto/Punto Classic (99-06), Stilo (01-08) LANCIA: Dedra (95-99), Delta (96-99), Kappa (98-02), Lybra (99-06). |
| UTENSILI OEM | 1.4 16v: 335.03 1.6 16v: 321.02, 321.03, 321.04, 372.03, 676.01 1.8 16v: 322.01, 322.05, 671.06, 182A2.000, 183A1.000, 183A6.000, 188A6.000, 192A4.000 2.0 16v: 162.01, 323.01, 323.1, 341.03, 363.01, 672.04 2.0 20v: 175A3.000, 182A1.000, 182B7.000, 185A8.000. |



ATTREZZO DI REGOLAZIONE CINGHIA DENTATA PER FIAT / ALFA / LANCIA

| | | | |
|----------------|------|---|----|
| 53310 | 10,7 | 2 | 40 |
| 468,50€ | Kg | | |

benzina

| | | |
|----------------------|---|---|
| MODELO | ALFA FIAT LANCIA | Alla, Barchetta, Bravo, Brava, Coupe, Delta, Dedra, Punto, Spider, GT |
| UTENSILI OEM | 1860845000 (1), 1822154000 (2), 1860905000 (3), 1860992000 (4), 1860895000 (5), 1860874000 (6), 1860985000 (7), KM571A (8), 1.860.896.000 (9), 0153A (10) | |
| CODICE MOTORE | 1.2 / 16V, 1.4 / 12V, 1.6 / 16V, 1.6 eco. 1.8, 2.0 / 16V, 2.0 / 20V, 2.4 / 20V, 3.0 / V6. | |



ATTREZZO DI REGOLAZIONE CINGHIA DENTATA PER RENAULT / NISSAN / OPEL / VAUXHALL 2.0 / 2.3 DCI / CDTI M9R / M9T

53311
107,00€

| | | |
|------|---|-----|
| 2,15 | 5 | 135 |
| | | |

diesel

MODELO

NISSAN: Primastar X83 (06-15), Qashqai/Qashqai+2 J10 (07-14), X-Trail T31 (07-14).
VAUXHALL/OPEL: Movano-B (10-17), Vivaro (06-15).
RENAULT: Espace/Grand Espace IV (06-10), Koleos (08-15), Laguna II (05-07), Laguna III (07-14), Master III (10-15), Megane II (06-10), Scenic/Grand Scenic II (06-09), Scenic/Grand Scenic III (09-15), Trafic II (06-14), Vel Satis (05-10)

UTENSILI OEM

Mot1769 (1), EN-48334 (2), Mot1766 (3), EN-48330 (3), KM-6130 (4), EN-48332 (5), Mot1773 (6), EN-48831 (6)

CODICE MOTORE

2.0D dCi M9R: 630, 780, 782, 784, 786, 788, 830, 832, 833, 834, 835, 836, 838, 855, 856.
2.0D CDTI M9R: 630, 780, 782, 784, 786.
2.3 Bi-CDTI: LP6/M9T706, LW7/M9T706.
2.3D dCi M9T: 670, 672, 676, 678, 680, 686, 690, 692, 694, 698.



ATTREZZO DI REGOLAZIONE CINGHIA DENTATA PER FIAT / ALFA / FORD

53312
145,50€

| | |
|-----|---|
| 2,6 | 5 |
| | |

benzina

MODELO

FIAT: New 500 (07-09), Idea (04-09), Linea (07-09), Grande Punto (07-09), Doblo 1 Cargo (05-09), Panda EV02 (05)
FORD: KA 1.2 Duratec (09)
ALFA ROMEO

UTENSILI OEM

1 860 987 000 (1), 2 000 004 400 (2), 2 000 015 800 (3), 2 000 004 300 (4), 2 000 004 500 (5)

CODICE MOTORE

1.2: 169A4.000 / 199A4.000 .
1.4: 350A 1.000 / 188A4.000-EV02.



ATTREZZO DI REGOLAZIONE CINGHIA DENTATA PER CITROËN / PEUGEOT

53313
153,00€

| | | |
|------|---|----|
| 4,55 | 2 | 40 |
| | | |

diesel

benzina

MODELO

CITROËN: AX, BX, Boxer, Berlingo, C25, Dispatch, Evasion, J5, Jumpy, Jumper, Relay, Saxo, Synergie, Visa, XM, Xsara, Xantia, XZ, ZX.
PEUGEOT: 106, 205, 206, 305, 306, 307, 309, 405, 406, 605, 607, 806, Expert, Partner, Solara, Talbot.

UTENSILI OEM

7099TM (1), 0188X (2), 0188P (3), 0189AZ (4), 0188H (5), 0132AJ1 (6), 0189A (7), 0188PM (8), 21-260 (9), 4527-TS1 (10), M8X70 (11), 0188K (12), 0188I (13), 0132Q (14), 4507-TL (15), 4507-TJ (16), 9044-T (17), 4507-TJ (18), 5711-TA (19), 7014-TJ (20), 7017-TR (21), 0188X (22), 7017-TW (23), 7014-TM (24), 0189L (25)

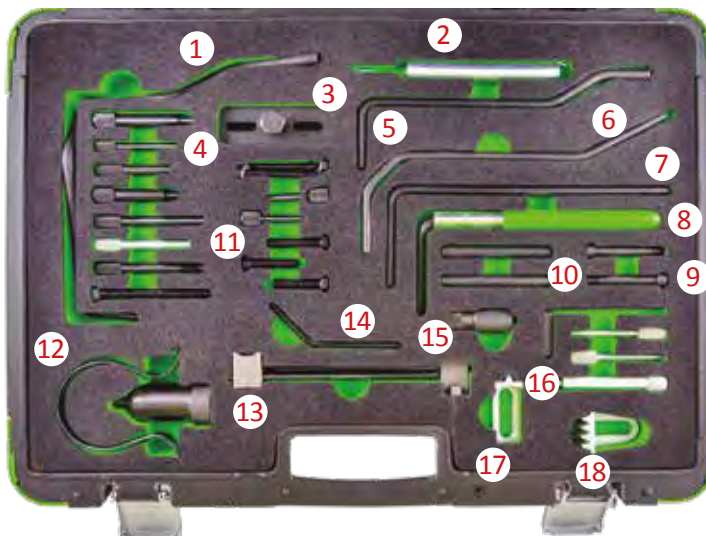

ATTREZZO DI REGOLAZIONE CINGHIA DENTATA PER CITROËN / PEUGEOT 1.8 / 2.0

| | | |
|---------------|------|----|
| 53314 | 1,85 | 2 |
| 99,00€ | Kg | 11 |

benzina

| | |
|----------------------|---|
| MODELLO | CITROËN: C4 Picasso/Grand Picasso (06-10). C5 II (04-08), C8 (05-10), Dispatch/Jumpy (07-11), Xsara 2.0 16v, C5 1.8/2.0/HPI, Xsara Picasso 1.8/2.0 16v (02-05) PEUGEOT: 406 1.8 16v (00-04), 407 (06-10). 807 2.0 16v (02-05). |
| UTENSILI OEM | 0189S2 (1), 0188I (2), 0188J2 (2), 0189S1 (3), 21-260 (4), 0189B (5), 0188M (6), 0188AH (7), 0189R (8) |
| CODICE MOTORE | <u>1.8 16v</u> : EW7A(6FY). <u>2.0 16v</u> : EW10A(RFJ), EW10ABE4(RFH), EW10J4S (RFK). |

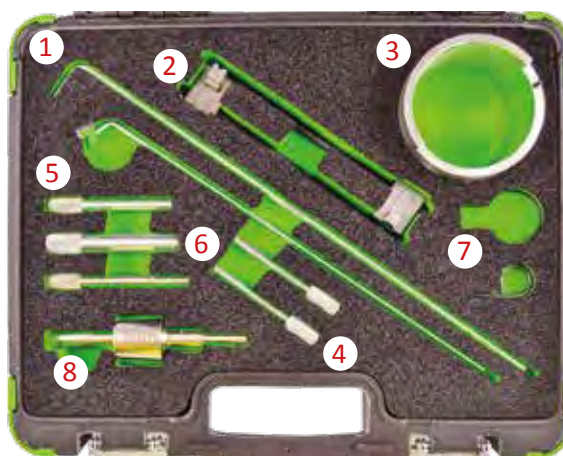

KIT PER LA MESSA IN FASE DELLA DISTRIBUZIONE PER CITROËN

| | | | |
|----------------|------|----|----|
| 51944 | 4,21 | 2 | 64 |
| 394,00€ | Kg | 11 | 11 |

| | |
|----------------------|---|
| MODELLO | CITROËN: AX, BX, ZX, XM, Saxo, Xsara, Xantia, Synergie, Evasion, Berlingo, Dispatch, Jumpy, C15, Relay/Jumper, Synergie, C5 (2000-2002), C8 RENAULT |
| CODICE MOTORE | <u>Motori a benzina</u> : 1.0, 1.1, 1.4, 1.6, 1.8, 1.9, 2.0 <u>Motori turbo e a doppio albero a camme</u> : 1.6, 1.8, 2.0, 2.2 16V <u>Motori diesel</u> : 1.4, 1.6, 2.0, 2.2 HDi, 1.5D a 2.5D |



ATTREZZO DI REGOLAZIONE CINGHIA DENTATA PER FIAT / PEUGEOT / CITROËN 2.3D JTD 3.0 JTD / Hdi

| | |
|---------------|-----|
| 53319 | 0,6 |
| 34,50€ | 10 |
| | 60 |

diesel

| | |
|----------------------|---|
| MODELLO | FIAT: 2.3 / 3.0 JTD. IVECO: Daily. |
| UTENSILI OEM | 99360614, 1 860 617 000, 99360615, 2 000 018 200. |
| CODICE MOTORE | F1AE0481C, F1AE0481D, F1AE0481N, F1CE0481A/D. |



ATTREZZO DI REGOLAZIONE CINGHIA DENTATA PER VOLVO 3.0 / 3.2T6 FREELANDER2 3.2I

| | | | |
|----------------|------|----|----|
| 53315 | 7,15 | 2 | 42 |
| 279,50€ | Kg | 11 | 11 |

benzina

| | |
|----------------------|---|
| MODELLO | VOLVO: S60 (10-16), S80 (07-15), XC60 (08-15), XC70 (06-15), XC90 (10-14), V60 (10-15), V70 (10-15). LAND ROVER: Freelander II (11-14). |
| UTENSILI OEM | VOLVO: 999-7263 (3), 999-7264 (1), 999-7272 (5), 999-7257 (2), 999-7261 (4). LAND ROVER: 303-1225 (3), 303-1226 (1), 303-1219 (2), 303-1223 (4). |
| CODICE MOTORE | <u>3.0 Turbo</u> : B6304T2, B6304T4. <u>3.2</u> : B6324S, B6324S5. <u>3.2i6</u> : B6324S. |

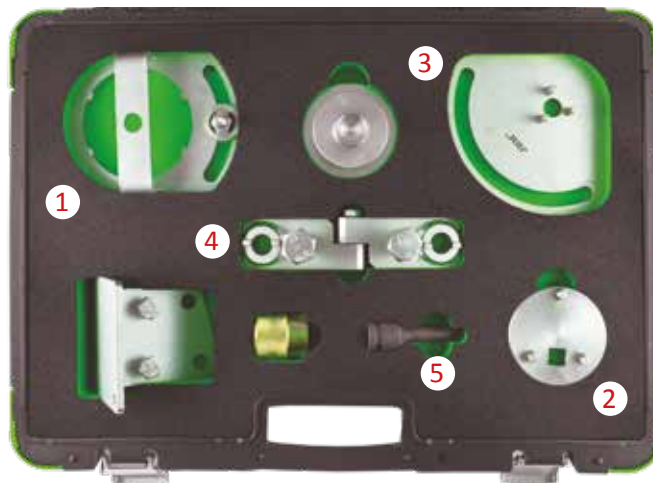

CHIAVE UNIVERSALE PER ALBERO A CAMME + ADATTATORI

| | | | |
|---------------|------|----|-----|
| 51340 | 2,15 | 6 | 200 |
| 39,50€ | Kg | ff | ff |

Contenuto:

Chiave di 25 cm di diametro di apertura e 52 cm di lunghezza
4 set di 2 bulloni adattatori di 4 misure
1 set di 2 dadi con filettatura di 1 cm di diametro



ESTRATTORE RUOTA DENTATA DI ALBERO A CAMME PER FORD

| | | |
|---------------|-----|----|
| 53318 | 0,4 | 20 |
| 25,50€ | Kg | ff |

diesel

MODELO FORD

APPLICABILE PER I MOTORI F8M, F8Q, S8U, S9U.



KIT DI BLOCCAGGIO DELL'ALBERO A CAMME

| | | | |
|---------------|------|----|-----|
| 51841 | 0,76 | 10 | 120 |
| 76,50€ | Kg | ff | ff |

Range di apertura:
0 - 60mm



KIT DI BLOCCAGGIO DELL'ALBERO A CAMME

| | | | |
|---------------|------|----|-----|
| 51348 | 0,99 | 20 | 150 |
| 38,00€ | Kg | ff | ff |

Una raccolta degli utensili di bloccaggio più popolari per alberi a camme, alberi motore e pulegge del volano.



Contenuto:

A - Corona di registrazione del motore e dispositivo di bloccaggio.
B - Utensile di bloccaggio dell'albero a camme.
C - Utensile di bloccaggio dell'albero a camme.

D - Utensile di bloccaggio dell'albero a camme.

E - Utensile di bloccaggio dell'albero a camme.
F - Utensile di bloccaggio dell'albero a camme.
G - Utensile ruota libera.
H - Utensile di bloccaggio speciale per Volkswagen.

REGGISPINTE PER ALBERO A CAMME VAG 1.8 / 2.0 TFSI

| | | | |
|---------------|------|----|----|
| 53323 | 0,15 | 18 | 36 |
| 10,00€ | Kg | sb | ff |

benzina

MODELO

AUDI: A3, A4, A5, Q5 1.8.
VW: 2.0 Catena.

UTENSILI OEM

T10352, T10352/1.

CODICE MOTORE

1.8 / 2.0



ATTREZZO PER FISSAGGIO ALBERO A GOMITI CON PIASTRA IN ACCIAIO

| | | | |
|---------------|------|----|----|
| 53320 | 0,15 | 10 | 40 |
| 12,00€ | Kg | sb | ff |

diesel

MODELO

SEAT: Alhambra, Altea, Arosa, Cordoba, Ibiza, Leon, Toledo 1.4/1.9/2.0 TDI.
VW: Passat 1.9.
AUDI: A4/A6 1.9.

UTENSILI OEM

T10008, T20102, T10100.



SET DI BLOCCAGGIO DELL'ALBERO A CAMME

| | | | | |
|---------------|------|----|----|-------|
| 51489 | 0,35 | 10 | 40 | 2.250 |
| 10,00€ | Kg | sb | ff | ff |

benzina

Facile da usare per il bloccaggio delle pulegge dell'albero a camme durante la sua manutenzione.

MODELO

VW: Lupo 99, Polo 95, Caddy 96, Polo Classic, Variant 96, Beetle 1.4L 99, Golf 1.4L, 1.6L 98 y 1.4L, Bora, 1.6L 99.
AUDI: A2.

UTENSILI OEM

T10016.

CODICE MOTORE

1.4 / 1.6 16V



DISPOSITIVO BLOCCAGGIO ALBERO MOTORE / ALBERO

| | | | | |
|---------------|------|----|-----|-------|
| 51488 | 0,25 | 20 | 100 | 2.250 |
| 21,00€ | | | | |

Perni di sicurezza per il complessivo albero a camme e albero motore per Renault con motori diesel e a benzina.

Consigliato per il bloccaggio del motore durante il cambio o la manutenzione del complessivo dell'albero a camme.

| | |
|----------------------|---|
| MODELO | RENAULT (diesel): Modus, clio, R19, Megane, Scenic, Express, Rapid, Trafic 1.5 dCi/1.9D/1.9TD1.9dTi OPEL: Laguna, Espace NISSAN: Kangoo, Extra, Express. |
| UTENSILI OEM | MOT1489, MOT1430, MOT1054. |
| CODICE MOTORE | K9K, F8Q, F9Q - benzina, Clio, R19, Laguna 1.8/2.0 F3R F3P |



DISPOSITIVO BLOCCAGGIO ALBERO MOTORE / ALBERO

| | | | |
|---------------|------|----|-----|
| 51482 | 1,12 | 20 | 300 |
| 64,00€ | | | |



| | |
|----------------------|---|
| MODELO | AUDI: A4, A6, A8, Allroad (97-04) VW: Passat (98-04) |
| CODICE MOTORE | AFB, AKE, AKN, AYM, BAU, BCZ, BDG, BDH, BFC |

KIT TENDICINGHIA UNIVERSALE

| | | | |
|----------------|------|----|-----|
| 51486 | 1,37 | 10 | 200 |
| 118,50€ | | | |

Motori: Alfa Romeo, Fiat, Citroën, Peugeot, Renault, VH

Un'ampia gamma di leve tendicinghia e chiavi necessarie per la sostituzione della cinghia di distribuzione dei motori a benzina e diesel più popolari.



KIT PER LA MESSA IN FASE DELLA DISTRIBUZIONE PER BMW

| | | | |
|---------------|------|----|-----|
| 51485 | 1,39 | 16 | 180 |
| 54,00€ | | | |

Questo kit permette un corretto bloccaggio della distribuzione per motori MMN, M47 2.0 16.

Motori: (E469), 318D, 320D, 330D, (E39), 520D, 525D, 530D, (E38) y 730D.



KIT PER LA MESSA IN FASE DELLA DISTRIBUZIONE PER SEAT / AUDI / VAG / SKODA

| | | | | |
|----------------|------|---|----|-----|
| 51487 | 0,43 | 5 | 40 | 320 |
| 208,00€ | | | | |
| | 4 | | | |
| | 5 | | | |
| | 60 | | | |

diesel

benzina



Adatto per il cambio della cinghia in modelli recenti e antichi, dall'1.9D del 1976.

| | | | |
|---------------|---|----------------------|---|
| MODELO | AUDI: A4, A6, A8, Allroad (97-04) VW: Passat (98-04) | CODICE MOTORE | AFB, AKE, AKN, AYM, BAU, BCZ, BDG, BDH, BFC |
|---------------|---|----------------------|---|

UTILE PER LA MESSA IN FASE DELLA DISTRIBUZIONE VAG

| | | | | |
|---------------|------|---|----|-----|
| 52271 | 0,43 | 5 | 40 | 320 |
| 21,00€ | | | | |



MODELO
AUDI: A2 1.4TDI (02-06), A3 1.9, 2.0TDI (02-08), A4 1.6TDI (02-05), A4 1.9, 2.0TDI(04-08), A6 1.9TDI (02-05).
SEAT: Altea 1.9SDI/TDI (05-08), Leon 1.9.2.0TDI (05-08), Toledo 1.9SDI/TDI (05-08).
SKODA: Fabia 1.4TDI (03-06), Octavia II 2.0TDI (03-06)
VW: Beetle 1.9TDI (02-08), Bora 1.9TDI (02-08), Fox 1.4TDI (02-08), Golf 1.9, 2.0TDI (02-08), Lupo 1.4TDI (02-08), Polo 1.4, 1.9TDI (02-08), Sharan 1.9TDI (02-08).

CODICE MOTORE
AUDI: AMF, ASZ, ATD, AVB, AVF, AWX, AXR, AZV, BHC, BKC, BKD, BKE, BLB, BMN, BNA, BPW, BRB, BR, BRD, BRE, BRF, BUY, BVA, BVF, BVG.
SEAT: BJB, BKC, BLS, BMM, BXE
SKODA: AMF, AZV, BKD
VW: AJM, AMF, ANU, ARL, ASZ, ATD, AUY, AVB, AVF, AWX, AXR, BAY, BMS, BNM, BNV, BWW

KIT DI SMONTAGGIO E MESSA IN TENSIONE DI CINGHIE POLY-V

| | | | |
|---------------|------|----|-----|
| 51927 | 0,65 | 20 | 640 |
| 37,50€ | Kg | | |



Per montare/smontare ed estrarre facilmente le nuove cinghie POLY-V.
 - Adatto per PSA e motori Ford Fiesta 1.4/1.6, Citroën C4, Peugeot 307, Fiat Doblo, Dacia Logan.
 - Utensile indispensabile per uso professionale.
 - Senza un punto di presa preciso non è possibile smontare ed estrarre le cinghie adeguate per questo utensile.

TENSIOMETRO PER CINGHIA DI DISTRIBUZIONE

| | | | | |
|---------------|------|----|----|-----|
| 52616 | 0,35 | 10 | 40 | 800 |
| 41,50€ | Kg | | | |

Due misure di regolazioni con lettura anteriore e posteriori.



CHIAVE PER PULEGGIA DENTATA 32 mm PER VW / AUDI 2.5 TDI

| | | | |
|--------------|-----|----|-----|
| 53325 | 0,1 | 20 | 100 |
| 6,50€ | Kg | | |

benzina



MODELLO AUDI: 100 ('91-), A6 (2.5 TDI) 2.3, 2.4, 2.5, 2.8, 2.9D TDI (1991-2003)
 VW: LT, Transporter

UTENSILI OEM 3355

CODICE MOTORE AAB, AAT, ACU, ACV, AEL, AET, AGX, AHG, AHY, AJA, AJT, ANJ, APA, APL, AUF, AVT, AXG, AXL, AYC.

CHIAVE REGOLAZIONE TENSIONAMENTO CINGHIA PER VW / AUDI

| | | | |
|---------------|------|----|----|
| 53321 | 0,25 | 10 | 50 |
| 10,50€ | Kg | | |

benzina



MODELLO AUDI: A4/1.8T,2.0 1999-2004 A6/1.8T 2002-2004 A4/3.0 (2002 -), A6/3.0 (2002 -), A8/7.0 (2003 -).
 VW: Golf Passat 2.0 TDI DIESEL, Golf 88-97, Passat 92-97, VW T4/2.0 1992-2004.

UTENSILI OEM T10020.

TENDICINGHIA DELLA DISTRIBUZIONE SPECIALE PER BMW MINI COOPER

| | | | |
|---------------|------|----|-----|
| 51135 | 1,56 | 10 | 400 |
| 70,50€ | Kg | | |



SUPPORTO RUOTA DENTATA DELLA POMPA DEL SISTEMA DI RAFFREDDAMENTO

| | | |
|---------------|------|----|
| 53317 | 0,64 | 12 |
| 31,00€ | Kg | |

diesel

MODELLO OPEL 2.2 Catena
 VAUXHALL 2.2 Catena

Utilizzato per lasciare il motore in posizione allineata durante la sostituzione della pompa dell'acqua.
 Permette di sostituire la pompa senza modificare la posizione della catena di distribuzione.



BUSSOLE 1/2" MERCEDES

| | | | |
|---------------|------|---|----|
| 52819 | 0,24 | 5 | 72 |
| 26,50€ | Kg | | |

1/2" MERCEDES





ACCESSORI LUBRIFICANTI

| | |
|---------------------------------|-----|
| SERBATOI DI STOCCAGGIO. | 192 |
| RACCOGLITORE DI OLIO. | 193 |
| CARRELLO PORTABIDONI | 193 |
| POMPE DI ESTRAZIONE | 194 |
| POMPE | 196 |
| VASCA RACCOLTA LIQUIDI. | 196 |
| IMBUTI | 197 |



SERBATOI DI STOCCAGGIO PER FUSTI

Rivestimento sfoderabile / Spill fisso Pallet / Rimuovere il bidone prima di utilizzare il carrello elevatore / Facilità di trasporto. Adatto all'utilizzo con la maggior parte dei carrelli elevatori e pallet / Realizzata in polietilene (PE) riciclabile al 100%

Portata 400 kg

| | | | |
|----------------|-------|---|---|
| 52804 | 19,50 | 1 | 5 |
| 268,50€ | Kg | | |

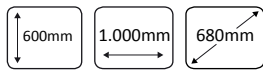

VASCA DI RACCOLTA
1 FUSTO VERTICALE

230L



Portata 650 kg

| | | | |
|----------------|----|---|---|
| 52805 | 31 | 1 | 5 |
| 319,00€ | Kg | | |

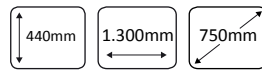

VASCA DI RACCOLTA
2 FUSTI VERTICALI

250L

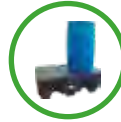

Non adatto per transpallet

Portata 1.250 kg

| | | | |
|----------------|----|---|---|
| 52806 | 30 | 1 | 5 |
| 511,50€ | Kg | | |

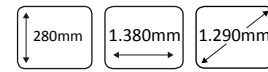

VASCA DI RACCOLTA
4 FUSTI VERTICALI

250L



DIBT APPROVATO

SERBATORI DI STOCCAGGIO PER FUSTI SPECIALE EUROPALLET 2 FUSTI

| | | | |
|----------------|------|---|----|
| 53214 | 16,5 | 1 | 12 |
| 247,50€ | Kg | | |

230L/650Kg

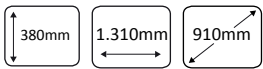

Per 2 fusti.

Compatibile con l'Euro pallet (1200 mm x 800 mm) e pallet in plastica con dimensioni simili.

Impilabile per il trasporto e lo stoccaggio economico.

Può essere utilizzato con la sua griglia o posizionare l'euro pallet direttamente sopra il secchio per ridurre i costi.

I pallet caricati possono essere collocati / rimossi dal bidone con o senza la griglia per carrello elevatore.

Bidone con bassa altezza adatto per il lavoro.

Capacità in linea con le norme europee, inglesi e americane.

Può essere gestito da carrello elevatore o pallet dai 4 lati o transpallet sui 2 lati quando è vuoto.

In polietilene - riciclabile al 100%.



CONTAINER IBC 1.000L

| | | |
|------------------|------|---|
| 52807 | 82,5 | 1 |
| 1.319,00€ | Kg | |

Portata 2.500 kg

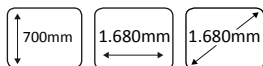

Impilabile, risparmio spazio, innovativo.

Altezza ridotta (700 mm) per un facile utilizzo.

Ampia area di lavoro (2,5 m).

Piattaforma con accesso per le mani e fori d'ispezione e per inserimento bombole.

Facilità di trasporto. Compatibile con la maggior parte dei carrelli elevatori e pallet.

100% PE riciclabile, resistente ai raggi UV.



DIBT APPROVATO

RACCOGLITORE DI OLIO

| | | | |
|----------------|------|---|---|
| 53109 | 19,5 | 1 | 6 |
| 219,00€ | Kg | | |

80L

| | | |
|---------------|-------|-------|
| 1,02m - 1,65m | 500mm | 400mm |
|---------------|-------|-------|

Caratteristiche:

Capacità extra di 10 litri di raccolta colino.
Altezza regolabile in collezione: 1m. min/1,65m massimo.
Base con 2 ruote fisse e 2 ruote mobile.
Compreso maniglia per il trasporto incluso.
Tubo di drenaggio con 130cm con impugnatura in gomma.
Ingresso aria 1/4" per facilitare lo svuotamento grazie alle pressioni.
Pressione massima 8 BAR.
Valvola di sicurezza incluso.

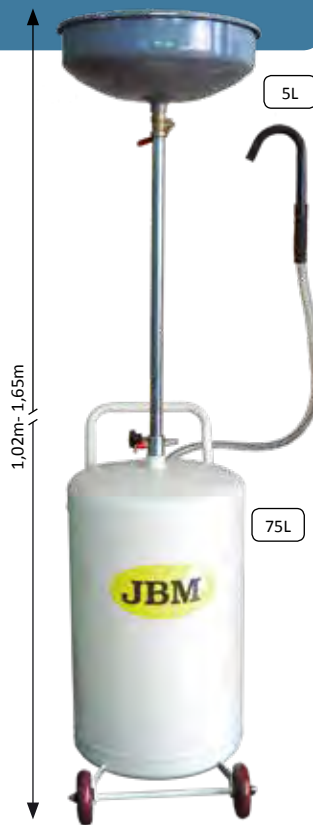

CARRELLO PORTABIDONI

| | |
|----------------|----|
| 50924 | |
| 219,00€ | |
| | 31 |
| | 1 |
| | 7 |



RUOTA GIREVOLE



Per bidoni dell'olio da 200L.

11321 RUOTE GIREVOLI
20,50€ PER REF. 50924

11320 KIT DI RUOTE
LATERALI FISSO
14,00€ PER REF. 50924

CHIAVE PER BIDONI OLIO

| | | | | |
|--------------|------|---|----|-------|
| 52452 | 0,12 | 6 | 60 | 1.080 |
| 7,50€ | Kg | | | |

Materiale: Nylon.
Anti-scintilla e anti-polvere.
Rilievi in 3/4" e 2".
Utile per fusti da 200L.

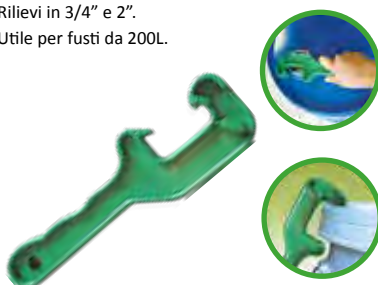

TAPPO PER BIDONE DI 200L

| | |
|---------------|------|
| 53078 | |
| 16,00€ | |
| | 0,25 |
| | 5 |
| | 25 |
| | 300 |



RACCOGLITORE DI OLIO CON SISTEMA DI ASPIRAZIONE

| | |
|----------------|--|
| 53223 | |
| 318,00€ | |

| | |
|--|----|
| | 26 |
| | 1 |
| | 12 |

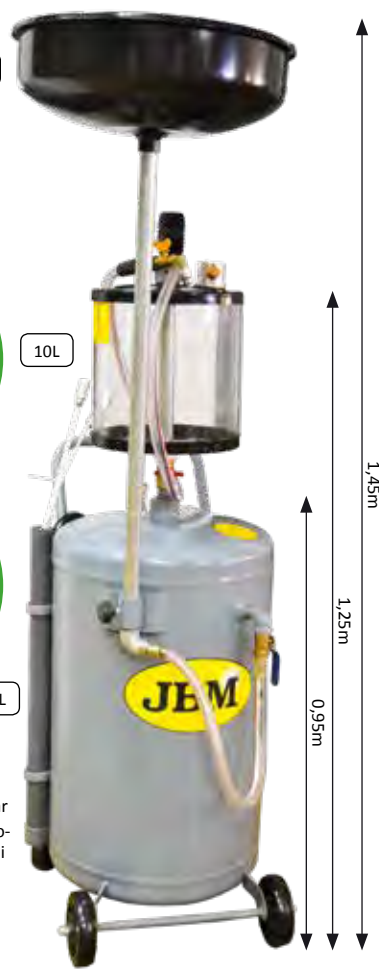

Livello del vuoto: negativo 0-0,8 bar
Pressione di esercizio: 6-8 bar
Vaso, capacità del recuperatore d'olio: 10 lt (con sistema di misura oculare)
Capacità del recipiente di stoccaggio: 75lt+10lt+5lt
Ambiente: olio, olio per riduttori
Peso netto: 29 kg
Velocità di aspirazione: 0,6 lt/min (5 mm); 1,6 lt/min (8 mm);

TUBO DI RICAMBIO

| | | |
|--------------|--------------|-----|
| 14014 | 5,00€ | 4mm |
| 14015 | 5,00€ | 6mm |
| 14016 | 5,50€ | 8mm |

RACORD

13925 **6,50€**

DEPOSITO

13926 **118,50€**

MANOMETRO

13307 **13,00€**

TUBO FLESSIBILE

13306 **34,00€**

RUBINETTO DA 3/4" PER BIDONE OLIO PER FUSTI DA 200L

| | | | | |
|---------------|------|---|-----|-------|
| 52453 | 0,19 | 5 | 100 | 1.000 |
| 19,00€ | Kg | | | |

Rubinetto di sicurezza
Filo 3/4"
Lega e nylon
Aplic. oli, lubrificanti, benzina, gasolio, cherosene e ADBLue



RUBINETTO PLASTICO DE 3/4"

| | |
|--------------|-------|
| 53518 | |
| 2,00€ | |
| | 0,05 |
| | 10 |
| | 500 |
| | 3.000 |

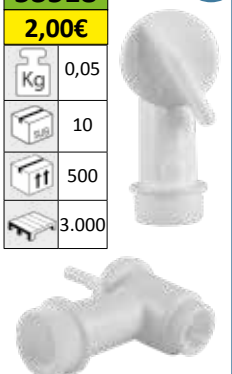

POMPA DELL'OLIO PER BIDONE

52601

| | | |
|-----|---|----|
| 9,1 | 2 | 30 |
| | | |

200L

Rapporto di pressione: 5:1
 Entrata d'aria: 1/4"
 Uscita d'aria: 1/4"
 Pressione di funzionamento:
 6-8bar
 Pressione massima: 8 bar
 Consumo d'aria: 250 l/min
 Capacità relativa a 6 bar:
 18 l/min
 Range della temperatura
 dell'olio: -10 ~ 50 °C
 Viscosità massima dell'olio:
 240 SAE
 Lunghezza

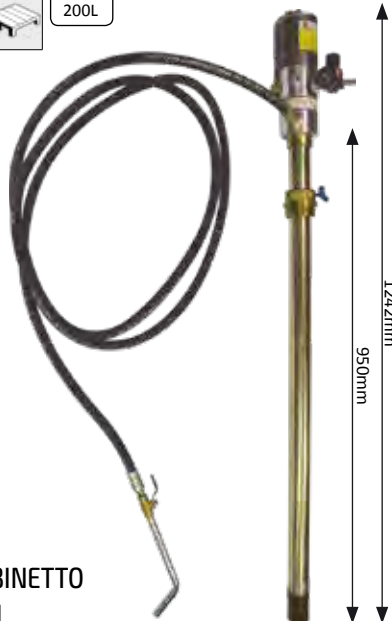

12056

TUBO CON RUBINETTO
 49,00€ PER REF. 52601

POMPA DELL'OLIO

50918

292,50€

| | |
|--|------|
| | 7,25 |
| | 1 |
| | 34 |

200L

Rapporto di pressione: 5:1
 Entrata d'aria: 1/4"
 Uscita d'aria: 1/2"
 Pressione di funzionamento: 6 - 8 bar
 Pressione massima: 8 bar
 Consumo d'aria: 250 l/min
 Capacità relativa a 6 bar: 18 l/min
 Range della temperatura dell'olio: -10 ~ 50 °C
 Viscosità massima dell'olio: 240 SAE
 Lunghezza del tubo metallico: 950 mm

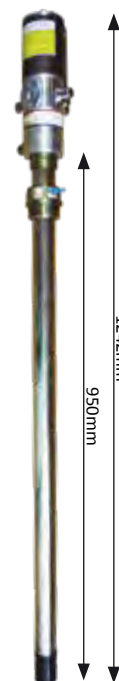

PISTOLA EROGATRICE CON CONTALITRI DIGITALE

50917

279,50€

| | | |
|------|----|----|
| 2,15 | 10 | 50 |
| | | |

Entrata d'aria: 1/2"
 Range di portata: 1-35 L/min
 Pressione di funzionamento: 6 - 8 bar
 Range della temperatura dell'olio: -10~60 °C
 Viscosità massima dell'olio: 240 SAE
 Peso: 1,4Kg



PILA INCLUSA

10000 **8,00€**

PILE DI RICAMBIO
 PER 50917



KIT DI POMPA DELL'OLIO + TUBO + PISTOLA EROGAZIONE OLIO DIGITALE

50935

544,50€

| | | |
|------|---|----|
| 10,7 | 1 | 20 |
| | | |

Rapporto di pressione: 5:1
 Entrata d'aria: 1/4"
 Uscita d'aria: 1/2"
 Pressione di funzionamento: 6 - 8 bar
 Pressione massima: 8 bar
 Consumo d'aria: 250 l/min
 Capacità relativa a 6 bar: 18 l/min
 Range della temperatura dell'olio: -10 ~ 50 °C
 Viscosità massima dell'olio: 240 SAE
 Lunghezza del tubo flessibile: 2 m
 Lunghezza del tubo metallico: 950 mm

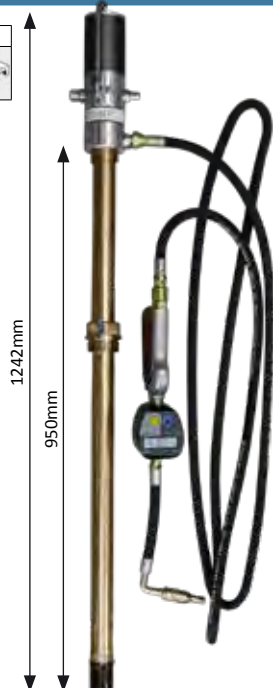

POMPA A PARETE PER SERBATOIO DA 1.000L

51058

547,00€

| | | |
|------|---|----|
| 4,68 | 1 | 10 |
| | | |

2.270mm

Tubo di 2 m compreso
 Rapporto di compressione: 5:1
 Attacco entrata aria: 1/4"
 Attacco uscita olio: 1/2"
 Capacità olio a 6 bar
 (uscita libera) l/min.: 14
 Pressione di funzionamento: 6-8 bar.
 Massima pressione ammessa: 8 bar
 Diametro tubo aspiratore a parete: 42 mm
 Consumo d'aria: 250 l/min.
 Livello sonoro: 81 dB
 Temperatura erogazione olio: da -10 a + 50 °C
 Viscosità massima dell'olio: SAE 240
 Adatta per fusti da kg 180-220 a parete
 Peso kg 5,1
 Lunghezza del tubo metallico che va al fusto: mm 270
 Lunghezza del tubo flessibile che va al serbatoio: mm 2000mm



SISTEMA DI RIEMPIMENTO DELLA POMPA DI TRASMISSIONE

52797

219,00€

| | |
|--|----|
| | 5 |
| | 1 |
| | 24 |

Capacità: 7,5L
Tubo: 80cc cicli
Campo di viscosità:
SAE 140



RIMUOVE L'ARIA

13234 186,50€

SISTEMA DI RIEMPIMENTO DELLA POMPA DI TRASMISSIONE SENZA ACCESSORI REF. 52797

POMPA MANUALE RIMOZIONE GASOLIO

52789

16,00€

| | | |
|------|-----|-----|
| 0,15 | 100 | 600 |
| | | |

Lungo di tubo: 90cm ad ogni estremità.



POMPA INIETTORE DIESEL

52801

24,50€

| | | | |
|------|---|----|-------|
| 0,13 | 5 | 50 | 1.500 |
| | | | |



Durante la sostituzione della pompa di iniezione, filtri o altre parti, impedisce il ritorno del carburante nel serbatoio. Dopo l'assemblaggio delle parti sostituite permette di pompare il carburante fino alla linea di iniezione.

POMPA MANUALE PER ESTRAZIONE

52428

42,00€

| | | | |
|------|---|----|-----|
| 1,39 | 1 | 10 | 120 |
| | | | |



Per i fusti tra 50 e 200L.
400ml flusso impulse.
Capacità di pompaggio: 32L x min.
Adattatore 2" incluso.
Tubo di aspirazione di 101cm con 1 ingresso aria 1/4" e 1".
Non consentito per gli acidi forti, candeggianti, uscita di benzina.
Adatto a: oli, lubrificanti, gasolio, ADBLue
Consigliato per: acetone, solventi, antigelo, liquidi freni, erbicida.

POMPA MANUALE PER L'ESTRAZIONE DELL'OLIO

51253

39,00€

| | | |
|------|----|-----|
| 2,06 | 10 | 180 |
| | | |

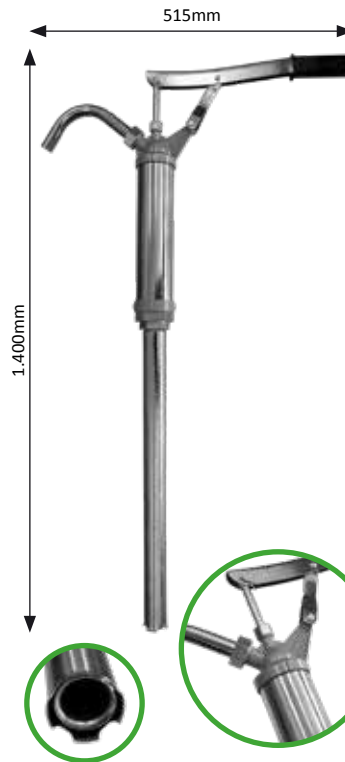

POMPA MANUALE IN PLASTICA

52329

33,00€

| | | |
|------|----|-----|
| 0,98 | 10 | 140 |
| | | |



ADBlue

Per i fusti di 25, 50, 200L
350ml pompato
Corpo e pistone in polipropilene
Manico in plastica ABS.
Applicazioni: oli Spirits, lubrificanti, benzina, diesel, cherosene, etc.
Linea di aspirazione:
Lunghezza minima: 320 millimetri
Lunghezza massima: 900 millimetri

POMPA MANUALE PER L'ESTRAZIONE DELL'OLIO

N

13982

2,50€

| | |
|------|-----|
| 0,05 | 100 |
| | |



DADO BIDONE PER REF. 50935 E 50918

10767

23,50€

| | |
|--|------|
| | 0,28 |
| | 90 |



10925

20,00€

| | |
|--|------|
| | 0,67 |
| | 90 |



AVVOLGITUBO DELL'OLIO ATTACCO DA 1/2"

| | | | |
|----------------|------|----|----|
| 50797 | 26,6 | 1 | 14 |
| 427,00€ | Kg | ff | ff |

Supporto/Avvolgitore per tubo dell'olio.
Lunghezza: 15 m.
Attacco da 1/2".



SIRINGA PLASTICA PER ESTRAZIONE OLIO

| | | | |
|---------------|------|----|-----|
| 52498 | 0,86 | 6 | 126 |
| 53,50€ | Kg | ff | ff |

1.500cc

Realizzato in polipropilene.
Corpo trasparente.
Ada o all'uso con olio di trasmissione e differenziale.
Resistente al liquido dei freni e anticongelante.



11867 10,00€

DUE O-RINGS
PER REF. 52498

INGRASSATORE PNEUMATICO

| | | | |
|---------------|----|----|----|
| 50751 | | | |
| 32,50€ | Kg | ff | ff |

| | | |
|-----|----|-----|
| 1,5 | 10 | 150 |
|-----|----|-----|

500cc

Pressione: 30Mpa



POMPA MANUALE PER ASPIRAZIONE

| | | | | |
|---------------|-----|-----|----|-----|
| 52628 | 0,3 | 5 | 50 | 450 |
| 29,50€ | Kg | sub | ff | ff |

200ml

Per liquido freni.
Connettore veloce sulla punta.



PISTOLA DI INGRASSAGGIO MANUALE CON TUBO FLEISSIBILE

| | | | | |
|---------------|-----|-----|----|-----|
| 50852 | 1,3 | 10 | 30 | 240 |
| 24,50€ | Kg | sub | ff | ff |

Ø 14mm esterno
Ø 5mm interno
Pressione: 20Mpa

500cc



PISTOLA ASPIRAZIONE OLIO

| | | | | |
|---------------|------|-----|----|-----|
| 51928 | 0,82 | 5 | 20 | 360 |
| 13,50€ | Kg | sub | ff | ff |

500cc



CROMATA



VASCA RACCOLTA LIQUIDI IN ACCIAIO

| | | | |
|---------------|------|----|----|
| 51356 | 2,39 | 5 | 40 |
| 42,00€ | Kg | ff | ff |

23 L

110mm

400mm

600mm



VASCA DI RACCOLTA PVC 15L

ANTIGELO

| | | | |
|---------------|------|---|----|
| 51876 | 0,96 | 4 | 32 |
| 21,00€ | Kg | | |



OLIO

| | | | |
|---------------|------|---|----|
| 51132 | 0,83 | 4 | 32 |
| 21,00€ | Kg | | |



Uscita di scarico laterale, Manici, PVC molto resistente, compatta.
Misure: 140mm Altezza / Diametro: 400mm

VASCA DI RACCOLTA OLIO 18L

ANTIGELO

| | | | |
|---------------|------|---|----|
| 53215 | 0,95 | 8 | 32 |
| 16,50€ | Kg | | |



OLIO

| | | | |
|---------------|------|---|----|
| 53144 | 0,99 | 8 | 64 |
| 15,50€ | Kg | | |



Uscita di scarico laterale, Manici, PVC molto resistente, compatta.

CARAFFA CON COLLO FLESSIBILE

| 2L | 5L |
|--------------|---------------|
| 52991 | 52992 |
| 7,50€ | 13,00€ |
| Kg 0,16 | Kg 0,36 |
| 20 | 8 |
| 240 | 96 |



IMBUTO PER TANICA DA 200L CON COPERCHIO E FILTRO

| | | | | | | |
|---------------|------|---|----|----|-------------|--------------------------------------|
| 53187 | 0,75 | 1 | 18 | 54 | 4,5L | Ø Interno: 245mm Ø Esterno: 255mm |
| 26,00€ | Kg | | | | | |



OLIATORE 250ml



| |
|--------------|
| 52243 |
| 7,00€ |
| Kg 0,17 |
| 5 |
| 60 |
| 720 |

OLIATORE 500ml



| | | | | |
|--------------|------|----|----|-----|
| 52242 | 0,28 | 10 | 60 | 480 |
| 9,50€ | Kg | | | |

SET DI 3 IMBUTI



| | | | |
|--------------|------|----|-----|
| 53188 | 0,15 | 24 | 288 |
| 4,50€ | Kg | | |

IMBUTO CON FILTRO



| |
|---------------|
| 52391 |
| 10,00€ |
| Kg 0,09 |
| 20 |
| 400 |

SET 2 IMBUTI MINI



| | | | |
|--------------|------|-----|-----|
| 52392 | 0,07 | 100 | 800 |
| 8,00€ | Kg | | |

IMBUTO CON IL TUBO FLESSIBILE



| | | | |
|--------------|------|----|-----|
| 53198 | 0,15 | 24 | 168 |
| 7,00€ | Kg | | |



UTENSILI IDRAULICI

| | |
|----------------------------------|-----|
| MARTINETTI IDRAULICO | 199 |
| CAVALLETTO | 201 |
| SOLLEVATORI A BOTTIGLIA. | 201 |
| PORTARUOTE. | 202 |
| PRESSE | 202 |
| PARANCO | 203 |
| SUPPORTI MOTORE. | 203 |
| RAMPA | 204 |
| PER I MOTOCICLI. | 204 |
| TRANSPALLET. | 206 |



MARTINETTO IDRAULICO 3T CON PEDALE

| | | | |
|----------------|----|---|----|
| 53112 | 40 | 1 | 18 |
| 191,50€ | Kg | | |



Min: 140mm
Max: 520mm

720 x 345 x 185mm

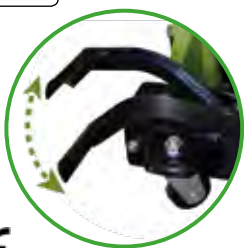

RAPIDA
ASCESA

CE



13853 102,50€

PISTONE IDRAULICO
PER CARRELLO
REF. 53112

N

13836 8,00€

PROTEZIONE
IN GOMMA PER
MARTINETTO A
CARRELLO RIF. 53112

MARTINETTO IDRAULICO CON PEDALLO DI SOLLEVAMENTO

| | | | |
|----------------|----|---|----|
| 53422 | 45 | 1 | 15 |
| 295,00€ | Kg | | |

Min: 100mm
Max: 533mm



778 x 372 x 165mm



LEVA DI
SOLLEVAMENTO

CIOTOLA CON
PROTEZIONE IN GOMMA

SCHIUMA

RUOTE DE
NYLON

CE



N

14071 9,50€

RUOTA GIREVOLE
PER REF. 53422

14072 17,50€

RUOTA FISSA
PER REF. 53422

14073 111,00€

PISTONE
PER REF. 53422

MARTINETTO IDRAULICO A CARRELLO

| | | | |
|----------------|------|---|----|
| 50818 | 37,5 | 1 | 18 |
| 172,00€ | Kg | | |

Min: 133mm
Max: 495mm



685 x 346 x 180mm

10768 123,50€

PISTONE
SOSTITUZIONE
PER REF. 50818

10639 12,00€

VITE D'ATTACCO
LATERALE
PER REF. 50818

10769 20,00€

VASCA DI SUPPORTO
PER REF. 50818

10770 7,00€

MOLLA CRICK
PER REF. 50818

CE

EN 1494:2001



| | | | |
|---------------|------|---|----|
| 50815 | 10,6 | 1 | 56 |
| 53,00€ | Kg | | |

Min: 130mm
Max: 355mm



490 x 205 x 140mm

CE



11939 53,00€

PISTONE IDRAULICO
PER CARRELLO REF. 50815

MARTINETTO IDRAULICO A CARRELLO SPECIALE PER AUTO CON PIANALE BASSO

| | | | |
|----------------|------|---|----|
| 53421 | 33,2 | 1 | 18 |
| 208,00€ | Kg | | |

Min: 75mm
Max: 505mm



740 x 360 x 150mm



N

14068 6,00€
RUOTA GIREVOLE
PER REF. 53421

14069 9,50€
RUOTA FISSA
PER REF. 53421

14070 99,50€
PISTONE
PER REF. 53421

MARTINETTO IDRAULICO A CARRELLO SPECIALE PER AUTO CON PIANALE BASSO

| | | | |
|---------------|-------|---|----|
| 50816 | 11,25 | 1 | 56 |
| 65,00€ | Kg | | |

Min: 85mm
Max: 330mm



560 x 212 x 145mm



11940 41,50€
PISTONE IDRAULICO
PER CARRELLO REF. 50816

MARTINETTO IDRAULICO CON MANICO ROTANTE 360°

| | | | |
|----------------|------|---|----|
| 51903 | 20,4 | 1 | 26 |
| 139,50€ | Kg | | |

Min: 120mm
Max: 420mm



651 x 705 x 175mm



N **11104 35,50€**
PISTONE SOSTITUZIONE
PER CARRELLO REF. 51903

MARTINETTO IDRAULICO A CARRELLO VALIGETTA DI PLASTICA

| | | | |
|---------------|------|---|----|
| 51895 | 11,5 | 1 | 42 |
| 64,00€ | Kg | | |



Min: 130mm
Max: 355mm

490 x 205 x 140mm



11940 41,50€
PISTONE IDRAULICO
PER CARRELLO REF. 51895

PRESA A FORBICE

| | | | |
|---------------|-----|---|-----|
| 53218 | 2,5 | 6 | 216 |
| 19,50€ | Kg | | |

Min: 85mm
Max: 360mm



Adatto a tutte le auto.



SET DI 2 CAVALLETTI

| | | | |
|---------------|------|---|----|
| 50832 | 7,31 | 1 | 70 |
| 36,50€ | Kg | | |

Min: 288mm
Max: 423mm



| | | | |
|---------------|------|---|----|
| 50833 | 10,3 | 1 | 31 |
| 86,00€ | Kg | | |

Min: 390mm
Max: 608mm



195mm

170mm



SUPPORTO DI SOLLEVAMENTO IN ALUMINIO

| | | | |
|---------------|-----|---|----|
| 53200 | 4,7 | 1 | 72 |
| 76,00€ | Kg | | |

2
PCS

Min: 245mm
Max: 385mm



SOLLEVATORE A BOTTIGLIA 2 - 15T

Min: 181mm Max: 345mm

| | | | |
|---------------|------|---|-----|
| 50819 | 2,43 | 1 | 288 |
| 20,00€ | Kg | | |



Min: 194mm Max: 372mm

| | | | |
|---------------|------|---|-----|
| 50820 | 3,22 | 6 | 300 |
| 24,50€ | Kg | | |



Min: 216mm Max: 413mm

| | | | |
|---------------|------|---|-----|
| 50821 | 4,22 | 5 | 200 |
| 34,50€ | Kg | | |



Min: 230mm Max: 460mm

| | | | |
|---------------|------|---|-----|
| 50822 | 5,79 | 4 | 160 |
| 46,00€ | Kg | | |



Min: 225mm Max: 365mm

| | | | |
|---------------|------|---|-----|
| 52304 | 7,59 | 2 | 144 |
| 63,50€ | Kg | | |



SOLLEVATORE A BOTTIGLIA CASSA PLASTICA

Min: 185mm Max: 340mm

| | | | |
|---------------|------|---|-----|
| 51905 | 2,76 | 6 | 144 |
| 23,00€ | Kg | | |



Min: 195mm Max: 385mm

| | | | |
|---------------|------|---|-----|
| 51906 | 3,58 | 4 | 144 |
| 29,50€ | Kg | | |



Min: 215mm Max: 450mm

| | | | |
|---------------|------|---|----|
| 51907 | 4,74 | 4 | 96 |
| 37,00€ | Kg | | |



SOLLEVATORE A BOTTIGLIA 20T

| | | | |
|---------------|----|---|----|
| 50823 | 10 | 2 | 96 |
| 74,00€ | Kg | | |



Min: 242mm Max: 452mm



SOLLEVATORE A BOTTIGLIA 20T PER AUTO BASSE

| | | | |
|---------------|------|---|----|
| 50824 | 8,35 | 2 | 96 |
| 71,00€ | Kg | | |



Min: 190mm Max: 335mm



SOLLEVATORE A BOTTIGLIA 30T

| | | | |
|----------------|-------|---|----|
| 50825 | 13,76 | 2 | 72 |
| 111,50€ | Kg | | |



Min: 285mm Max: 465mm



PORTARUOTE IDRAULICO

| | | | |
|----------------|----|---|---|
| 51901 | 75 | 1 | 6 |
| 605,00€ | Kg | | |



Lunghezza totale: 1.090mm
Larghezza totale: 1.040mm

Range di funzionamento:
50-100mm

CE

MARTINETTO IDRAULICO TELESCOPICO DA BUCA

| | | | |
|----------------|------|---|---|
| 50830 | 52,5 | 1 | 6 |
| 439,00€ | Kg | | |



Min: 850mm
Max: 1.740mm

Con impugnatura.
Rapido.
Doppio draulico.



12046 301,50€

PISTONE DI SOSTITUZIONE
PER REF. 50830

CE

BASE PER PRESSA

| | | | |
|----------------|-----|---|-----|
| 52999 | 7,6 | 2 | 120 |
| 158,50€ | Kg | | |

BASE GRANDE

200 X 250 X 40mm

BASE PICCOLA

200 X 70 X 40mm

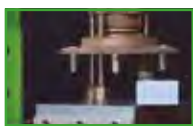
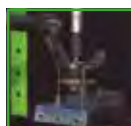

PRESSA DA 12T

| |
|----------------|
| 50812 |
| 319,00€ |

| | |
|----|----|
| Kg | 45 |
| | 1 |
| | 20 |

Larghezza utile:
470mm

130 x 56 x 56cm



CE

PRESSA DA 20T

| |
|----------------|
| 50813 |
| 439,00€ |

| | |
|----|------|
| Kg | 80,5 |
| | 1 |
| | 12 |

Range di
funzionamento:
0-988mm
Corsa: 190mm
Larghezza banco:
450mm

150 x 58 x 56cm



CE

PRESSA DA 30T

| |
|----------------|
| 50814 |
| 748,00€ |

| | |
|----|--------|
| Kg | 117,50 |
| | 1 |
| | 6 |

Range di
funzionamento:
310-1.150mm
Corsa: 130mm
Larghezza banco:
700mm

160 x 71 x 65cm



CE

PARANCO DA 1T PIEGHEVOLE

| | | | |
|----------------|----|---|----|
| 52985 | 74 | 1 | 16 |
| 389,50€ | | | |

Min: 70mm
Max: 2.160mm

Max. carico: 1,25T
Altezza di sollevamento:
70-2160mm
Estensione braccio: 81-105
Corsa del pistone: 460mm
Lunghezza Base: 1460mm
Misure: 1460x1460mm
Altezza Basamento: 970mm

1460 x 1460mm



13672 242,00€
PISTONI DI RICAMBIO
PER 52985

PARANCO DA 2T PIEGHEVOLE

| | | | |
|----------------|------|---|----|
| 50831 | 81,4 | 1 | 20 |
| 324,50€ | | | |

Min: 60mm
Max: 2.620mm

1.750 x 1.060 x 1.460mm

Altezza di sollevamento:
1'80m (2T) - 2,19m (1/2T)

Dimensioni piegato:
800 x 680 x 1.600mm
Capacità di sollevamento
- Posizione 1: 2T - 80mm
- Posizione 2: 1 1/2T - 255mm
- Posizione 3: 1T - 425mm
- Posizione 4: 1/2T - 610mm



12032 8,50€
RUOTE GIREVOLI
PER REF. 50831

11323 18,00€
SET DI VITI
PER GRUA
REF. 50831

14090 99,50€
PISTONE
SOSTITUZIONE
PER REF. 50831

PIEGA TUBI

| | | | |
|----------------|------|---|----|
| 50835 | 35,5 | 1 | 12 |
| 299,50€ | | | |

68 x 58,5 x 18,5mm

Piegare tubi fino a 2" (50mm).
Barre di piegatura regolabili.
Pressione: 0,75 - 0,75mpa.
Dimensioni acc:
1/2", 3/4", 1", 1/4", 1-1/2", 2".

PER USO ORIZZONTALE
E VERTICALE



SUPPORTO ALLINEATORE DEL MOTORE

| | | | |
|---------------|-----|---|----|
| 50631 | 6,3 | 1 | 98 |
| 66,00€ | | | |



Paranco non include.

SUPPORTO PER MOTORI

| | | | |
|----------------|-------|---|----|
| 50836 | 18,15 | 1 | 36 |
| 108,00€ | | | |

90 x 80 x 85cm



| | | | |
|----------------|------|---|----|
| 50838 | 43,9 | 1 | 12 |
| 214,50€ | | | |

Dimensioni piegato: 100 x 50 x 44cm.

110 x 90 x 90cm



SUPPORTO PER MOTORI

51452 34,50€
ATTACCO E MANOVELLA
PER REF. 50840

| | | | |
|----------------|-------|---|----|
| 50840 | 20,45 | 1 | 35 |
| 125,50€ | Kg | | |

500Kg

1750mm



CE

TRAVERSA DI SUPPORTO UNIVERSALE

| | | | |
|----------------|----|---|----|
| 52055 | 10 | 1 | 40 |
| 119,00€ | Kg | | |

500Kg
980 x 270mm

Adattabile a qualsiasi tipo di macchina e furgoncino.

Ottimo per il cambio della cinghia della distribuzione o delle cinghie ausiliari, e sostituzione o cambio d'inclinazione della cinghia di davanti.

Risparmio: con un solo utensile è possibile eseguire lavori che solitamente si possono realizzare con degli utensili specifici. Maneggevole.

Collocazione veloce, eseguibile da un solo operatore.

Collocazione e accesso per la parte inferiore.

Pezzo perpendicolare con angolo di giro ed agiustabile a qualsiasi altezza della sbarra longitudinale.

Traversa corta e ganci regolabile in altezza e ruotabili di 360 gradi. Base di appoggio in ABS per la massima aderenza.

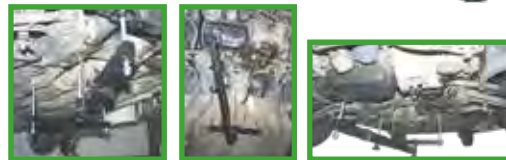

CE

RAMPA DI SOLLEVAMENTO 1T

| | | | |
|----------------|----|---|---|
| 52845 | 21 | 1 | 8 |
| 132,00€ | Kg | | |

1T

Utile per presentare veicoli di esposizione, così come i lavori di manutenzione sul fondo del veicolo.

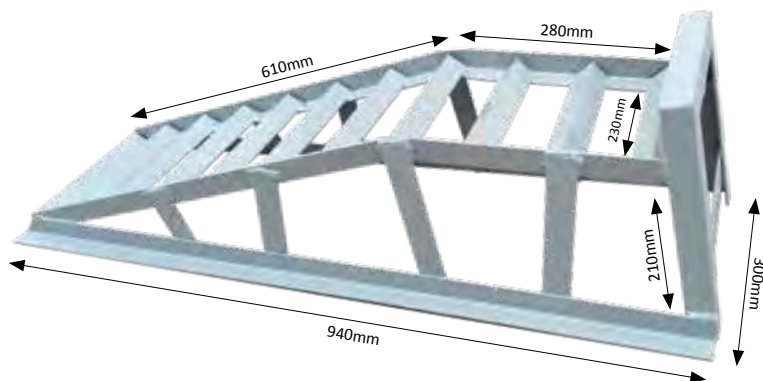

CE

SUPPORTO SOLLEVATORE PER MOTO

ANTERIORE

| | | | |
|---------------|----|---|----|
| 52514 | 4 | 1 | 26 |
| 70,50€ | Kg | | |

200Kg



CE

POSTERIORE

| | | | |
|---------------|----|---|----|
| 51751 | 5 | 4 | 12 |
| 65,00€ | Kg | | |

200Kg



CE

PROLUNGHE DI
APPOGGIO MOTO
PER SOLLEVATORE

PIANO (x2) 255mm
10671 17,00€



CIRCOLARE (x2)
11892 11,00€



TAVOLO IDRAULICO MOTOCICLETTE

| | | | |
|----------------|------|---|----|
| 52692 | 13,5 | 1 | 50 |
| 116,00€ | Kg | | |

Con bussole de 21mm.
Con Cricchetto de 3/8".

500Kg

Min: 95mm
Max: 400mm

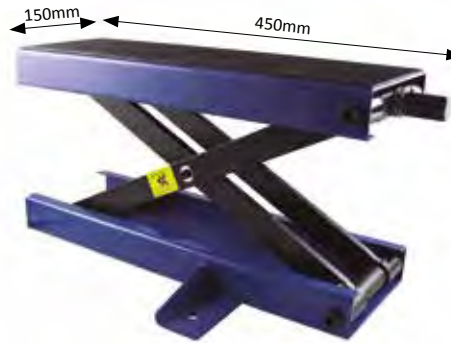

CE

SOLLEVATORE MOTOCICLETTE

| | | | |
|---------------|------|---|----|
| 51323 | 7,07 | 1 | 18 |
| 54,00€ | Kg | | |

140Kg

Min: 280mm
Max: 410mm

300 x 240mm



CE

TAVOLO IDRAULICO PER MOTOCICLETTE

| | | | |
|----------------|----|---|----|
| 51750 | 31 | 1 | 12 |
| 242,00€ | Kg | | |

135Kg

500 x 450 x 340mm

Min: 340mm
Max: 890mm



CE

TAVOLO IDRAULICO PER MOTOCICLETTE

| | | | |
|----------------|-----|---|---|
| 50911 | 135 | 1 | 5 |
| 814,00€ | Kg | | |

Min: 220mm
Max: 850mm

365Kg



2.200mm
Senza piattaforma: 2.000mm

500mm

TAVOLO IDRAULICO

| | | | |
|----------------|----|---|---|
| 50630 | 62 | 1 | 5 |
| 407,00€ | Kg | | |

Min: 290mm
Max: 780mm

400Kg

840 x 480mm



11087 18,00€
SOPORTE AFFERRARE
FISSO

11088 32,00€
SOPORTE AFFERRARE
MOVILE

CE

10993 105,50€
PISTONE DI SOSTITUZIONE
PER REF. 50630

11950 20,00€
ASSE DI SOSTITUZIONE
PER REF. 50630

CE

TAVOLO IDRAULICO

| | | | | | |
|----------------|-----|---|---|----------------------------|--------------|
| 53246 | 104 | 1 | 4 | Min: 370mm Max: 1.350mm | 360Kg |
| 858,00€ | Kg | | | | |



MARTINETTO ATV

| | | | | |
|----------------|------|---|----|--------------------------|
| 53423 | 28,5 | 1 | 24 | Min: 118mm Max: 368mm |
| 171,00€ | Kg | | | |

680 Kg

790 x 370 x 330mm



TRASPORTATORE IDRAULICO 680Kg

| | | | |
|----------------|------|---|----|
| 50839 | 20,5 | 1 | 10 |
| 214,50€ | Kg | | |

Apertura totale: 254 mm.
Misura interna chiuso: 12".
Misura interna aperta: 47 cm.
Lunghezza in plastica nera delle gambe: 30 cm.
Lunghezza con ruote: 60 cm.



CE

SOLLEVATORE TRANSPALLET

| | | | | | |
|----------------|-------|---|----|-------------|--------------|
| 53386 | 60,85 | 2 | 24 | 2,5T | 1150 x 525mm |
| 638,00€ | Kg | | | | |



CARRELLO TRASPORTATORE SPECIALE LAMIERA

| | | | |
|----------------|------|---|----|
| 50923 | 32,9 | 1 | 15 |
| 247,50€ | Kg | | |

340Kg

48 x 80 x 130cm

Separazione da 0 a 110cm.

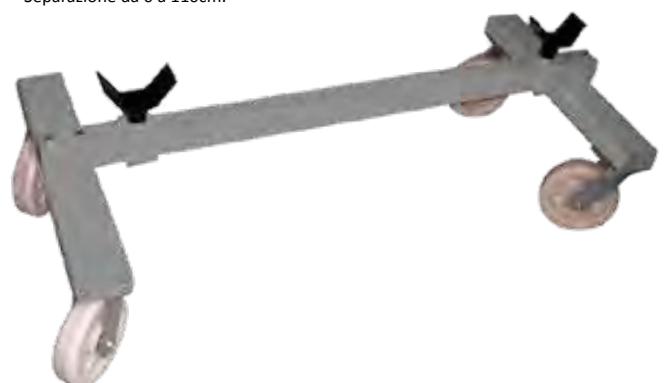

CE

12022 37,50€
RUOTE PER REF. 50923



UTENSILI ELETTRICI

| | |
|---|-----|
| CAVI DI AVVIAMENTO | 208 |
| CARICA BATTERIA. | 208 |
| TESTER PER BATTERIE DIGITALE | 209 |
| PINZA AMPEROMETRICA | 209 |
| MULTIMETRO DIGITALE | 210 |
| TERMOMETRO | 210 |
| TESTER CIRCUITO AUTOMOTIVE. | 211 |
| RILEVATORE DI FUGHE DI GAS | 212 |
| SALDATORE | 212 |
| PISTOLA DA ARIA CALDA | 212 |
| AVVITATRICE PER DADI ELETTRICO | 213 |
| TRAPANO | 213 |
| ASPIRATORE. | 213 |
| PULITRICE DI PEZZI. | 214 |
| MOLA ELETTRICA. | 215 |
| TORNIO ELETTRICO. | 215 |
| AVVOLGITORE DI CAVO ELETTRICO. | 215 |



CAVI DI AVVIAMENTO

PINZA IN OTTONE MASSICCIO

| REF. | Ø CAVO + RIVESTIMENTO | LUNGO | Ah | SEZIONE | Kg | ft | € |
|-------|-----------------------|-------|-----|---------|------|----|---------|
| 51238 | 17mm | 5m | 700 | 70mm² | 5,02 | 2 | 97,00€ |
| 51239 | 15mm | 7m | 700 | 70mm² | 5,98 | 2 | 130,00€ |

PINZA IN OTTONE

| REF. | Ø CAVO + RIVESTIMENTO | LUNGO | Ah | SEZIONE | Kg | ft | € |
|-------|-----------------------|-------|-----|---------|------|----|--------|
| 52069 | 11mm | 2,5m | 250 | 25mm² | 1,62 | 10 | 18,00€ |
| 52070 | 12mm | 3m | 350 | 35mm² | 2,1 | 5 | 26,50€ |
| 52071 | 13mm | 3m | 500 | 50mm² | 2,34 | 5 | 32,00€ |

PINZA IN OTTONE MASSICCIO CON PROTEZIONE DI SOVRACCARICO

| REF. | Ø CAVO + RIVESTIMENTO | LUNGO | Ah | SEZIONE | Kg | ft | € |
|-------|-----------------------|-------|-----|---------|------|----|--------|
| 51363 | 12mm | 3m | 350 | 35mm² | 2,63 | 5 | 75,00€ |
| 51365 | 12mm | 3m | 500 | 50mm² | 3,12 | 5 | 86,00€ |



CE

AVVIATORE DI EMERGENZA PER AUTO SENZA BATTERIA

| | | |
|---------|------|----|
| 53387 | 1,45 | 10 |
| 237,00€ | Kg | ft |



12V + uscita USB

Dotato di **condensatori** in grado di immagazzinare una carica elettrica sufficiente a consentire l'avvio di un veicolo senza batteria.

L'avviamento può essere caricato da una **batteria scarica**. Alimentazione in uscita: 12V/USB.



CORRENTE DI AVVIAMENTO

450A CC12V



x5 CONDENSATORI

2.7V 500F



TEMPERATURA DI LAVORO

-20°C a 60°C



TEMPO DI AVVIO

70 secondi



CARICA BATTERIA 12 - 24V

12V 50-140Ah

Corrente di carico: 7A
Campo di applicazione: 12V / 50-140Ah

| | | | |
|--------|------|----|-----|
| 52290 | 1,14 | 10 | 320 |
| 79,50€ | Kg | ft | ft |

12V 134-400Ah

Corrente di carico: 20A
Campo di applicazione: 12V / 134-400Ah

| | | | | |
|---------|------|----|----|-----|
| 52291 | 1,36 | 5 | 10 | 320 |
| 147,50€ | Kg | ft | ft | ft |

24V 70-200Ah

Corrente di carico: 20A
Campo di applicazione: 24V / 70-200Ah

| | | | |
|---------|------|----|-----|
| 52292 | 1,36 | 10 | 320 |
| 166,00€ | Kg | ft | ft |

Durante la ricarica, automaticamente evita il sovraccarico. Con la funzione AUTO-STOP la ricarica termina quando la batteria è completamente carica.

La ricarica della batteria avviene in 7 fasi che impediscono danni e ne permettono la carica ottimale. PER BATTERIE ACIDE, AGM, GEL



CE

INVERTITORE DI POTENZA 300W 12-220V

52954

61,50€

Kg 0,6

ft 6

ft 24

ft 240



300W

40A

DC 12V

AC 220V



USB

UNIVERSALE

CE



TESTER PER BATTERIE DIGITALE

| | | | | |
|---------------|-----|---|----|-----|
| 51816 | 0,3 | 6 | 48 | 576 |
| 54,00€ | | | | |

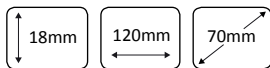

150Ah
Per batterie da 12 V.
Misurazione in SAE CCA), EN, IEC, DIN, CA
Range: 200 ~ 1200 CAA (SAE)
Misuratore di Volt: 7 V ~ 15 V
Display 4+3 Leds (verde, rosso, giallo).



TESTER PER BATTERIE

| | | | |
|---------------|------|----|-----|
| 51235 | 1,35 | 10 | 150 |
| 51,00€ | | | |

Per batterie da 6 V e 12 V.
Carica di sino a 100 Ah.
Test dello stato di carica.
Test di consumo all'avviamento.
Test di voltaggio di carica.
Test delle condizioni della batteria.



TESTER DIGITALE PER BATTERIE E ALTERNATORI CON STAMPANTE

| | | | |
|----------------|------|---|----|
| 52233 | 2,32 | 6 | 72 |
| 383,00€ | | | |

Per batterie da 6V e 12V
Sistema di carico e avviamento da 12V e 24V
Range: 40 - 2000 CCA (SAE)
Misuratore di volt: 1.5V - 30V
Set di cavi da 180cm

Include:
Batterie 6x1.5AA
1 rotolo di carta termica 57mm x 30m

| | |
|--------------|--------------|
| 51842 | 8,00€ |
|--------------|--------------|

CARTA TERMICA PER STAMPANTE 57mmx60m

| | | |
|-----|---|-----|
| 0,1 | 6 | 120 |
| | | |



CON ESTAMPANTI

AGM, GEL, VRLA, SLI



IDROMETRO PER BATTERIA

| | | | |
|--------------|------|----|-----|
| 53209 | 0,15 | 10 | 100 |
| 6,00€ | | | |

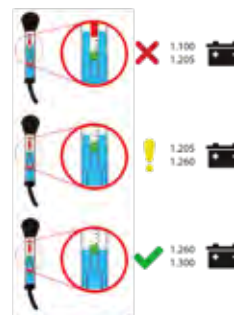

ALIMENTATORE DI BACKUP SERVIZI VIA OBD II PER SOSTITUZIONE DELLE BATTERIE

| | | | | |
|---------------|------|---|----|-----|
| 52884 | 0,25 | 5 | 20 | 400 |
| 56,00€ | | | | |



Utile per mantenere la corrente al sistema elettrico del veicolo durante la sostituzione della batteria. Connessione via cavo OBDII o presa accendisigari.



235mm ± 20mm



2.070mm ± 20mm



MULTIMETRO CON PINZA AMPEROMETRICA

| | | | | |
|---------------|------|---|----|-------|
| 52382 | 0,23 | 5 | 50 | 1.600 |
| 20,00€ | | | | |

FUNZIONI:
Test filo vivo

| | | | | |
|---------------|------|---|----|-------|
| 52952 | 0,26 | 5 | 50 | 1.500 |
| 71,50€ | | | | |

FUNZIONI:
Test filo vivo
Prova diodi
Prova continuità

Funzione ADP
Funzione rilevazione di fase
Pulsante ZERO



| | 52382 | 52952 |
|-----|-----------------|-----------|
| DCB | 600V | 20V, 600V |
| ACB | 600V | 600V |
| DCA | | 200A |
| ACA | 20A, 200A, 600A | 200A |
| OHM | 2KΩ, 200KΩ, 2MΩ | 2000Ω |

Massimo valore sul display: 1999, indicazione di polarità automatica.
Temperatura funzionamento: 0°C a 40°C, umidità <80%RH.
Temperatura di stoccaggio: -10°C a 40°C, umidità <85%RH.

Alimentazione: 2 batterie tipo AAA.
Indicatore di batteria scariche.
Elettricità statica: circa 4mA.
Metodo di misura: doppio.
Interruttore integrato AC/DC.
Dimensioni: 167x55x22.



52382

52952

MULTIMETRO DIGITALE

| | | | | |
|---------------|------|----|----|-----|
| 50942 | 0,33 | 10 | 60 | 480 |
| 26,50€ | | | | |

Caratteri 3" 1/2.
Misurazione: 2000.
Dati istantanei.
Spegnimento automatico.
Indicatore livello di carica della batteria.

Batteria da 9 V.
Sonda della temperatura.
Temperatura: da -40 °C a 1000 °C.



| | |
|---|---------------------------------|
| V AC 200mV, 2V, 20V, 200V, 1000V | A AC 20mA, 200mA, 20A |
| V DC 200mV, 2V, 20V, 200V, 750V | A DC 20mA, 200mA, 20A |
| Ω 200Ω, 2KΩ, 20KΩ, 200KΩ, 2MΩ, 20MΩ, 2000MΩ | |
| F 2nF, 20nF, 200nF, 2μF, 20μF, 200μF | |

PROTEZIONE
LATERALE



KIT CAVI E ACCESSORI PER REF. 50942

| | | | | |
|----------------|------|---|---|----|
| 52439 | 3,26 | 1 | 5 | 40 |
| 207,00€ | | | | |

2 misurazione della resistenza variabile.
Controllare due luci LED.
2 SRS sostituzione e dispositivi di test.
2 pinze cocodrillo.
2 prese attacco rapido.
4 sensori.
24 connettori circolari.
48 connettori piatti.



KIT DI ACCESSORI PER MULTIMETRO

| | | | | |
|---------------|------|---|----|-----|
| 52231 | 0,41 | 5 | 40 | 300 |
| 44,00€ | | | | |

Questo kit è adatto per quasi tutti di multimetri.

Include:
2 sonde.
2 pinze piccole + 2 pinze lunghe.
Cavi d'estensione.



TERMOMETRO LASER -50° A 330°C

| | | | | |
|---------------|---|--|--|--|
| 52162 | Gamma di misurazione: Di -50°C fino a 330°C (58°F a 626°F). | | | |
| 44,00€ | Precisione: ±2°C/±2%. | | | |
| | 0,17 | | | |
| | 6 | | | |
| | 72 | | | |
| | 576 | | | |

Decimali: 1.
Opzione di retro illuminazione.
Puntatore laser per una misurazione precisa dall'oggetto.
Misurazione in °C/°F.
Emissività: 0,95 (Predeterminata).
Tempo di risposta: 500ms.
Possibilità di bloccaggio di misurazione.
Indicatore di batteria scarica.



TERMOMETRO LASER -50° A 1.000°C

| | | | | |
|----------------|---|--|--|--|
| 52450 | Gamma di misurazione: di -50°C ~1000°C / -58°F a 1.832°F. | | | |
| 138,50€ | Precisione +/- 1,5°C. | | | |
| | 0,72 | | | |
| | 5 | | | |
| | 20 | | | |
| | 200 | | | |

Opzione di retro illuminazione.
Puntatore laser per una misurazione precisa dall'oggetto.
Misurazione in C°/°F.
Emissività: 0,95 (Predeterminata).
Tempo di risposta: 500ms.
Possibilità di bloccaggio di misurazione.
Batteria 9V DC.
Indicatore di batteria scarica.



TERMOMETRO A CONTATTO DIGITALE

| | | | | |
|--------------|------|----|-----|--|
| 53503 | 0,05 | 20 | 100 | |
| 9,00€ | | | | |

| | | | |
|------|----------------|-----------------|--|
| 1.5V | ± 1°C (0.2°F) | -50°C ~ +330 °C | |
| | (-20°C - 80°C) | -58°F ~ +572 °F | |



TESTER CIRCUITO AUTOMOTIVE

Adatta per verificare la polarità.

| | | | | |
|--------------|------|----|-----|-------|
| 53028 | 0,07 | 10 | 120 | 1.800 |
| 4,00€ | | | | |

6 -12 -24V



1,8 x 190mm

| | | | | |
|--------------|------|----|-----|-------|
| 53029 | 0,08 | 12 | 240 | 2.400 |
| 4,50€ | | | | |

6 -12 -24V



2 x 115mm

| | | | | |
|---------------|------|---|----|-----|
| 53030 | 0,17 | 6 | 60 | 720 |
| 10,00€ | | | | |

6 -12 -24V

LED



3 x 142mm

RILEVATORE DI FUGHE DI GAS



| | | | | | | |
|----------------|----|----|----|-----|-------|--------|
| 53484 | 5 | 4 | 28 | 12V | 6 | 15 PSI |
| 762,50€ | Kg | ft | ft | | L/min | |



GUARDA IL VIDEO TUTORIAL

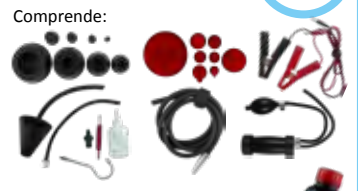

Comprende:

| | | |
|----------------------------|--------------|----------------|
| OLIO 500ML PER REF. 53484 | 14081 | 12,00€ |
| TUBO DI RICAMBIO PER 53484 | 14109 | 32,00€ |
| POMPA MANUALE PER 53484 | 14110 | 121,00€ |

TESTER DEL LIQUIDO DEI FRENI

| | | | | |
|---------------|------|----|-----|-------|
| 51839 | 0,05 | 10 | 100 | 2.400 |
| 31,00€ | Kg | ft | ft | ft |



Funziona a pile 1 x AAA LR03.
Con 4 livelli di qualità misurabili dallo 0% al 4%.



ENDOSCOPIO INDUSTRIALE CAVO 1m

| | | | |
|----------------|------|----|----|
| 52436 | 2,41 | 5 | 40 |
| 913,00€ | Kg | ft | ft |

Cibo: DC5.
Controllo 3,5TFT 320x240px.
Interfaccia: MINI USB 1.1/AV.
Batteria ricaricabile Li-Polymer 3.7V.
Adaptatore: 100-240V.
Uscita AC 5VDC.
Video NTSC&PAL.
Conservazione: CARD SD (fino a 32Gb).
Compressione: JPG.
Recording: MPEG4 (640x480).
Temperatura di funzionamento: -20°C - 60°C.
Temperatura di stoccaggio: 0°C - 40°C.
Diam. cable: 5mm.
Funzioni: Uscita video, 6 lingue, auto-off, foto, video, data/ora.



| | | | | | |
|--------------|----------------|--------------|----------------|------------------------------|---------------|
| 11329 | 399,50€ | 11219 | 606,50€ | 11992 | 66,00€ |
| CAVO 1m | | CAVO 3m | | RICAMBI PUNTA PER ENDOSCOPIO | |

SALDATORE DA 40W

| | | | | |
|---------------|------|----|-----|-----|
| 52383 | 0,22 | 5 | 100 | 700 |
| 18,00€ | Kg | ft | ft | ft |

Tensione: 220-240V.
Temperatura: 420°C +/- 10%.
Lunghezza: 250mm.
Cavo: 1,5m.

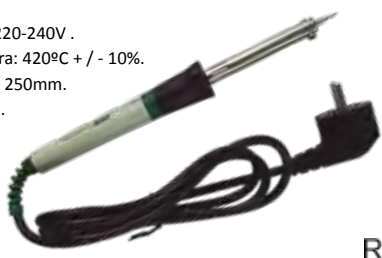

PISTOLA SALDATRICE A STAGNO 100W

| | | | | |
|---------------|------|----|----|-----|
| 53111 | 0,28 | 5 | 25 | 500 |
| 13,50€ | Kg | ft | ft | ft |

Voltaggio: 220-240V.
Temperatura: 420°C +/- 10%.
Lunghezza: 250mm.
Cavo: 1,5m.



PISTOLA PER ADESIVO TERMOFUSIBILE

| | | | | |
|---------------|------|----|----|-----|
| 51831 | 0,35 | 12 | 36 | 252 |
| 15,50€ | Kg | ft | ft | ft |

| | | | |
|-----------------------|--------------|-----|-------|
| 51859 | 4,50€ | x11 | |
| ADESIVO TERMOFUSIBILE | | | |
| 0,12 | 11 | 40 | 1.520 |
| Kg | ft | ft | ft |

Ø 8mm.
Incolla rapidamente ogni tipo di materiale flessibile.
Tempo di asciugatura: 20".



Voltaggio: 100 ~ 230 V
Temperatura: 190 ~ 230 °C
Consumo: 60 ~ 150 W
Diametro beccuccio: 2,0 ~ 2,3 mm
Range: da 8 a 16 g di prodotto/minuto

PISTOLA DA ARIA CALDA 2000W

| | | | |
|---------------|----|----|-----|
| 53145 | 1 | 5 | 165 |
| 32,50€ | Kg | ft | ft |

220V-240V 50Hz-60HZ 2000W
Temperatura di uscita: 50-600°C.
Flusso d'aria: 220-480L / min.
2 Opzioni di temperatura: 300 i 600.



| | | | |
|---------------|-----|----|-----|
| 53162 | 0,9 | 5 | 165 |
| 52,50€ | Kg | ft | ft |

220V-240V 50Hz-60HZ 2000W
Temperatura di uscita: 100-600°C.
Flusso d'aria: 280-480L / min.



DIGITALE

AVVITATRICE PER DADI ELETTRICO 1/2"

520Nm

N

| | | | |
|----------------|------|----|----|
| 53491 | 6,15 | 4 | 32 |
| 603,00€ | Kg | ff | ff |



Numero di percussioni: 3200/minuto

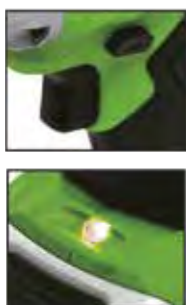

BATTERIA 18V 4.0AH

| |
|----------------|
| 14092 |
| 147,50€ |
| 0,64 |
| 10 |
| Kg |
| ff |

TRAPANO VERTICALE CON VARIATORE DI VELOCITÀ A INGRANAGGI

8"- 220V

| | | | |
|----------------|------|----|----|
| 52192 | 15,5 | 1 | 21 |
| 174,00€ | Kg | ff | ff |



20"- 220V

| | | | |
|------------------|-----|----|----|
| 52194 | 135 | 1 | 3 |
| 1.089,00€ | Kg | ff | ff |



10"- 220V

| | | | |
|----------------|-------|----|----|
| 52193 | 28,25 | 1 | 12 |
| 341,00€ | Kg | ff | ff |



CE

| | 52192 | 52193 | 52194 |
|----------------------------------|---------------|-------------|------------------|
| Ø di colonna (mm) | 48 | 59,5 | 92 |
| Cerniera e pignone | x | ✓ | ✓ |
| Misura della base (mm) | 280 x 180 | 350 x 215 | 580 x 450 |
| Misura dal tavolo di lavoro (mm) | 165 x 160 | 198 x 196 | 475 x 425 |
| Motore | 300 W | 400 W | 1000 Br / 1500 W |
| Altezza (mm) | 580 | 720 | 1710 |
| Peso netto/lordo | 17/19 | 30/32 | 139/145 |
| Misura della cassa (mm) | 470x240x350 | 550x370x254 | 1450x653x333 |
| Capacità di perforazione (mm) | 13 | 16 | 32 |
| Capacità del portapunte | 13 | 16 | 20 |
| Capacità del collo | 40 | 55 | 75/85 |
| Percors | 8" | 10" | 20" |
| Cono del mandrino | B16/JT33 | MT2 | MT3/MT4 |
| Velocità in rpm (50hz) | 5 (500-2.500) | 5/12 | 12 (120-3.480) |
| Velocità in rpm (60hz) | 5 (620-3.100) | 5/12 | 12 (150-3.850) |
| Percorso del mandrino (mm) | 50 | 60 | 120 |

ASPIRATORE

SECCO DA 30L

| | | | |
|----------------|------|----|----|
| 51837 | 8,25 | 1 | 9 |
| 193,00€ | Kg | ff | ff |



INCLUDE



PEZZI DI RICAMBIO PER REF. 51837

| REF. | DESCRIZIONE | € |
|-------|--------------------------|--------|
| 10720 | Manguera plástico 1,5m | 16,50€ |
| 11095 | Manguera plástico 3m | 21,50€ |
| 11097 | Manguera plástico 6m | 37,00€ |
| 10721 | Tubo de metal extensible | 21,00€ |
| 10761 | Filtro | 18,00€ |

SECCO + UMIDO DA 80L

| | | | |
|----------------|----|----|----|
| 51838 | 28 | 1 | 2 |
| 658,00€ | Kg | ff | ff |



INCLUDE



PEZZI DI RICAMBIO PER REF. 51838

| REF. | DESCRIZIONE | € |
|-------|------------------------|--------|
| 10722 | Manguera plástico 1,5m | 16,50€ |
| 11096 | Manguera plástico 3m | 25,00€ |
| 11098 | Manguera plástico 6m | 45,00€ |
| 10723 | Codo superior | 16,00€ |
| 10724 | Codo inferior | 16,00€ |
| 10762 | Filtro | 18,50€ |

| | 51837 | 51838 |
|------------------|------------|------------|
| Capacità | 30 | 80 |
| Potenza (Motore) | 1 x 1.000W | 3 x 1.000W |
| Voltaggio | 220V | 220V |
| Frequenza | 50Hz | 50Hz |
| Evacuazione | > 17Kpa | > 20Kpa |
| Diam. Tubo | 32mm | 48mm |
| Lunghezza Tubo | 1,5m | 1,5m |
| Lunghezza Cavo | 4,8m | 4,8m |
| Tenuta | IPx4 | IPx4 |

CE

PULITRICE DI PEZZI 100L.

| | | | |
|----------------|------|---|---|
| 50632 | 24,3 | 1 | 6 |
| 231,00€ | Kg | | |

MISURE INTERNE DELLA VASCA

| | | |
|-------|-------|-------|
| 260mm | 725mm | 490mm |
|-------|-------|-------|

MISURE TOTALI

| | | |
|-------|-------|-------|
| 890mm | 780mm | 540mm |
|-------|-------|-------|

Flusso: 25L

Funziona con olio motore pulito solubile in acqua.



11100 18,00€

PUNTA A PENNELLO



11101 75,00€

POMPA RICAMBIO



11102 7,50€

FILTRO VASCA DI PULIZIA PER 50632



PULITRICE DI PEZZI 150L

| | |
|----------------|--|
| 52980 | |
| 405,00€ | |

| | |
|--|----|
| | 45 |
| | 1 |
| | 4 |

MISURE INTERNE DELLA VASCA

| | | |
|-------|--------|-------|
| 490mm | 1060mm | 270mm |
|-------|--------|-------|

MISURE TOTALI

| | | |
|-------|--------|-------|
| 890mm | 1090mm | 520mm |
|-------|--------|-------|



PULITRICE PORTATILE

| | | | |
|----------------|-----|---|---|
| 53220 | 7,9 | 1 | 8 |
| 285,00€ | Kg | | |

Collegamento a 220V.
Capacità di pompaggio: 1.000 L / h.
Usare con solvente a base acquosa.

FORMATO PORTATILE.

Permette la chiusura a tenuta stagna per evitare perdite durante il trasporto.

- Interruttore di accensione laterale
- Filtro di pulizia liquido incluso
- Supporto flessibile per utensili e tubo incluso
- scomparto di stoccaggio
- Separazione delle aree di lavoro, area di pulizia e zona di asciugamento, consente di lavorare con più pezzi alla volta.
- Tubo di 1,10 m.



MACCHINA PER MARCARE LO PNEUMATICO POTENZA MASSIMA 350W

| | | | |
|----------------|------|---|----|
| 52643 | 7,96 | 1 | 44 |
| 539,00€ | Kg | | |



| | | | | | |
|--|--------------|-----------------|--|--------------|-----------------|
| | 11974 | 1,50€/u. | | 11979 | 1,50€/u. |
| | 11975 | 1,50€/u. | | 11980 | 1,50€/u. |
| | 11976 | 1,50€/u. | | 11981 | 1,50€/u. |
| | 11977 | 1,50€/u. | | 11982 | 1,50€/u. |
| | 11978 | 1,50€/u. | | 11983 | 1,50€/u. |

RICAMBIO

1,50€/u.

| REF. | 11974 | 11975 | 11976 | 11977 | 11978 |
|---------------------|-----------|-----------|-----------|-----------|-----------|
| TIPO DI LAMA | R1 | R2 | R3 | R4 | R5 |
| LAME ARROTONDATA | mm | mm | mm | mm | mm |
| | A | B | C | D | |
| | 3 | 7 | 5 | 21 | |
| | 5 | 7 | 8 | 21 | |
| | 6 | 10 | 15 | 23 | |
| | 8 | 12 | 16 | 25 | |
| | 10 | 12 | 18 | 24 | |

| REF. | 11979 | 11980 | 11981 | 11982 | 11983 |
|---------------------|-----------|-----------|-----------|-----------|-----------|
| TIPO DI LAMA | W1 | W2 | W3 | W4 | W5 |
| LAME QUADRATA | mm | mm | mm | mm | mm |
| | A | B | C | D | |
| | 3 | 7 | 5 | 21 | |
| | 5 | 7 | 8 | 21 | |
| | 6 | 10 | 15 | 23 | |
| | 8 | 12 | 16 | 25 | |
| | 10 | 12 | 18 | 24 | |

MOLA ELETTRICA 150mm

52195

142,00€

| | |
|--|------|
| | 7,08 |
| | 1 |
| | 48 |

Potenza nominale di entrata: 250W

Tensione nominale: 230V / 50Hz

Velocità senza carico: 2.950Rpm

Ø della ruota: 150 x 20 x 12.7mm

Peso netto: 8,5Kg



MOLA ELETTRICA 150-200mm

52196

165,00€

| | |
|--|-------|
| | 10,56 |
| | 1 |
| | 18 |

Potenza nominale di entrata: 250W

Tensione nominale: 230V / 50Hz

Velocità senza carico: 2.950Rpm

Ø della ruota: 150 x 20 x 12.7mm / 200 x 40 x 20mm

Peso netto: 8,5Kg



TORNIO ELETTRICO

51118

3.278,00€

| | | |
|-----|---|---|
| 197 | 1 | 2 |
| | | |



| | |
|--|---------------------|
| Altezza del centro | 125mm |
| Diametro di oscillazione massima, al banco | 250mm |
| Massimo diametro del pezzo di lavoro sul carrello | 130mm |
| Massima distanza del pezzo di lavoro tra gli assi (centramento) | 450mm |
| Massima lunghezza longitudinale. | 420mm |
| Diametro del perno: | 27mm |
| Perno a foro conico (cono Morse) | CM4 |
| Numero di velocità di rotazione della testa | 6 |
| Regime di rotazione dell'asse (da avanti in dietro) | 115 - 1620 t/min |
| Numero di reti (passo metrica normale) | 20n |
| Tipo di filetto (filetto metrico normale) | 0.2 - 3,5mm |
| Numero di reti (passo in pollici - Whitworth) | 20n |
| Gamma di fili (in pollici) | 8-56 t.p.i |
| Numero di reti non standard | 10 |
| Gamma di fili (standard) / numero di avanzamenti longitudinali e assiali | De 0.2 a 1,25 |
| Gamma di barre di carrello | 0.05. 0.1 / 2mm |
| Distanza tra l'asse del perno e la superficie inferiore della testa quadrata | 15 |
| Angolo massimo di rotazione anteriore del carrello (backstage) | + - 45° |
| Esecuzione di ogni parte della filettatura del carrello trasversale | 0,04mm |
| Esecuzione di ogni parte della filettatura prima | 0,04mm |
| Massima escursione. In avanti | 70mm |
| Massima escursione trasversale del carrello | 115mm |
| Slitta foro conico (perni mobili) cono Morse | CM2 |
| Corsa massima (perni mobili) | 70mm |
| Motore | 0.37 kW, 220V, 50Hz |
| Misure (cm - altezza x larghezza x lunghezza) | 1.130 x 600 x 1.400 |

ACCESSORI INCLUSO



| REF. | CARATTERISTICHE | € |
|-------|-----------------------------|---------|
| 11075 | 2 Punti guida | 64,00€ |
| 11076 | 3 punti guida | 102,00€ |
| 11077 | Portamandrino | 86,00€ |
| 11078 | Chuck + manovella | 344,50€ |
| 13001 | Gioco di punte | 113,50€ |
| 11080 | Plate 5 hole universal | 108,00€ |
| 11082 | Adattatore plate per tornio | 10,00€ |

| REF. | CARATTERISTICHE | € |
|-------|---|---------|
| 11084 | Ricambio visore valvola | 73,50€ |
| 11085 | Adattatore 3 claws per tornio | 218,00€ |
| 11079 | Plate 5 hole universal per tornio | 24,50€ |
| 11081 | Ricambio ruota mano per tornio ref. 51118 | 21,50€ |
| 11083 | Tavolo per tornio | 429,00€ |
| 11086 | Ricambio plastico protettore per tornio | 20,00€ |
| 11930 | Ricambio motor per tornio | 321,50€ |

COMPRESSORE D'ARIA

51602

242,00€

| | |
|--|------|
| | 23,9 |
| | 1 |
| | 6 |

25L

51603

308,00€

| | |
|--|----|
| | 28 |
| | 1 |
| | 4 |

50L



| | 51602 | 51603 |
|------------------------|----------------|----------------|
| Capacità (L) | 25 | 50 |
| Potenza | 1.5 kW/2HP | 1.5 Kw/2,5HP |
| Voltaggio | 230 V | 230 V |
| Frequenza | 50 Hz | 50 Hz |
| Motore postes | 2P | 2P |
| Velocità | 1.500 r/min | 2.950 r/min |
| Amperaggio | 7.5A | 7.5A |
| Erogazione | 7.3 CFM | 8.4 CFM |
| Pressione di mandata | 115PSI/0.8Mpa | 115PSI/0.8Mpa |
| Pressione di reset | 70PSI / 0.5Mpa | 70PSI / 0.5Mpa |
| Capacità del serbatoio | 1/4" | 1/4" |
| Peso netto | 41Kg | 45Kg |
| Aria aspirata l/min | 234 l/min | 240 l/min |
| Aria aspirata m3/h | 14,08 | 14,30 |
| Dimensioni | 760x270x580 | 810x370x670 |

AVVOLGITORE DI CAVO ELETTRICO

N

| | | | |
|----------------|-----|----|-----|
| 53526 | 4,7 | 4 | 120 |
| 108,00€ | Kg | ff | |



CON RIPARTITORE

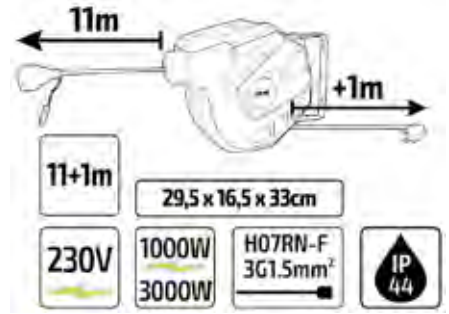

AVVOLGITORE DI CAVO ELETTRICO

| | | | |
|----------------|-----|----|----|
| 52429 | 5,1 | 2 | 64 |
| 103,50€ | Kg | ff | |

Lunghezza: 12 m.
Cavo: H07RN-F 3G1.5mm.
Tensione di funzionamento:
230V - 50Hz.
Massima potenza:
3.500W (cavo avvolgitore).
1.000W (cavo avvolgitore).
IP44.



AVVOLGITORE DI CAVO ELETTRICO

| | | | |
|---------------|------|----|----|
| 51033 | 3,86 | 2 | 54 |
| 62,00€ | Kg | ff | |

Supporto/Avvolgitore di cavo elettrico.
Lunghezza: 25 m.
Cavo H05W-F di 3 x 1,5mm² con rivestimento in PVC.
IP20.
Protezione da sovraccarico.
Protezione infantile.



PROLUNGA ELETTRICA LINEARE

| | | | |
|--------------|------|-----|----|
| 53166 | 0,45 | 5 | 30 |
| 9,50€ | Kg | sub | ff |

3m

| | | | |
|---------------|------|-----|----|
| 53167 | 0,65 | 5 | 20 |
| 12,00€ | Kg | sub | ff |

5m

| | | | | |
|---------------|-----|-----|----|-----|
| 53168 | 1,2 | 5 | 10 | 300 |
| 18,00€ | Kg | sub | ff | |

10m



COMPRESSORE D'ARIA PORTATILE

| | | | | |
|---------------|------|-----|----|-----|
| 53150 | 0,55 | 10 | 40 | 480 |
| 18,50€ | Kg | sub | ff | |

| | | |
|-------|-------|------|
| 120mm | 165mm | 55mm |
|-------|-------|------|

| | | |
|---------|---------|-------|
| 150 PSI | 100 BAR | Ø30mm |
|---------|---------|-------|

| | | | |
|--------|------|-----|----------|
| DC 12V | 100W | 10A | 16 L/min |
|--------|------|-----|----------|

Aplicar a los coches:
turismo, SUV. Etc.



ADATTATORE DI PRESA INGLESE

| | |
|--------------|-----|
| 13816 | 0,5 |
| 0,70€ | Kg |



ADATTATORE PER PLUG USB

| | | |
|--------------|------|-----|
| 13839 | 0,04 | 200 |
| 7,00€ | Kg | ff |



110V / 60HZ

N

VENTILATORE

A PIANTANA

| | | | |
|---------------|-----|----|----|
| 53189 | 7,1 | 1 | 14 |
| 98,50€ | Kg | ff | |

| | | |
|---------|------|---------|
| 132,5cm | 48cm | Ø56,5cm |
|---------|------|---------|

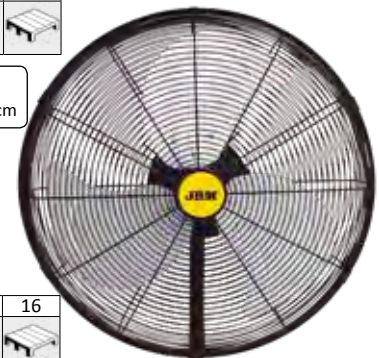

DA TAVOLO

| | | | |
|---------------|-----|----|----|
| 53190 | 6,1 | 1 | 16 |
| 82,50€ | Kg | ff | |

| | | |
|--------|------|-------|
| 57,5cm | 23cm | Ø62cm |
|--------|------|-------|



Tensione (V): 230V
Frequenza (Hz): 50Hz
Potenza (W): 120W
Velocità: 3
Velocità (rpm/min):
1050/1150/1300 rpm/min
Flusso d'aria (CFM):
2700/3000/3400 CFM



ACCESSORI

| | |
|----------------------------------|-----|
| AVVOLGITORI. | 217 |
| ACCESSORI DA OFFICINA. | 218 |
| ORGANIZZATORI | 221 |
| SICUREZZA | 222 |
| KIT DI EMERGENZA | 225 |
| SENSORI DI PARCHEGGIO. | 230 |
| AUTOMOTION. | 231 |
| SPAZZOLE TERGICRISTALLI. | 232 |
| CONTRAPPESO. | 233 |
| VALVOLE TPMS. | 235 |
| PER PNEUMATICI. | 237 |
| TUBI FLESSIBILI. | 241 |



RIFRATTOMETRO PER ALCOL

| | | | |
|----------------|------|----|-----|
| 50731 | 0,56 | 5 | 500 |
| 108,00€ | Kg | ff | ff |

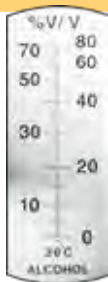

AVVOLGITUBO DELL'ACQUA ATTACCO DA 1/2"

| | | | |
|----------------|------|----|----|
| 50811 | 7,65 | 2 | 14 |
| 130,50€ | Kg | ff | ff |

Supporto/Avvolgitore per tubo dell'acqua
Lunghezza: 15 m + prolunga 2 m
Pressione 10 bar
Attacco da 1/2"
116 PSI
PVC



AVVOLGITUBO DELL'ARIA

Supporto/Avvolgitore per tubo dell'aria
Senza batteria
PVC
Senza elettricità

3/8" Ø 9,5 mm 20 BAR 300 PSI

| | | | |
|----------|---------------|-----|----|
| N | 12m | | |
| | 53532 | 6,2 | 2 |
| | 97,00€ | Kg | ff |

| | | |
|----------------|------|--|
| 12m | | |
| REF. | | |
| 108,00€ | | |
| Kg | 7,12 | |
| ff | 1 | |
| ff | 21 | |

| | | |
|----------------|------|--|
| 20m | | |
| REF. | | |
| 147,50€ | | |
| Kg | 9,05 | |
| ff | 1 | |
| ff | 16 | |



VEDI PAG. 106

AVVOLGITORE DI CAVO ELETTRICO 12m

Lunghezza: 12 m
Cavo: H07RN-F 3G1.5mm

Tensione di funzionamento: 230V - 50Hz
IP44

| | | | |
|----------------|-----|----|----|
| 52429 | 5,1 | 2 | 64 |
| 103,50€ | Kg | ff | ff |

Massima potenza:
3.500W (cavo svolgitore)
1.000W (cavo avvolgitore)



| | | | | |
|----------|----------------|-----|----|-----|
| N | 53526 | 4,7 | 4 | 120 |
| | 108,00€ | Kg | ff | ff |

Massima potenza:
3.000W (cavo avvolgitore)
1.000W (cavo avvolgitore)

VEDI PAG. 215

RIFRATTOMETRO UNIVERSALE

| | | | |
|---------------|----|------|--|
| 52963 | | | |
| 59,50€ | Kg | 0,28 | |
| | ff | 5 | |
| | ff | 20 | |
| | ff | 440 | |



Glicole etilenico: -50°C ~ -0°C
Glicole propilenico: -50°C ~ -0°C
Fluido di pulizia: -40°C ~ -0°C

Adblue: 30% ~ 35%
Fluido di batteria: 1.100 - 1.400 sg/l

TESTER PER LIQUIDO ANTIGELO

| | | | | |
|--------------|------|----|----|-----|
| 53453 | 0,05 | 24 | 96 | 384 |
| 5,00€ | Kg | ff | ff | ff |

-43°C ~ 131°C

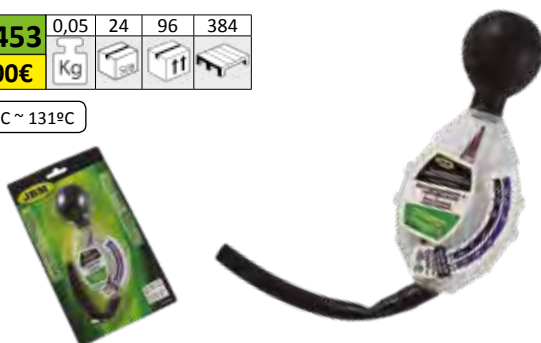

ASPIRATORI DI GAS

| | | | |
|----------------|------|----|----|
| 52824 | 12,5 | 1 | 6 |
| 589,50€ | Kg | ff | ff |

Il gas di scarico pneumatico da collegamento compressore d'aria permette il collegamento diretto al tubo di scarico per inviare l'output di fumo; utile per mantenere ambienti di lavoro sani e in alcuni casi in cui il veicolo non eseguire una corretta combustione e genera fumo eccessivo.
Tubo retrattile, permette la memorizzazione all'interno del corpo pompa per risparmiare spazio di archiviazione.

Lunghezza del tubo termoretraibile: 4 metri.
Capacità di aspirazione: 185 L/min



CANNELLO A GAS

| | | | | |
|---------------|------|----|-----|-----|
| 51920 | 0,15 | 5 | 100 | 900 |
| 20,00€ | Kg | ff | ff | ff |



Gas non incluso



RICAMBIO DI GAS

| | | | |
|---------------|------|----|-------|
| 51986 | 0,18 | 24 | 1.584 |
| 11,00€ | Kg | ff | ff |

200ml



SCALA D'ALLUMINIO

| | | | |
|---------------|----|---|----|
| 50517 | 4 | 3 | 18 |
| 75,00€ | Kg | | |

4 GRADINI
 Altezza totale: 1,30m
 Altezza massima di lavoro: 0,79m

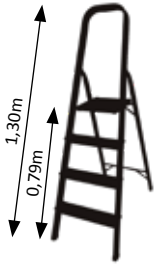

| | | | |
|----------------|-----|---|--|
| 50518 | 4,7 | 3 | |
| 109,00€ | Kg | | |

6 GRADINI
 Altezza totale: 1,91m
 Altezza massima di lavoro: 1,31m

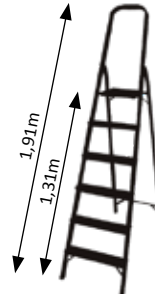

ACCESSORI PER OFFICINA

SCALA TELESCOPICA

| | | | |
|----------------|------|---|----|
| 51982 | 5,51 | 1 | 40 |
| 109,00€ | Kg | | |

Min: 730mm
 Max: 2.000mm

6 GRADINI

| | | | |
|----------------|------|---|----|
| 51983 | 9,41 | 1 | 23 |
| 189,50€ | Kg | | |

Min: 930mm
 Max: 3.200mm

9 GRADINI

| | | | |
|----------------|-------|---|----|
| 51984 | 10,78 | 1 | 21 |
| 203,50€ | Kg | | |

Min: 1.020mm
 Max: 3.800mm

12 GRADINI

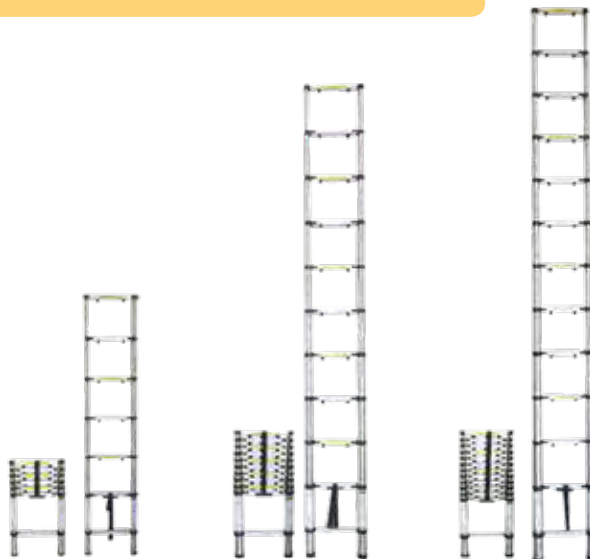

51982

51983

51984

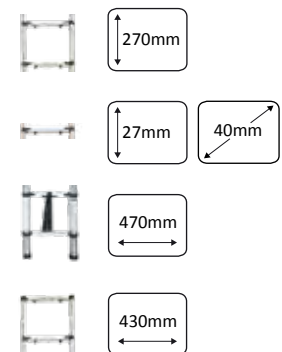

CONFORME ALLE: EN 131

SCALA TELESCOPICA A "V" PIEGHEVOLE

| | | | |
|----------------|-------|---|----|
| 52149 | 13,97 | 1 | 13 |
| 219,00€ | Kg | | |

Scala pieghevole e leggera.
 Sistema di piegatura mediante bloccaggio.
 Fabbricata in alluminio e plastica.

Altezza piegata 835mm
 Altezza estesa: 3800mm
 Altezza spiegata: 1900mm

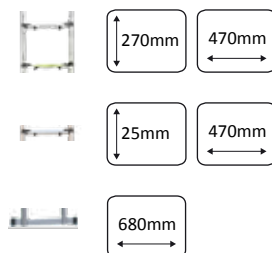

CONFORME ALLE: EN 131

PIATTAFORMA D'ALLUMINIO TELESCOPICA

| | | | |
|----------------|-------|---|----|
| 52230 | 16,75 | 1 | 14 |
| 291,50€ | Kg | | |



Ampiezza della piattaforma: 300mm
 Lunghezza della piattaforma piegata: 1.090mm
 Lunghezza della piattaforma estesa: 1.750mm
 Altezza regolabile della piattaforma: 520-900mm
 Ampiezza dal piolo: 40mm
 Distanza fra i pioli: 250mm

POSIZIONI: 42 (14 da orizzontali x 3 da verticali)
 Altezza 1 : 520mm
 Altezza 2 : 700mm
 Altezza 3 : 900mm

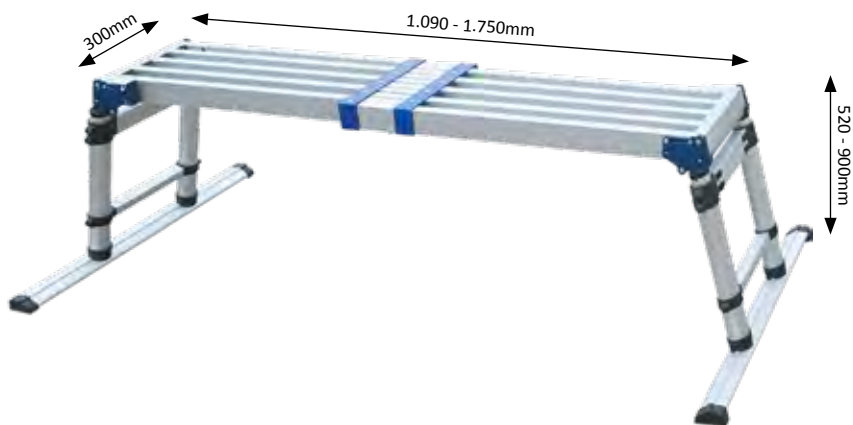

SUPERLEGGERA



FACILE MONTAGGIO

PIEGHEVOLE



10966 11,00€
 PIEDI RICAMBI PER
 PIATTAFORMA REF. 52230

10965 5,50€
 COPRIANGOLO PER
 PIATTAFORMA REF. 52230

10964 6,00€
 BLOCCAPIOLO PER
 PIATTAFORMA REF. 52230

CONFORME ALLE: EN 131

PIATTAFORMA D'ALLUMINIO GRANDE

| | | | |
|----------------|-----|---|----|
| 50913 | 6,5 | 1 | 20 |
| 106,00€ | Kg | | |



| | | |
|-------|---------|-------|
| 800mm | 1.400mm | 300mm |
|-------|---------|-------|

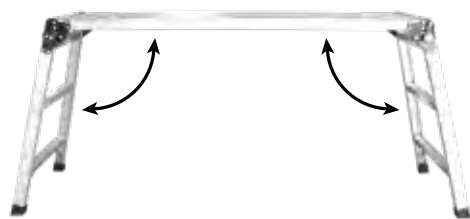

CONFORME ALLE: EN 131

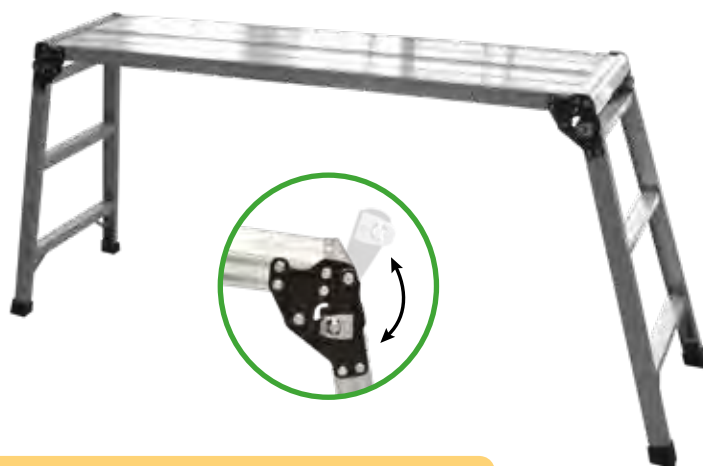

KIT DI 2 PIATTAFORME D'ALLUMINIO

| | | | |
|----------------|-------|---|----|
| 50656 | 10,45 | 1 | 12 |
| 218,00€ | Kg | | |



| | | |
|-------|---------|-------|
| 550mm | 1.300mm | 300mm |
| 300mm | 1.000mm | 300mm |

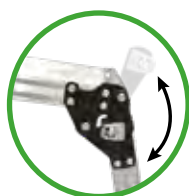
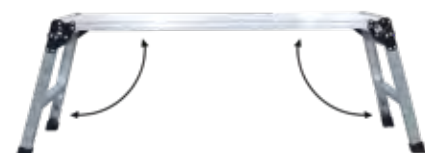

CONFORME ALLE: EN 131

CARRELLO D'ALLUMINIO PIEGHEVOLE ED ESTENSIBILE

| | | | |
|---------------|------|---|----|
| 52201 | 6,18 | 1 | 30 |
| 59,50€ | Kg | | |

90Kg

ESTESO

| | | |
|---------|-------|-------|
| 1.060mm | 380mm | 400mm |
|---------|-------|-------|

PIEGATO

| | | |
|-------|-------|-------|
| 700mm | 400mm | 200mm |
|-------|-------|-------|



CARRELLO D'ACCIAIO BASE

| | | | |
|---------------|------|---|----|
| 52202 | 9,35 | 1 | 10 |
| 66,00€ | Kg | | |

200Kg

| | | |
|-------|-------|-------|
| 110mm | 450mm | 500mm |
|-------|-------|-------|



12055 14,50€

RUOTA PLASTICA
3.00-4 (260x85)
PER REF. 52202



CUSCINETTI INTERNI

13803 8,00€

CAPPELLO DEL CARRETTINO
D'ACCIAIO REF. 52202



CARRO DI PIATTAFORMA

| | | | |
|---------------|----|---|----|
| 52200 | 8 | 1 | 28 |
| 70,50€ | Kg | | |

130Kg

| | | |
|-------|-------|-------|
| 800mm | 720mm | 460mm |
|-------|-------|-------|



CASSETTA CON SCOMPARTIMENTI

| | | | | |
|---------------|------|---|----|--|
| 50958 | 1,89 | 6 | 24 | |
| 33,00€ | Kg | | | |



ORGANIZER A 5 SCOMPARTIMENTI

| | | | | |
|---------------|------|----|----|--|
| 51051 | 1,61 | 12 | 48 | |
| 29,00€ | Kg | | | |

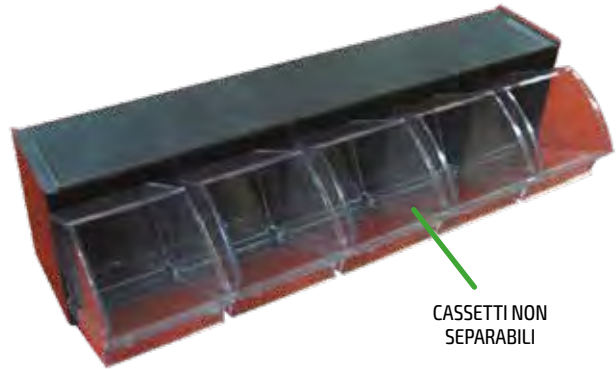

CASSETTI NON SEPARABILI

CASSETTA 24+2 SCOMPARTIMENTI

| | | | | |
|---------------|------|----|----|--|
| 50957 | 1,13 | 12 | 48 | |
| 19,50€ | Kg | | | |

24 scompartimenti da 8 x 5,5 cm.
2 scompartimenti da 15 x 7,5 cm.
Selezionabile da 26 a 5 separazioni.

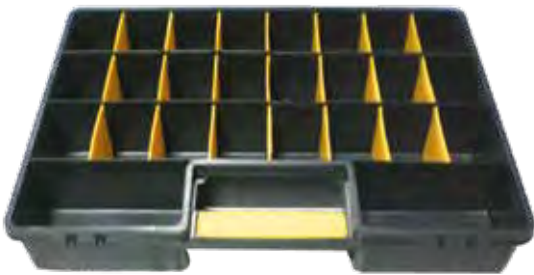

CASSETTA 18+1 SCOMPARTIMENTI

| | | | | |
|---------------|-----|----|-----|--|
| 50959 | 0,7 | 16 | 128 | |
| 12,50€ | Kg | | | |

18 scompartimenti da 6 x 7 cm.
1 scompartimento da 35 x 7 cm.
Selezionabile da 19 a 4 separazioni.



SET DI 8 CONTENITORI IMPILABILI CON GUIDA

| | | | |
|---------------|------|----|-----|
| 50960 | 0,71 | 10 | 120 |
| 17,00€ | Kg | | |

| | |
|--|----------|
| | CASSETTI |
| | GUIDA |



SET DI 4 CASSETTE

| | | | |
|---------------|------|---|----|
| 50961 | 7,75 | 4 | 16 |
| 90,50€ | Kg | | |

MISURE:
15 x 40 x 15 cm
15 scompartimenti
Scompartimenti esterni apribili
18 x 45 x 19 cm
15 scompartimenti
Scompartimenti esterni apribili
23 x 50 x 24 cm
17 scompartimenti
Scompartimenti esterni apribili
28 x 60 x 30 cm
18 scompartimenti
Scompartimenti esterni apribili



ORGANIZER VERTICALE A 47 SCOMPARTIMENTI

| | | | | |
|----------------|------|---|----|--|
| 51050 | 22,5 | 1 | 10 | |
| 238,50€ | Kg | | | |

SCOMPARTIMENTI GRANDI
Totale: 15
Misure:
24x14.5x13 cm
Dimensioni dello scaffale:
84x14x24 cm
Totale scaffali: 3

SCOMPARTIMENTI PICCOLI
Totale: 32
Misure:
16x10x7.5 cm
Dimensioni dello scaffale:
84x16x8 cm
Totale scaffali: 4



CUFFIE DI PROTEZIONE OMOLOGATE

52430

10,50€

Kg 0,34

3x6 6

ff 24

ff 240



ABS

PVC

CONFORME ALLE: EN352 - 1:2003

MASCHERINA DI RESPIRAZIONE

52431

4,00€

| | | | |
|-----------|------------|-----------|-----------|
| 0,05 | 25 | 100 | 800 |
| Kg | 3x6 | ff | ff |

Aerosol non tossici liquidi e solidi in concentrazioni fino a:
4.5 x esposizione professionale di concentrazione massima ammissibile
4.5 x limitare il valore
4.5 x soglia di ancoraggio
20 x protezione valore assegnato



x3

CONFORME ALLE: FFP1

OCCHIALI DI PROTEZIONE

52442

4,50€

| | | | |
|-----------|------------|-----------|-----------|
| 0,06 | 12 | 300 | 1.800 |
| Kg | 3x6 | ff | ff |

52445

4,50€

| | | | |
|-----------|------------|-----------|-----------|
| 0,06 | 12 | 300 | 1.800 |
| Kg | 3x6 | ff | ff |

CE

52442



PC



CE

SOLARE

52445

CONFORME ALLE: EN166:2001

OCCHIALI DI PROTEZIONE SPORT

52440

4,50€

| | | | |
|-----------|------------|-----------|-----------|
| 0,04 | 12 | 300 | 1.800 |
| Kg | 3x6 | ff | ff |

52441

4,50€

| | | | |
|-----------|------------|-----------|-----------|
| 0,04 | 12 | 300 | 1.800 |
| Kg | 3x6 | ff | ff |

Nylon

CE

52440



PC

CE

SOLARE

52441



CONFORME ALLE: EN166:2001

OCCHIALI DI SICUREZZA CON LED DI ILLUMINAZIONE

52701

34,00€

| | | | |
|-----------|------------|-----------|-----------|
| 0,24 | 12 | 40 | 160 |
| Kg | 3x6 | ff | ff |



2 LEDS



CE

CONFORME ALLE: EN166:2001

GUANTI USA ANTI-TAGLIO DIGITALE

| | | | | | |
|--------------|------|-----|-----|-------|-------------|
| 52570 | 0,03 | 12 | 144 | 3.456 | T.8 |
| 2,50€ | Kg | sub | ff | ff | |
| 52571 | 0,03 | 12 | 144 | 2.592 | T.9 |
| 2,50€ | Kg | sub | ff | ff | |
| 52572 | 0,03 | 12 | 144 | 2.592 | T.10 |
| 2,50€ | Kg | sub | ff | ff | |
| 52573 | 0,04 | 12 | 144 | 2.592 | T.11 |
| 2,50€ | Kg | sub | ff | ff | |

CE



GUANTI NITRILE



4.5MIL

| | | | | |
|--------------|------|----|-----|----------|
| 52447 | 0,55 | 10 | 340 | M |
| 8,50€ | Kg | ff | ff | |

| | | | | |
|--------------|------|----|-----|----------|
| 52448 | 0,57 | 10 | 340 | L |
| 9,50€ | Kg | ff | ff | |

| | | | | |
|--------------|------|----|-----|-----------|
| 52449 | 0,64 | 10 | 340 | XL |
| 9,50€ | Kg | ff | ff | |



5.0MIL

| | | | | |
|--------------|------|----|-----|----------|
| 52681 | 0,62 | 10 | 340 | M |
| 9,50€ | Kg | ff | ff | |

| | | | | |
|---------------|------|----|-----|----------|
| 52682 | 0,62 | 10 | 340 | L |
| 10,00€ | Kg | ff | ff | |

| | | | | |
|---------------|------|----|-----|-----------|
| 52683 | 0,67 | 10 | 340 | XL |
| 10,00€ | Kg | ff | ff | |

100 unità per dispenser.
Guanti usa e getta in nitrile di alta qualità.
Ambidestri.
Senza polvere.
Non sterili.



GUANTI CON IL PALMO RINFORZATO IN POLIURETANO



| | | | | |
|--------------|------|----------|-----|-------|
| REF. | 0,03 | 12 | 144 | 3.456 |
| 1,50€ | Kg | UDS PACK | ff | ff |



| | | | |
|---------------|------------|---------------|-------------|
| 51640N | T.8 | 51636N | T.10 |
| 51642N | T.9 | 51638N | T.11 |

GUANTI CON IL PALMO RINFORZATO IN NITRILE

| | | | | |
|--------------|------|----------|-----|-------|
| REF. | 0,04 | 12 | 144 | 3.456 |
| 1,50€ | Kg | UDS PACK | ff | ff |

| | | | |
|--------------|------------|---------------|-------------|
| 51633 | T.8 | 51632N | T.10 |
| 51634 | T.9 | 51398N | T.11 |



GUANTI IN FILO DI COTONE



| | | | | |
|--------------|------|----------|-----|-------|
| 51745 | 0,05 | 12 | 144 | 3.744 |
| 0,53€ | Kg | UDS PACK | ff | ff |

GUANTI IN FILO DI COTONE CON IL PALMO RINFORZATO A PUNTINI

| | | | | |
|--------------|------|----------|-----|-------|
| 51785 | 0,04 | 12 | 300 | 4.200 |
| 0,57€ | Kg | UDS PACK | ff | ff |



PALMO RINFORZATO



GUANTI IN PELLE E TELA

| | | | | |
|--------------|------|-------------|-----|-------|
| 52310 | 0,19 | 12 | 100 | 1.200 |
| 3,50€ | Kg | UDS PACK | | |



CE

GUANTI IN PELLE

| | | | |
|--------------|-----|-----|-------|
| 52738 | 0,1 | 144 | 2.880 |
| 4,00€ | Kg | | |

T.9



| | | | |
|--------------|-----|-----|-------|
| 52739 | 0,1 | 144 | 2.880 |
| 4,00€ | Kg | | |

T.10



CE
EN388: 16
2121X

BORSA MINI 610x150mm

| | | | |
|--------------|------|-----|-------|
| REF. | 0,08 | 100 | 2.800 |
| 2,00€ | Kg | | |

| | | | |
|--------------|--|--------------|--|
| 53242 | | 53244 | |
| 53243 | | 53245 | |



VELCRO

SACCHETTI CON RIVETTO 550 x 90 x 130mm

| | | | | | | | |
|--------------|------|-----|-------|--------------|--|--------------|--|
| REF. | 0,12 | 100 | 1.100 | 51692 | | 51694 | |
| 2,50€ | Kg | | | 51693 | | 51696 | |



VELCRO

SACCHETTI IN PVC 570 x 110 x 65mm

| | | | |
|--------------|------|-----|-------|
| 51691 | 0,18 | 100 | 1.200 |
| 3,00€ | Kg | | |



VELCRO

SACCHETTI 6 COMPARTIMENTI 570 x 100 x 130mm

| | | | |
|--------------|------|-----|-----|
| 51680 | 0,28 | 100 | 800 |
| 3,00€ | Kg | | |

In tessuto "rete" a velcro.
Divisione centrale con 3 scomparti.



VELCRO

SACCHETTI NYLON VERDE SPECIALE 470 x 65 x 140mm

| | | | |
|--------------|------|-----|-------|
| 10945 | 0,12 | 100 | 1.600 |
| 3,00€ | Kg | | |



VELCRO

KIT D'EMERGENZA SICUREZZA

PREZZO PER QUANTITÀ
SERIGRAFIA NON INCLUSA



KIT DI EMERGENZA IN CASSETTA IN PLASTICA

N

| | |
|---------------|-----|
| 53540 | |
| 22,00€ | |
| | 2 |
| | 9 |
| | 126 |



KIT D'EMERGENZA SACCHETTI MINI

| x1 | | x2* | |
|-------|--------|-------|--------|
| 53169 | 12,50€ | 53173 | 16,50€ |
| 53170 | 12,50€ | 53174 | 16,50€ |
| 53171 | 12,50€ | 53175 | 16,50€ |
| 53172 | 12,50€ | 53176 | 16,50€ |

* Doppio triangolo, obbligatorio solo in Spagna.

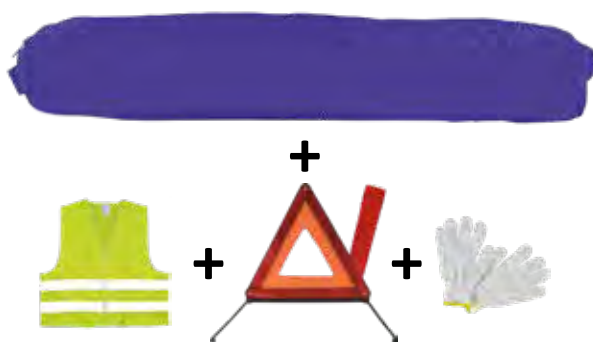

KIT D'EMERGENZA SACCHETTI CON RIVETTO

| x1 | | x2 | |
|-------|--------|-------|--------|
| 53177 | 13,00€ | 53181 | 18,00€ |
| 53178 | 13,00€ | 53182 | 18,00€ |
| 53179 | 13,00€ | 53183 | 18,00€ |
| 53180 | 13,00€ | 53184 | 18,00€ |

KIT D'EMERGENZA SACCHETTI IN PVC

| x1 | | x2 | |
|-------|--------|-------|--------|
| 53185 | 14,50€ | 53186 | 19,00€ |

KIT D'EMERGENZA

MK H1

52768 20,50€

52772 20,50€

52776 20,50€

52780 20,50€

MK H4

52769 20,50€

52773 20,50€

52777 20,50€

52781 20,50€

MK H7

52770 20,50€

52774 20,50€

52778 20,50€

52782 20,50€

MK H7+H1

52771 20,50€

52775 20,50€

52779 20,50€

52783 20,50€



KIT D'EMERGENZA BLU BORSA CON RIVETTO

53087 13,00€

53088 13,00€

53089 13,00€

53090 13,00€



+



KIT D'EMERGENZA BORSA MINI

53091 12,00€

53092 12,00€

53093 12,00€

53094 12,00€



+



TRIANGOLO DI SEGNALAZIONE OMOLOGATO

x1

52795 0,59 20 980
5,50€ Kg 1ff 1ff

x2

52808 0,56 30 1.080
8,50€ Kg 1ff 1ff

53128 0,4 40 1.000
4,00€ Kg 1ff 1ff
27R033977



GIUBBOTTO RIFLETTENTE OMOLOGATO

51817 0,13 100 2.600
4,00€ Kg 1ff 1ff

SEGNATO BANDA

50654 0,13 100 2.600
3,50€ Kg 1ff 1ff

50966 0,13 100 2.600
3,00€ Kg 1ff 1ff



CONFORME ALLE: EN ISO20471:2013

ADATTATORES GLP

EURO CONNECTOR

N



M10

53493 0,2
16,50€ Kg



53494 0,25
19,00€ Kg



53495 0,3
29,00€ Kg



M14

53496 0,2
16,50€ Kg



53497 0,25
19,00€ Kg



53498 0,3
29,00€ Kg



CINTURE DI SICUREZZA PER PULLMAN

CINTURE A 2 PUNTI



125cm

CONFORME ALLE: E4-16R-0436213

50644 0,40 40 1.600
13,00€ Kg

CINTURE A 2 PUNTI
AVVOLGIBILE



133cm

CONFORME ALLE: E4-16R-0436232

50717 0,75 20 500
23,50€ Kg

CINTURE A 3 PUNTI
AVVOLGIBILE



330cm

CONFORME ALLE: E4-16R-0436232

51266 1,13 20 320
30,50€ Kg

CASSETTA DI PRIMO SOCCORSO

51246 0,2 50 600
7,50€ Kg

Contiene:

- 1 Volantino di primo soccorso
- 1 Fobrici
- 1 Paio di guanti di latex
- 2 Cartine all'alcol
- 2 Tiritas adhesivas
- 25gr. de algodón

- 1 Sobre con 5 garze 20x20cm
- 1 Benda
- 1 Rotolo nastro adesivo
- Misure di borsa: 180x130x55mm



KIT EMERGENZA

SET CONTENITORI MULTIFUNZIONE

52618 2,03 6 36
57,50€ Kg



- Composto da 4 pezzi:
- Cassa flessibile con coperchio 37L (300mm x 490mm)
 - Bidone circolare 180mm diam. con copertura (230mm altezza)
 - Portaoggetti a gancio (90mm altezza x 260mm lungo)
 - Vassio rigido (175mm altezza x 300mm lungo)



CARTELLO DI AVVERTIMENTO "CARICO SPORGENTE" V-20

N

| | | | | |
|---------------|------|---|----|-----|
| 53507 | 0,75 | 5 | 25 | 750 |
| 27,00€ | Kg | | | |

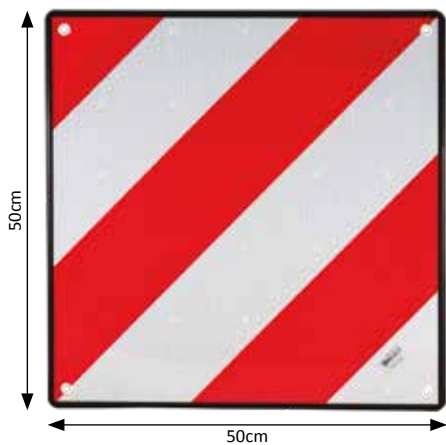

DISTINTIVO PER VEICOLI DESTINATI AL TRASPORTO

| | | | |
|----------------|------|----|-----|
| 51935 | 1,04 | 10 | 280 |
| 156,50€ | Kg | | |

| | | | |
|----------------|------|----|-----|
| 51936 | 1,04 | 10 | 140 |
| 156,50€ | Kg | | |

| | | | |
|----------------|------|----|-----|
| 51937 | 1,03 | 10 | 280 |
| 156,50€ | Kg | | |



Applicabile a partire dal 10 luglio 2011, ai sensi della modifica del Regolamento Generale sui Veicoli, approvato mediante il Regio Decreto 2822/1998 del 23 dicembre 2010.
Bobine indivisibili di 50m.



Omologazione: REGLAMENTO CEPE/ONU 104R

CUNEI FERMAROUTA

N

| | | | | |
|--------------|------|---|----|-----|
| 53508 | 0,35 | 4 | 24 | 288 |
| 9,50€ | Kg | | | |

2 PCS



PALA PIEGHEVOLE

| | | | |
|---------------|------|----|-----|
| 51858 | 0,96 | 20 | 320 |
| 13,00€ | Kg | | |

Fabbricati con metallo resistente.
Piegate: 240mm.
Aperta: 600mm.



PALA ESTENSIBILE IN ALLUMINIO

| | | | |
|---------------|------|---|----|
| 53033 | 0,63 | 5 | 65 |
| 12,00€ | Kg | | |



KIT EMERGENZA

JBM

MULTIUSO CORDA 30M

| | | | | | |
|---------------|----|-----|----|----|--------|
| 53233 | 1 | 6 | 24 | 96 | ∅ 1/2" |
| 18,00€ | Kg | sub | ff | | |

| | | | | | |
|--------------|-----|-----|----|-----|--------|
| 53234 | 0,4 | 6 | 24 | 288 | ∅ 1/4" |
| 8,00€ | Kg | sub | ff | | |



SET 3PCS PANNO IN MICROFIBRA

| | | | | |
|--------------|------|-----|-----|--------------|
| 53221 | 0,03 | 50 | 800 | 3 PCS |
| 4,00€ | Kg | sub | ff | |



PONCHO IMPERMEABILE

| | | | |
|--------------|------|-----|-------|
| 50525 | 0,05 | 250 | 6.250 |
| 0,97€ | Kg | sub | ff |



PISTOLA DI PLASTICA UNIVERSALE PER SPRAY

| | | | |
|--------------|------|-----|-----|
| 52493 | 0,06 | 12 | 100 |
| 4,00€ | Kg | sub | ff |

Può essere utilizzata con la maggior parte spray mercato.



SPRAY PER RIPARARE FORATURE

| | | | |
|--------------|-----|-----|-------|
| 51814 | 0,3 | 12 | 1.320 |
| 9,00€ | Kg | sub | ff |

300 ml

Per fissare la puntura in meno di un minuto senza dover cambiare una ruota o rimuoverlo.



RASCHIETTO TOGLIHIACCIO

| | | | |
|--------------|------|-----|-------|
| 51697 | 0,03 | 300 | 7.500 |
| 0,42€ | Kg | sub | ff |



OMBRELLO PIEGHEVOLE

| | | | |
|--------------|-----|-----|-------|
| 50526 | 0,2 | 100 | 2.000 |
| 4,00€ | Kg | sub | ff |



MINIFORBICI PER CASSETTA DI PRIMO SOCCORSO 9 cm

| | | | | |
|--------------|------|-----|-------|--------|
| 51925 | 0,01 | 200 | 1.000 | 40.000 |
| 1,50€ | Kg | sub | ff | |



MARTELLO D'EMERGENZA ROMPEVETRI CON BASE E TAGLIA-CINTURA DI SICUREZZA

| | | | | |
|--------------|------|-----|-----|-------|
| 52259 | 0,16 | 50 | 100 | 2.000 |
| 3,50€ | Kg | sub | ff | |

| | |
|-------|---------|
| 135mm | 20mm |
| 75mm | ∅ 160mm |

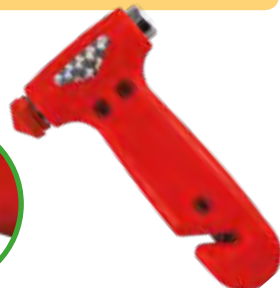

SUPPORTO AUTO PER SMARTPHONE

| | | |
|--------------|------|-----|
| 53443 | 0,05 | 100 |
| 7,00€ | Kg | sub |

min: 55mm
máx: 83mm



GANCIO

ADATTATORE USB PER PRESA ACCENDISIGARI

| | | | |
|--------------|------|-----|-----|
| 13855 | 0,06 | 10 | 100 |
| 7,00€ | Kg | sub | ff |

Ingresso: 12V-24V
Uscita: 5V
1.000mA



| | | | |
|----------------|------|-----|-----|
| N 13815 | 0,06 | 10 | 100 |
| 6,50€ | Kg | sub | ff |

24V, 1A



SENSORI DI PARCHEGGIO CON AVISATORE ACUSTICO 4 CAPSULE - 8 CAPSULE

| | | | | |
|---------------|------|-----|----|-----|
| 52742 | 0,91 | 5 | 20 | 120 |
| 68,50€ | Kg | 5x6 | 11 | 11 |

x8

ANTERIORE + POSTERIORE
Allarme vocale disponibili.
4 sensori posteriori (+ 4 anteriore).
Resistente alla pioggia.
Ricambi disponibili.
VERNICIABILE PINS.



| | | | |
|---------------|------|----|-----|
| 52743 | 0,55 | 20 | 200 |
| 38,50€ | Kg | 11 | 11 |

x4

SENSORI DI PARCHEGGIO CON AVISATORE ACUSTICO E DISPLAY VISIVO LED 4 CAPSULE

| | | | | |
|---------------|------|-----|----|-----|
| 52744 | 0,68 | 10 | 20 | 220 |
| 42,00€ | Kg | 5x6 | 11 | 11 |

LED x4

Tensione: 12 V DC.
Potenza: 3,6 W.
Temperatura di lavoro: Da -20°C a 70°C.
4 sensori ravvicinamento.
Distanza di rilevamento: 0,3 - 2,0 m.
Angolo di rilevamento: H >60°, V >60°.
Radiofrequenza: 315 MHz / 433 MHz.

Angolo di macchina fotografica:
92° o 120°.
Include buzzer 4 centimetri diam.
VERNICIABILE PINS.



SENSORE DI PARCHEGGIO CON AVISATORE ACUSTICO E DISPLAY VISIVO

| | | | |
|---------------|------|----|-----|
| 51863 | 0,63 | 20 | 200 |
| 54,00€ | Kg | 11 | 11 |

PARAMETRI TECNICI:

Tensione: 12 V DC.
Potenza: 3,6 W.
Temperatura di lavoro: Da -20°C a 70°C.
4 sensori ravvicinamento.
Distanza di rilevamento: 0,3 - 2,0 m.
Angolo di rilevamento: H >60°, V >60°.
Radiofrequenza: 315 MHz / 433 MHz.
Angolo di macchina fotografica: 92° o 120°.
Include buzzer 4 centimetri diam.



SENSORE DI PARCHEGGIO CON SOLO AVISATORE ACUSTICO

| | | | |
|---------------|------|----|-----|
| 51973 | 0,54 | 20 | 240 |
| 43,00€ | Kg | 11 | 11 |

PARAMETRI TECNICI:

Tensione: 12 V DC.
Potenza: 3,6 W.
Temperatura di lavoro: Da -20°C a 70°C.
4 sensori ravvicinamento.
Distanza di rilevamento: 0,3 - 2,0 m.
Angolo di rilevamento: H >60°, V >60°.
Radiofrequenza: 315 MHz / 433 MHz.
Angolo di macchina fotografica: 92° o 120°.
Nessun indicatore visivo.
Include buzzer 4 centimetri diam.



PIASTRA PORTATARGA ANONIMA

| | | | |
|--------------|------|-----|-------|
| 51412 | 0,09 | 100 | 3.600 |
| 2,00€ | Kg | 11 | 11 |

Misure: 53,20cm x 13,70cm
Area disponibile: 52cm x 1,60cm

GRAFICA E SERIGRAFIA NON INCLUSA



TAPPETINI UNIVERSALI REVERSIBILI IN GOMMA

| | | | |
|---------------|------|---|-----|
| 50585 | 2,86 | 8 | 208 |
| 11,00€ | | | |

Gomma di alta qualità.
Molto resistenti.
Adattabili alla maggior parte dei veicoli.



METEXP 53,00€

ESPOSITORI PER TAPPETINI



REVERSIBILI!



TAPPETINI UNIVERSALI IN GOMMA

53241

7,00€

1,65

12

288

4 PCS

Gomma di alta qualità.
Molto resistenti.
Adattabili alla maggior parte dei veicoli.

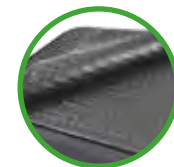

TAPPETINI UNIVERSALI

52530

12,00€

2 8 160



Contiene:
2 Anteriori (390mm)
2 Posteriori (365x480mm)

Leggero, confortevole, con batti tacco in plastica fondo con borchie in gomma.



ESPOSITORI DISPONIBILI



FONDO



TAPPETINI UNIVERSALI

TACCO COLORE ALLUMINIO

52534

13,50€

1,55 8 160



TACCO MOQUETA

52535

10,50€

1,55 8 160



Contiene:
2 Anteriori (425x660mm)
2 Posteriori (295x425mm)

Leggero, confortevole, con tacco plastico reverso con borchie in gomma.



FONDO

EXPOSITOR DISPONIBILE



52534



52535



SPAZZOLA TERGICRISTALLO AEROFLEX UNIVERSALE UNA UNITÀ ESPOSITORE DISPONIBILE

| REF. | DESCRIZIONE |  |  |  |  | € |
|----------|-------------|---|---|---|---|--------|
| JBMWB18S | 18" 450mm | 0,17 | 15 | 60 | 600 | 7,50€ |
| JBMWB19S | 19" 480mm | 0,19 | 15 | 60 | 600 | 8,00€ |
| JBMWB20S | 20" 500mm | 0,19 | 15 | 60 | 600 | 8,00€ |
| JBMWB21S | 21" 530mm | 0,2 | 15 | 60 | 600 | 8,50€ |
| JBMWB22S | 22" 550mm | 0,22 | 15 | 60 | 600 | 9,00€ |
| JBMWB24S | 24" 600mm | 0,22 | 15 | 60 | 600 | 9,50€ |
| JBMWB26S | 26" 650mm | 0,28 | 15 | 60 | 600 | 11,50€ |
| JBMWB28S | 28" 700mm | 0,3 | 15 | 60 | 600 | 13,00€ |

x1



SPAZZOLA TERGICRISTALLO AEROFLEX UNIVERSALE DUE UNITÀ ESPOSITORE DISPONIBILE



| REF. | DESCRIZIONE |  |  |  |  | € |
|---------|-------------|---|---|---|---|--------|
| JBMWB13 | 13" 330mm | 0,2 | 10 | 60 | 720 | 9,00€ |
| JBMWB14 | 14" 350mm | 0,21 | 15 | 60 | 720 | 9,50€ |
| JBMWB15 | 15" 380mm | 0,23 | 15 | 60 | 720 | 10,00€ |
| JBMWB16 | 16" 410mm | 0,25 | 15 | 60 | 720 | 10,50€ |
| JBMWB17 | 17" 430mm | 0,28 | 15 | 60 | 720 | 12,00€ |
| JBMWB18 | 18" 450mm | 0,3 | 15 | 60 | 700 | 12,00€ |
| JBMWB19 | 19" 480mm | 0,32 | 15 | 60 | 600 | 12,50€ |
| JBMWB20 | 20" 510mm | 0,32 | 15 | 60 | 600 | 13,00€ |
| JBMWB21 | 21" 530mm | 0,35 | 15 | 60 | 600 | 14,00€ |
| JBMWB22 | 22" 550mm | 0,37 | 15 | 60 | 600 | 14,00€ |
| JBMWB24 | 24" 600mm | 0,4 | 15 | 60 | 600 | 15,00€ |

x2



SPAZZOLA TERGICRISTALLO AEROFLEX UNIVERSALE INCLUSI 10 ADATTATORI



| | | |
|----------|---|---|
| JBMWBEXP | 1,07 | 10 |
| 16,50€ |  |  |

ESPOSITORI



x1

| REF. | DESCRIZIONE |  |  |  |  | € |
|-------|-------------|---|---|---|---|--------|
| 52394 | 11" 275mm | 0,15 | 10 | 50 | 850 | 9,00€ |
| 52395 | 12" 300mm | 0,15 | 10 | 50 | 850 | 9,00€ |
| 52396 | 13" 325mm | 0,16 | 10 | 50 | 850 | 9,50€ |
| 52397 | 14" 350mm | 0,16 | 10 | 50 | 800 | 9,50€ |
| 52398 | 15" 375mm | 0,18 | 10 | 50 | 800 | 9,50€ |
| 52399 | 16" 400mm | 0,18 | 10 | 50 | 800 | 9,50€ |
| 52400 | 17" 425mm | 0,19 | 10 | 50 | 800 | 10,00€ |
| 52401 | 18" 450mm | 0,2 | 10 | 50 | 800 | 10,50€ |
| 52402 | 19" 475mm | 0,2 | 10 | 50 | 800 | 10,50€ |
| 52403 | 20" 500mm | 0,22 | 10 | 50 | 800 | 11,00€ |
| 52404 | 21" 525mm | 0,22 | 10 | 50 | 700 | 11,00€ |
| 52405 | 22" 550mm | 0,23 | 10 | 50 | 700 | 11,00€ |
| 52406 | 24" 600mm | 0,25 | 10 | 50 | 600 | 12,00€ |
| 52407 | 26" 650mm | 0,25 | 10 | 50 | 600 | 12,00€ |
| 52408 | 28" 700mm | 0,26 | 10 | 50 | 600 | 12,50€ |
| 52409 | 30" 750mm | 0,29 | 10 | 50 | 500 | 15,00€ |

CONTRAPPESO ADESIVO IN BARRETTE DA 45g. (STRISCE DI 5g - 10g - 5g - 10g - 5g - 10g)

| | | | | |
|--------------|------|-----|------|--------|
| 50600 | 0,05 | 100 | 400 | 16.000 |
| 0,73€ | Kg | 50g | 100g | 1000g |

| | | | | |
|--------------|------|-----|------|--------|
| 50601 | 0,05 | 100 | 400 | 38.400 |
| 0,22€ | Kg | 50g | 100g | 1000g |



ZINC
50600



FERRO
50601

PINZA SPECIALE PER CONTRAPPESI

| | | | | |
|---------------|------|-----|------|-------|
| 51355 | 0,45 | 5 | 50 | 500 |
| 16,50€ | Kg | 50g | 100g | 1000g |

Toglie facilmente e sostituisce i contrappesi.
Taglia e piega con facilità.
Realizzata in acciaio temperato.
Include manico ergonomico.
Con molle automatiche in aperto ne' l'impugnatura per agevolarne l'uso.



CONTRAPPESO ADESIVO IN BARRETTE 60g

| | | | | |
|--------------|------|-----|------|--------|
| 52665 | 0,06 | 100 | 400 | 33.200 |
| 0,29€ | Kg | 50g | 100g | 1000g |

| | | | | |
|--------------|------|-----|------|--------|
| 52666 | 0,06 | 100 | 400 | 30.000 |
| 0,29€ | Kg | 50g | 100g | 1000g |



Adesivo grande aderenza e durata.



Adesivo grande aderenza e durata.



CONTRAPPESO A GRAFFA IN ZINCO SPECIALE CERCHIO UNIVERSALE

| REF. | g. | Kg | 50g | 100g | 1000g | € |
|-------|-----|------|-----|-------|--------|-------|
| 50760 | 5g | 0,01 | 100 | 1.600 | 20.000 | 0,10€ |
| 50761 | 10g | 0,01 | 100 | 1.600 | 29.600 | 0,13€ |
| 50762 | 15g | 0,02 | 100 | 800 | 29.200 | 0,22€ |
| 50763 | 20g | 0,02 | 100 | 800 | 30.000 | 0,28€ |
| 50764 | 25g | 0,03 | 100 | 800 | 20.000 | 0,34€ |
| 50765 | 30g | 0,03 | 100 | 600 | 20.000 | 0,40€ |
| 50766 | 35g | 0,04 | 100 | 400 | 10.000 | 0,47€ |
| 50767 | 40g | 0,04 | 100 | 400 | 12.400 | 0,56€ |
| 50768 | 45g | 0,05 | 100 | 400 | 2.250 | 0,59€ |
| 51055 | 50g | 0,05 | 100 | 400 | 2.000 | 0,70€ |



CONTRAPPESO A GRAFFA IN ZINCO SPECIALE CERCHIO FRANCESE

| REF. | g. | Kg | 50g | 100g | 1000g | € |
|-------|-----|------|-----|-------|--------|-------|
| 50769 | 5g | 0,01 | 100 | 1.600 | 20.000 | 0,10€ |
| 50770 | 10g | 0,01 | 100 | 1.600 | 10.000 | 0,14€ |
| 50771 | 15g | 0,03 | 100 | 1.200 | 6.600 | 0,21€ |
| 50772 | 20g | 0,02 | 100 | 800 | 5.000 | 0,28€ |
| 50773 | 25g | 0,03 | 100 | 800 | 4.000 | 0,33€ |
| 50774 | 30g | 0,03 | 100 | 600 | 3.300 | 0,43€ |
| 50775 | 35g | 0,04 | 100 | 400 | 2.850 | 0,48€ |
| 50776 | 40g | 0,04 | 100 | 400 | 2.500 | 0,51€ |
| 50777 | 45g | 0,05 | 100 | 400 | 2.250 | 0,58€ |
| 51056 | 50g | 0,05 | 100 | 400 | 2.000 | 0,70€ |



CONTRAPPESO A GRAFFA IN ZINCO SPECIALE CERCHIO IN LEGA

| REF. | g. | Kg | 50g | 100g | 1000g | € |
|-------|-----|------|-----|-------|--------|-------|
| 50778 | 5g | 0,01 | 100 | 1.600 | 20.000 | 0,10€ |
| 50779 | 10g | 0,01 | 100 | 1.600 | 10.000 | 0,13€ |
| 50780 | 15g | 0,02 | 100 | 1.200 | 6.600 | 0,21€ |
| 50781 | 20g | 0,02 | 100 | 800 | 5.000 | 0,28€ |
| 50782 | 25g | 0,03 | 100 | 800 | 4.000 | 0,33€ |
| 50783 | 30g | 0,03 | 100 | 600 | 3.300 | 0,40€ |
| 50784 | 35g | 0,04 | 100 | 400 | 2.850 | 0,48€ |
| 50785 | 40g | 0,04 | 100 | 400 | 2.500 | 0,56€ |
| 50786 | 45g | 0,05 | 100 | 400 | 2.250 | 0,65€ |
| 51604 | 50g | 0,05 | 100 | 400 | 2.000 | 0,70€ |



DISPENSER DI CONTRAPPESI ADESIVI

1.000 barrette da 5g di contrappesi in ferro adesivo di 4 mm di spessore.
Dimensioni del dispenser: 29,5 cm x 29,5 cm

| | | | |
|---------------|------|---|-----|
| 51908 | 5,82 | 4 | 204 |
| 43,00€ | | | |

Con magneti di trattenimento di quelli da non utilizzare.



53256

26,50€

| | |
|--|-----|
| | 5,3 |
| | 4 |
| | 216 |



N

VALIGETTA DI CONTRAPPESI ASSORTITI

| | | | | |
|----------------|-------|----|---|----|
| 50938 | 13,63 | 50 | 1 | 52 |
| 158,50€ | | | | |

80mm

CONTRAPPESO EXTRAPIATTO IN FERRO ADESIVO 45g - 100u.

450mm



320mm

CONTRAPPESO IN ZINCO CON GRAFFA

| | SERIE A | SERIE B | SERIE C |
|--------------------|-------------|---------------|-------------|
| CERCHIO UNIVERSALE | 5g: 20 uds | 5g: 20 uds | 5g: 20 uds |
| | 10g: 20 uds | 10g: 20 uds | 10g: 20 uds |
| | 15g: 20 uds | 15g: 20 uds | 15g: 20 uds |
| | 20g: 20 uds | zz20g: 20 uds | 20g: 20 uds |
| | 25g: 20 uds | 25g: 20 uds | 25g: 20 uds |
| | 30g: 10 uds | 30g: 10 uds | 30g: 10 uds |
| | 35g: 10 uds | 35g: 10 uds | 35g: 10 uds |
| CERCHIO FRANCESE | 40g: 10 uds | 40g: 10 uds | |
| | | | |
| CERCHIO IN LEGA | | | 40g: 10 uds |
| | | | |
| | | | |
| | | | |
| | | | |
| | | | |



CONTRAPPESO UNIVERSALE CAMION

SEGMENTAZIONE DE 50g

| | | | | |
|--------------|------|----|-----|--------|
| 52667 | 0,05 | 50 | 400 | 25.600 |
| 0,70€ | | | | |

SEGMENTAZIONE DE 100g

| | | | | |
|--------------|-----|----|-----|--------|
| 52668 | 0,1 | 25 | 200 | 12.800 |
| 1,50€ | | | | |

SEGMENTAZIONE DE 150g

| | | | | |
|--------------|------|----|-----|--------|
| 52669 | 0,15 | 20 | 160 | 10.240 |
| 2,00€ | | | | |

SEGMENTAZIONE DE 200g

| | | | | |
|--------------|-----|----|----|-------|
| 52670 | 0,2 | 10 | 80 | 5.120 |
| 3,00€ | | | | |

SEGMENTAZIONE DE 250g

| | | | | |
|--------------|------|----|----|-------|
| 52671 | 0,25 | 10 | 80 | 5.120 |
| 3,50€ | | | | |

SEGMENTAZIONE DE 300g

| | | | | |
|--------------|-----|----|----|-------|
| 52672 | 0,3 | 10 | 80 | 5.120 |
| 4,00€ | | | | |



52667



52668



52669



52670



52671



52672

SET DI RIPARAZIONE VALVOLE TPMS

| | | | |
|----------------|------|---|-----|
| 52855 | 1,63 | 6 | 156 |
| 319,00€ | Kg | | |



COPRE IL 95% DEI VEICOLI SUL MERCATO

Tutte le applicazioni sul nostro sito:
www.jbmcamp.com



CONTENUTO

12909 4.25 Nm



OE 72-20-207, TPK65656

12905 6 Nm



OE 72-20-208, TPK65657

12913 8 Nm



OE 72-20-209, TPK65658

12903 8 Nm



OE 72-20-219, TPK66138

12912 8 Nm



OE 72-20-212, TPK65961

12911 6 Nm

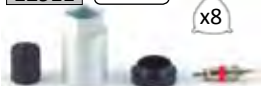

TPK65962

12907 8 Nm

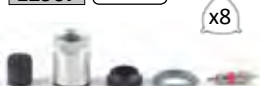

OE 72-20-210, TPK65659

12906 8 Nm

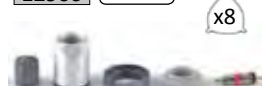

OE 72-20-216, TPK66070, 7020K

12904 6 Nm



OE 72-20-211, TPK65660

12916 1.4 Nm (nut)



OE 72-20-101

12919 4 Nm

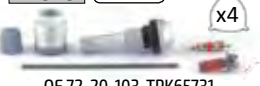

OE 72-20-103, TPK65731

12922 6.0 Nm



OE 72-20-403, TPK43171

12921 6.0 Nm

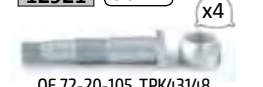

OE 72-20-105, TPK43148

12917 6 Nm



OE TPK66086

12914 8 Nm

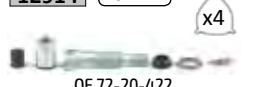

OE 72-20-422

12948 1-1400-1



x25

12949 2-128



x25



RICAMBI DISPONIBILI

| REF. | DESCRIZIONE | | € |
|--------------|----------------------------|------|--------------|
| 12903 | VDO TG1B - 8Nm | 0,01 | 6,50€ |
| 12904 | PACIFIC- LEXUS/TOYOTA- 6Nm | 0,01 | 6,50€ |
| 12905 | SCH GEN 2/3 - 6Nm | 0,01 | 6,50€ |
| 12906 | VDO TG1C - 8Nm | 0,01 | 6,50€ |
| 12907 | VDO TG1B - 8Nm | 0,01 | 6,50€ |
| 12909 | SCH GEN 2/3 - 4.25Nm | 0,01 | 6,50€ |

| REF. | DESCRIZIONE | | € |
|--------------|--------------------------|------|---------------|
| 12911 | SCH GEN ALPHA - 6Nm | 0,01 | 6,50€ |
| 12912 | SCH GEN 2/3 - 8Nm | 0,01 | 6,50€ |
| 12913 | VDO TG1B- 8Nm | 0,01 | 6,50€ |
| 12914 | SENSOR VDO TG 18 - 8Nm | 0,02 | 11,00€ |
| 12916 | SENSOR SCH REV 4 - 1.4Nm | 0,02 | 7,50€ |
| 12917 | SENSOR SCH REV 4- 6Nm | 0,02 | 11,00€ |

| REF. | DESCRIZIONE | | € |
|--------------|--|------|---------------|
| 12919 | SENSOR HUF - Nut Torque: 4.0Nm / Screw Torque: 4.0Nm | 0,02 | 11,00€ |
| 12921 | SENSOR GEN ALPHA- 6Nm | 0,02 | 11,00€ |
| 12922 | SENSOR VDO TG1C - 6.0Nm | 0,01 | 11,00€ |
| 12948 | OBUSES TPMS | - | 25,00€ |
| 12949 | TAPOMI TPMS | - | 25,00€ |

ACCESSORI ANCHE DISPONIBILI

| | | | |
|--------------|------|---|-----|
| 12902 | 0,01 | 4 | 100 |
| 6,50€ | Kg | | |

4.25 Nm OE 72-20-223



| | | | |
|--------------|------|---|-----|
| 12908 | 0,01 | 4 | 100 |
| 6,50€ | Kg | | |

4.25 Nm OE 72-20-205, TPK65654



| | | | |
|--------------|------|---|-----|
| 12910 | 0,01 | 4 | 100 |
| 6,50€ | Kg | | |

7.5 Nm OE 72-20-206, TPK65655



| | | | |
|---------------|------|---|-----|
| 12915 | 0,04 | 4 | 100 |
| 17,50€ | Kg | | |

8 Nm (nut) 1.4 Nm (screw)

OE 72-20-116



| | | | |
|---------------|------|---|-----|
| 12918 | 0,02 | 4 | 100 |
| 11,00€ | Kg | | |

6 Nm OE 72-20-102, TPK65661



| | | | |
|---------------|------|---|-----|
| 12920 | 0,02 | 4 | 100 |
| 11,00€ | Kg | | |

4 Nm (nut) 4 Nm (screw)



| | | | |
|---------------|------|---|-----|
| 12923 | 0,01 | 4 | 100 |
| 11,00€ | Kg | | |

8 Nm OE TPK43211



| | | | |
|--------------|------|---|-----|
| 12924 | 0,01 | 4 | 100 |
| 6,50€ | Kg | | |

4.0 Nm (nut) 1.4 Nm (screw)



| | | | |
|---------------|------|---|-----|
| 12925 | 0,02 | 4 | 100 |
| 11,00€ | Kg | | |



KIT PER IL MONTAGGIO E RIMOZIONE VALVOLE TPMS

| | | |
|----------------|------|----|
| 52818 | 1,38 | 10 |
| 185,00€ | Kg | ff |

Astuccio dedicato per facilitare montaggio e smontaggio dei sensori TPMS.

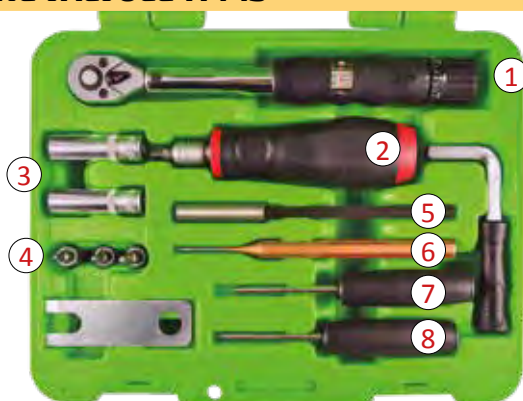

- ① 2-14 Nm
- ② 0,5-3,5 Nm
- ③ 2 x 11, 12mm
- ④ 3 x T10, T15, T20
- ⑤ 150 mm
- ⑥ 2 mm
- ⑦ 0,25 Nm
- ⑧ 0,45 Nm

SENSOR TPMS

EU-PRO 1

| | | | | |
|---------------|------|-----|----|-------|
| 52856 | 0,04 | 1 | 4 | 1.500 |
| 68,50€ | Kg | sub | ff | ff |

Facile programmazione.
Utile per il 98% della flotta di veicoli sul mercato.



EU-PRO 2

| | | | |
|---------------|------|----|-------|
| 53157 | 0,04 | 50 | 1.000 |
| 68,50€ | Kg | ff | ff |

Facile programmazione.
Utile per il 98% della flotta di veicoli sul mercato.

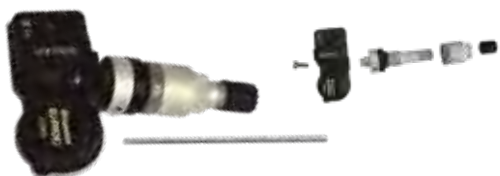

SENSORI TPMS VALVOLA DI GOMMA

EU-PRO 1

| | | |
|---------------|------|----|
| 53424 | 0,04 | 4 |
| 68,50€ | Kg | ff |

Facile da programmare.
Utile per il 98% della flotta di veicoli sul mercato.
Richiede uno strumento di diagnostica TPMS per configurare il sensore per il veicolo richiesto.



Coppia di serraggio: Snap In
Coppia di serraggio: 1,4 Nm

EU-PRO 2

| | | |
|---------------|------|----|
| 53425 | 0,04 | 4 |
| 68,50€ | Kg | ff |

Facile da programmare.
Utile per il 98% della flotta di veicoli sul mercato.
Richiede uno strumento di diagnostica TPMS per configurare il sensore per il veicolo richiesto.



Coppia di serraggio: Snap In
Coppia di serraggio: 1,4 Nm

VALVOLE TPMS

STRUMENTO PER INSTALLARE NUCLEO VALVOLE

| | | | | |
|--------------|------|-----|-----|-------|
| 52653 | 0,04 | 10 | 250 | 6.000 |
| 3,50€ | Kg | sub | ff | ff |

Per installare e disinstallare OBICI.



CHIAVE MULTIFUNZIONI PER NUCLEO VALVOLE

| | | | | |
|--------------|------|-----|-----|-------|
| 52652 | 0,03 | 25 | 100 | 7.200 |
| 3,50€ | Kg | sub | ff | ff |



| | | | |
|--------------|------|-----|-----|
| 52651 | 0,06 | 25 | 100 |
| 4,50€ | Kg | sub | ff |



SET DI TAPPI E NUCLEI PER VALVOLE PNEUMATICHE

| | | | |
|---------------|------|----|-----|
| 52673 | 0,23 | 25 | 875 |
| 20,00€ | Kg | ff | ff |



CONTENUTO

- 11903** Sacco 16 unità tappo di alluminio valvola pneumatici **5,50€**
- 11904** Sacco 50 unità tappo di plastica verde valvola pneumatici **2,00€**
- 11905** Sacco 50 unità tappo di plastica nera valvola pneumatici **2,00€**
- 11906** Sacco 50 unità di nuclei standard **7,00€**
- 11907** Sacco 50 unità di nuclei alta pressione **12,50€**
- 11960** Extrator nuclei **2,00€**

DISPONIBILE ANCHE

- 11900** Tappo di alluminio per valvola pneumatici **3,50€**
Blister 4 unità
- 11901** Tappo di plastica verde per valvola pneumatici **2,00€**
Blister 4 unità
- 11902** Tappo di plastica nera per valvola pneumatici **2,00€**
Blister 4 unità

SET DI RIPARAZIONE PNEUMATICI

| | | | |
|---------------|------|----|-----|
| 52662 | 0,66 | 10 | 440 |
| 33,00€ | | | |



- 1 x Punta di trivello
- 1 x Trivella de inserire stoppini
- 1 x Utile per gonfiare pneumatici
- 4 x Bombole 16gr
- 1 x Fresa
- 10 x Stoppini
- 1 x Chiave obici multifunzione

| | | | |
|---------------|------|----|-----|
| 52663 | 1,23 | 10 | 320 |
| 30,00€ | | | |



- 1 x Trivella de inserire stoppini
- 1 x Punta di trivello de inserire stoppini
- 1 x Trivella di perforazione
- 1 x Fresa
- 20 x Stoppini
- 1 x Lubrificanti

STOPPINO DI RICAMBIO
PER REF. 52662/52663

| | |
|--------------|-----------|
| 12973 | |
| 0,64€ | x5 |

COCLEA PERFORANTE PER REF.
52663

| | |
|---------------|--|
| 13806 | |
| 11,00€ | |

VITE PER INSERIMENTO DELLA
MICCIA REF. 52663

| | |
|---------------|--|
| 13805 | |
| 11,00€ | |

STRUMENTO PER CAMBIO GOMME PER RIMUOVERE PNEUMATICI

| | | | |
|---------------|------|----|-----|
| 52657 | 0,18 | 20 | 800 |
| 42,00€ | | | |



| | | | |
|---------------|------|----|-----|
| 52658 | 0,16 | 20 | 800 |
| 42,00€ | | | |



| | | |
|---------------|------|----|
| 52659 | 0,26 | 20 |
| 42,00€ | | |



LEVA PLASTICA PER RIMUOVERE PNEUMATICI

| | |
|---------------|-------|
| 52655 | |
| 38,00€ | |
| | 0,39 |
| | 25 |
| | 1.500 |



| | |
|---------------|-----|
| 52656 | |
| 28,50€ | |
| | 0,4 |
| | 5 |
| | 20 |



LEVA PER TOGLIERE IL PNEUMATICO DAL CERCHIO

| | |
|--------------|------|
| 51362 | |
| 3,50€ | |
| | 0,19 |
| | 5 |
| | 60 |
| | 500 |

30,48cm
12"

| | |
|--------------|-------|
| 51358 | |
| 8,50€ | |
| | 0,50 |
| | 6 |
| | 24 |
| | 1.008 |

40,64cm
16"

| | |
|--------------|-------|
| 51359 | |
| 9,00€ | |
| | 0,66 |
| | 5 |
| | 24 |
| | 1.008 |

60,96cm
24"



PER PNEUMATICI

VALVOLE PER CERCHI



TR413

| | | | | |
|--------------|------|-----|-------|--------|
| 51741 | 0,01 | 100 | 1.000 | 48.000 |
| 0,35€ | Kg | | | |



TR414

| | | | | |
|--------------|------|-----|-------|--------|
| 51742 | 0,01 | 100 | 1.000 | 48.000 |
| 0,43€ | Kg | | | |



TR418

| | | | | |
|--------------|------|-----|-------|--------|
| 51743 | 0,01 | 100 | 1.000 | 48.000 |
| 0,56€ | Kg | | | |

STRUMENTO PER INSTALLARE VALVOLE

IN METALLO

| | |
|--------------|-------|
| 52649 | |
| 5,50€ | |
| Kg | 0,32 |
| | 10 |
| | 50 |
| | 2.250 |



IN PLASTICA

| | |
|--------------|-------|
| 52650 | |
| 5,50€ | |
| Kg | 0,12 |
| | 10 |
| | 100 |
| | 2.400 |



Per installare valvole pneumatici di auto.

STRUMENTO REPARAZIONE MULTIUSE

| | | | | |
|--------------|------|----|-----|-----|
| 52654 | 0,24 | 25 | 100 | 800 |
| 7,00€ | Kg | | | |

Chiavi Allen: 4 - 3 - 2,5 - 2mm.
Chiave 12-P: 9, 10, 12, 13, 15mm.
Cacciaviti PH1.
Cacciaviti SL1.
Punta allen 5 - 6mm.
Bussole de 6mm.



RULLO PER RIPARAZIONE DI PNEUMATICI

| | | | | |
|--------------|------|----|-----|-------|
| 52842 | 0,15 | 10 | 100 | 1.500 |
| 7,50€ | Kg | | | |



KIT DI PROTEZIONI PER CERCHI DI RUOTA

| | | | | |
|--------------|-----|----|-----|-----|
| 53419 | 0,1 | 10 | 100 | 600 |
| 9,00€ | Kg | | | |



CHIAVE A CROCE FISSATA MECCANICAMENTE

| | | | | |
|---------------|------|---|----|-----|
| 51661 | 1,17 | 5 | 20 | 480 |
| 10,00€ | Kg | | | |

1/2"

17, 19, 21mm

355mm

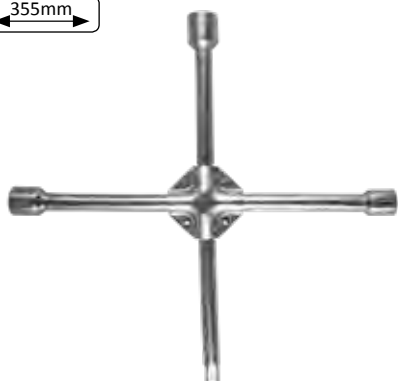

| | | | |
|---------------|-----|----|-----|
| 52881 | 1,4 | 10 | 420 |
| 13,50€ | Kg | | |

1/2"

17, 19, 21, 22mm

400mm

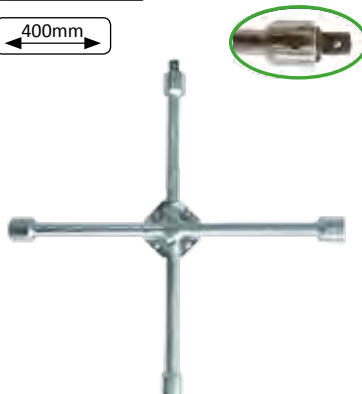

| | | | |
|---------------|------|---|-----|
| 52880 | 3,75 | 5 | 100 |
| 27,50€ | Kg | | |

3/4"

24, 27, 32mm

700mm



PER PNEUMATICI

CHIAVE TELESCOPICA BULLONI RUOTA CON BUSSOLE REVERSIBILI

| | | | | |
|---------------|------|-----|-----|-----|
| 51416 | 1,09 | 10 | 20 | 600 |
| 10,00€ | Kg | 3x6 | 1f1 | 1f1 |

330-490mm
1/2"



Torx Cromata
17mm /19mm



Cromata
21mm /23mm

LEVA PER IL CAMBIO DI PNEUMATICI INDUSTRIALI

| | | | |
|----------------|------|-----|-----|
| 52664 | 12,3 | 2 | 18 |
| 218,00€ | Kg | 1f1 | 1f1 |



CARRELLO PORTA PNEUMATICI

| | | | |
|---------------|------|-----|-----|
| 52660 | 7,88 | 1 | 18 |
| 75,00€ | Kg | 1f1 | 1f1 |

100Kg



HIGH CAPACITY

| | | | |
|----------------|------|-----|-----|
| 52661 | 19,4 | 1 | 10 |
| 247,50€ | Kg | 1f1 | 1f1 |

300Kg



SMONTA PNEUMATICI PORTATILE

| | | | |
|----------------|----|-----|-----|
| 52552 | 12 | 1 | 30 |
| 203,50€ | Kg | 1f1 | 1f1 |



18L



UGELLO DI RICAMBIO
PER REF. 52552

13741 **23,50€**



UTENSILE PER IL MONTAGGIO DI CUFFIE SEMIASSE

| | | | | |
|---------------|------|-----|-----|-----|
| 52829 | 0,43 | 10 | 20 | 200 |
| 20,00€ | Kg | 3x6 | 1f1 | 1f1 |

ESTERNO

Ø 10cm

INTERNI

Ø 9,5cm



UTENSILE PNEUMATICO PER IL MONTAGGIO DI CUFFIE SEMIASSE

| | | | | |
|----------------|------|-----|-----|-----|
| 51861 | 4,08 | 1 | 2 | 32 |
| 163,00€ | Kg | 3x6 | 1f1 | 1f1 |

9 bar
(125 PSI)

Materiale: Alluminio
Apertura da 20 a 100 mm



KIT SPECIALE SOFFIETTO

| | | |
|-----------------|-------|----|
| SERIE124 | 20,94 | 20 |
| 438,00€ | Kg | |

13879
SACCHETTO GRASSO
SOFFIETTO



51861 x1

52633 x100

13738 x100

13879 x100

KIT DI CUFFIE PER SEMIASSE 100% NEOPRENE UNIVERSALI

PER AUTO

| | | | | |
|--------------|------|---|----|-----|
| 51705 | 0,23 | 1 | 20 | 320 |
| 6,50€ | Kg | | | |

13738 **3,50€**

RICAMBIO PER
REF. 51705

PER FURGONI

| | | | |
|--------------|------|----|-----|
| 51703 | 0,28 | 20 | 280 |
| 8,50€ | Kg | | |

13739 **5,50€**

RICAMBIO PER
REF. 51703

KIT SOFFIETTO UNIVERSALE

| | | | |
|--------------|------|----|-----|
| 52644 | 0,19 | 20 | 240 |
| 7,50€ | Kg | | |

NEOPRENO

11922 **5,50€**

RICAMBIO PER REF. 52644

13880

GRASSO PER CUFFIA UNIVERSALE
GIUNTO STERZO

FASCETTE STRINGITUBO

| | |
|--------------|-------|
| 11891 | x50 |
| 0,46€ | |
| Kg | 0,01 |
| | 100 |
| | 5.000 |



| | |
|--------------|--------|
| 11890 | x50 |
| 0,59€ | |
| Kg | 0,02 |
| | 100 |
| | 1.000 |
| | 20.000 |



PACK 2 FASCETTE STRINGITUBO

| | | | | |
|--------------|------|-----|-----|--------|
| 52633 | 0,02 | 100 | 800 | 16.000 |
| 0,88€ | Kg | | | |

UTILIZZARE CON PINZE
REF. 52619



CILINDRO CENTRALE

| | | | | |
|--------------|------|----|-------|--------|
| 52645 | 0,02 | 50 | 1.000 | 38.000 |
| 0,42€ | Kg | | | |

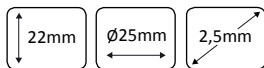

| | | | | |
|--------------|------|----|-------|--------|
| 52646 | 0,01 | 50 | 1.000 | 80.000 |
| 0,35€ | Kg | | | |

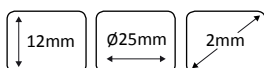

| | | | |
|--------------|------|----|-------|
| 53037 | 0,01 | 50 | 1.000 |
| 0,33€ | Kg | | |

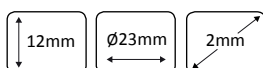

| | | | |
|--------------|------|----|-------|
| 53038 | 0,01 | 50 | 1.000 |
| 0,33€ | Kg | | |

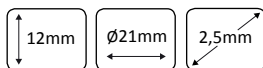

| | | | |
|--------------|------|----|-------|
| 53039 | 0,02 | 50 | 1.000 |
| 0,39€ | Kg | | |

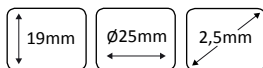

| | | | |
|--------------|------|----|-------|
| 53040 | 0,01 | 50 | 1.000 |
| 0,33€ | Kg | | |

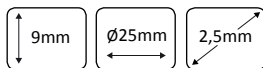

PER PNEUMATICI

TUBI FLESSIBILI INNERBRAID



DISPONIBILE IN
SCATOLA SINGOLA

| REF. | DESCRIZIONE | Kg | ft | € | |
|-------|----------------------------------|------|----|-------|--------|
| 51706 | Tubi flessibili Ø 25mmL x 300mmL | 0,27 | 25 | 1.500 | 20,00€ |
| 51707 | Tubi flessibili Ø 45mmL x 100mmL | 0,27 | 25 | 1.200 | 12,00€ |
| 51708 | Tubi flessibili Ø 45mmL x 150mmL | 0,41 | 25 | 900 | 15,50€ |
| 51709 | Tubi flessibili Ø 45mmL x 200mmL | 0,49 | 25 | 750 | 18,50€ |
| 51710 | Tubi flessibili Ø 45mmL x 250mmL | 0,65 | 25 | 600 | 23,00€ |
| 51711 | Tubi flessibili Ø 45mmL x 300mmL | 0,81 | 25 | 450 | 26,50€ |
| 51712 | Tubi flessibili Ø 50mmL x 100mmL | 0,26 | 25 | 700 | 13,50€ |
| 51713 | Tubi flessibili Ø 50mmL x 150mmL | 0,46 | 25 | 700 | 16,50€ |
| 51714 | Tubi flessibili Ø 50mmL x 200mmL | 0,59 | 25 | 600 | 22,00€ |
| 51715 | Tubi flessibili Ø 50mmL x 250mmL | 0,73 | 25 | 600 | 25,50€ |
| 51716 | Tubi flessibili Ø 50mmL x 300mmL | 0,83 | 25 | 450 | 31,00€ |
| 51717 | Tubi flessibili Ø 55mmL x 100mmL | 0,35 | 25 | 700 | 15,50€ |
| 51718 | Tubi flessibili Ø 55mmL x 150mmL | 0,47 | 25 | 450 | 19,00€ |
| 51719 | Tubi flessibili Ø 55mmL x 200mmL | 0,63 | 25 | 350 | 25,50€ |
| 51720 | Tubi flessibili Ø 55mmL x 250mmL | 0,82 | 25 | 350 | 28,50€ |
| 51721 | Tubi flessibili Ø 55mmL x 300mmL | 0,88 | 25 | 375 | 32,00€ |
| 51722 | Tubi flessibili Ø 60mmL x 100mmL | 0,37 | 25 | 700 | 18,00€ |
| 51723 | Tubi flessibili Ø 60mmL x 150mmL | 0,5 | 25 | 500 | 22,00€ |
| 51724 | Tubi flessibili Ø 60mmL x 200mmL | 0,64 | 25 | 400 | 27,50€ |
| 51725 | Tubi flessibili Ø 60mmL x 250mmL | 0,79 | 25 | 300 | 35,50€ |
| 51726 | Tubi flessibili Ø 60mmL x 300mmL | 0,96 | 25 | 250 | 35,50€ |
| 51727 | Tubi flessibili Ø 60mmL x 400mmL | 1,62 | 25 | 200 | 44,00€ |

CATALIZZATORE PER BENZINA

CATALIZZATORE UNIVERSALE PIATTO FINCHÉ 2.0CC



CATALIZZATORE UNIVERSALE PIATTO DI 2.0C A 7.0CC



CATALIZZATORE UNIVERSALE PIATTO DI 2.0CC A 7.0CC



CATALIZZATORE UNIVERSALE ROTONDO FINCHÉ 2.0CC



CATALIZZATORE UNIVERSALE PIATTO DI 2.0C A 7.0CC



CATALIZZATORE UNIVERSALE PIATTO DI 2.0CC A 7.0CC



CATALIZZATORE UNIVERSALE PIATTO FINCHÉ 2.0CC



CATALIZZATORE UNIVERSALE ROTONDO FINCHÉ 2.0CC



| REF. | DESCRIZIONE | Kg | ft | € |
|-------|--|------|----|---------|
| 50905 | CATALIZZATORE DIESEL PIATTO KD3N 82527 | 1,57 | 1 | 172,00€ |
| 51548 | CATALIZZATORE UNIVERSALE PIATTO DI 2.0C A 7.0CC | 3,15 | 1 | 346,50€ |
| 51549 | CATALIZZATORE UNIVERSALE PIATTO DI 2.0CC A 7.0CC | 3,12 | 1 | 346,50€ |
| 51550 | CATALIZZATORE UNIVERSALE PIATTO DI 2.0C A 7.0CC | 3,55 | 1 | 378,50€ |
| 51551 | CATALIZZATORE UNIVERSALE PIATTO DI 2.0CC A 7.0CC | 3 | 1 | 277,50€ |
| 51555 | CATALIZZATORE UNIVERSALE PIATTO FINCHÉ 2.0CC | 2,18 | 1 | 169,50€ |
| 51556 | CATALIZZATORE UNIVERSALE ROTONDO FINCHÉ 2.0CC | 1,8 | 1 | 169,50€ |
| 51557 | CATALIZZATORE UNIVERSALE PIATTO FINCHÉ 2.0CC | 2,13 | 1 | 169,50€ |
| 51558 | CATALIZZATORE UNIVERSALE ROTONDO FINCHÉ 2.0CC | 1,84 | 1 | 169,50€ |
| 51583 | CATALIZZATORE DIESEL PIATTO STANDARD | 1,85 | 1 | 183,00€ |

PER DIESEL

PIATTO



PIATTO





CONSUMABILI

| | |
|-------------------------------|-----|
| ANELLI | 243 |
| SPINE | 243 |
| CHIAVETTE | 244 |
| VITI E DADI | 245 |
| RIVETTI | 246 |
| RONDELLE | 247 |
| FASCETTE | 251 |
| O-RINGS | 251 |
| TUBI TERMORETRATTICI. | 252 |
| INGRASSATORI | 252 |
| FUSIBILI | 254 |
| MORSETTI | 255 |
| CLIPS DI PLASTICA. | 256 |



SET DI ANELLI AD "E"

53348 0,3 6 24
9,00€ Kg ft **150 PCS**



| | | | | | | | | | |
|--|--------|--------|--------|--------|--------|--------|--------|--------|--------|
| | M1.5 | M3 | M5 | M6 | M9 | M12 | M15 | M19 | M22 |
| | 15 PCS | 15 PCS | 20 PCS | 25 PCS | 25 PCS | 20 PCS | 10 PCS | 10 PCS | 10 PCS |

SET DI MANICOTTI IN GOMMA

53349 0,25 6 24
9,00€ Kg ft **125 PCS**



| | | | | | | | | | |
|------------------|-------------------|----------------|------------------|-----------------|-----------------|-------------|--------------|-------------|-------------|
| 19,5x23 2 PCS | 16x24 3 PCS | 13x15 3 PCS | 11,5x19 4 PCS | 10x20 3 PCS | 10x12 5 PCS | 25 2 PCS | 22 3 PCS | 19 4 PCS | 15 5 PCS |
| | 9,8x11,5 6 PCS | 8x14 3 PCS | 7,5x13 7 PCS | 6x7,5 10 PCS | 3,5x6 15 PCS | | 12 10 PCS | 9 20 PCS | 7 20 PCS |

CAPPUCCIO IN PLASTICA

53370 0,3 6 12
21,50€ Kg ft **190 PCS**



| | | | | | | | |
|--|--------|--------|--------|--------|--------|--------|--------|
| | M2 | M3 | M4 | M5 | M6 | M8 | M10 |
| | 25 PCS | 25 PCS | 30 PCS | 30 PCS | 30 PCS | 20 PCS | 20 PCS |

SET DI SPINE ELASTICHE

53350 0,4 6 24
11,00€ Kg ft **120 PCS**



| | | | |
|---------------|----------------|----------------|----------------|
| 1/16x3/16 4u. | 5/64x1 4u. | 1/8x1 5u. | 3/16x5/8 5u. |
| 1/16x5/16 4u. | 3/32x5/8 4u. | 1/8x1-1/4 5u. | 3/16x1 5u. |
| 1/16x3/4 4u. | 3/32x1 4u. | 5/32x5/8 4u. | 3/16x1-1/4 5u. |
| 5/64x1/4 4u. | 3/32x1-1/4 4u. | 5/32x1 4u. | 7/32x5/8 4u. |
| 5/64x1/2 4u. | 1/8x5/8 5u. | 5/32x1-1/2 4u. | 7/32x1-1/4 4u. |
| | | | 7/32x1-3/4 4u. |
| | | | 1/4x5/8 4u. |
| | | | 1/4x1-1/4 4u. |
| | | | 1/4x1-3/4 4u. |
| | | | 5/16x3/4 4u. |
| | | | 5/16x1-1/2 4u. |
| | | | 5/16x2 4u. |
| | | | 3/8x3/4 2u. |
| | | | 3/8x1-1/2 2u. |
| | | | 3/8x2 2u. |

ASTUCCIO CON SPINOTTI

52027 1,02 5 690
15,50€ Kg ft **365 PCS**



| | | | | | |
|--|--------------------|--------------------|------------------|--------------------|--------------------|
| | 1,2x25mm 50 PCS | 1,6x32mm 50 PCS | 2x40mm 50 PCS | 2,5x40mm 50 PCS | 3,2x40mm 50 PCS |
| | 3,2x50mm 50 PCS | 4x50mm 40 PCS | 5x63mm 10 PCS | 6,3x63mm 15 PCS | |

SET DI COPIGLIE IN ACCIAIO INOX

53372 1,2 6 12
23,50€ Kg ft **144 PCS**



| | | | | | | |
|--|-----------------|-----------------|-----------------|-----------------|-----------------|----------------|
| | M3x50 50 PCS | M4x60 30 PCS | M5x75 20 PCS | M6x50 20 PCS | M6x75 16 PCS | M8x60 8 PCS |
|--|-----------------|-----------------|-----------------|-----------------|-----------------|----------------|

SET DI PERNI DI FISSAGGIO CON ANELLO

53371 1,45 6 12 **50**
22,00€ Kg **PCS**



5x36 **16** PCS
6x45 **18** PCS
8x45 **6** PCS
11x45 **10** PCS

ASTUCCIO CLIP "R"

52044
21,00€
 Kg 0,68
 6
 12
 400



150
 PCS



| REF. | MISURA | U. | €/U. |
|-------|-----------|----|-------|
| 10882 | 2,00x32mm | 42 | 0,12€ |
| 10883 | 1,60x36mm | 30 | 0,11€ |
| 10884 | 1,60x42mm | 25 | 0,12€ |
| 10793 | 2,30x43mm | 25 | 0,15€ |
| 10794 | 3,20x52mm | 20 | 0,29€ |
| 10795 | 3,80x75mm | 8 | 0,46€ |

RICAMBI DISPONIBILI

SET DI BULLONI A OCCHIELLO

53352 0,6 6 24 **151**
11,00€ Kg **PCS**



2,4x25 **60** PCS
4x45 **12** PCS
4x50 **12** PCS

2,4x41 **50** PCS
4x64 **12** PCS
4,2x85 **5** PCS

SET DI PERNI CON FORO PER COPIGLIA

53363 1,15 6 24 **71**
22,00€ Kg **PCS**



8x50 **5** PCS
9.5x50 **18** PCS
11x63 **5** PCS
12.5x50 **3** PCS

3.5x44 **6** PCS
2.5x42 **20** PCS
2.5x58 **7** PCS
2x3 **7** PCS

SET DI CHIAVETTE

53364 0,8 6 24 **106**
11,00€ Kg **PCS**



3x3x25 **4** PCS
3x3x20 **4** PCS
5x5x30 **5** PCS
5x5x25 **5** PCS
5x5x20 **5** PCS
6x6x40 **5** PCS
6x6x30 **5** PCS
6x6x20 **5** PCS
8x8x40 **5** PCS
8x8x30 **5** PCS
10x10x40 **5** PCS
10x10x30 **5** PCS
12x12x40 **2** PCS

SET DI VITI METRICHE CON TESTA ESAGONALE

53351 0,9 6 12 **240**
11,00€ Kg **PCS**



4x12 **10** PCS
4x20 **10** PCS
5x16 **10** PCS
5x25 **10** PCS
6x20 **10** PCS
6x30 **10** PCS
8x25 **5** PCS
8x40 **5** PCS
4 **20** PCS
5 **20** PCS
6 **20** PCS
8 **10** PCS
10 **10** PCS
4 **20** PCS
5 **20** PCS
6 **20** PCS
8 **10** PCS
10 **10** PCS

SET DI VITI AUTOFORANTI

| | | | | | |
|---------------|------|---|----|-------------------|--|
| 53354 | 0,55 | 6 | 24 | 200 PCS | |
| 11,00€ | Kg | | | | |



| | | | | | | | |
|---------|--------|--------|--------|----------|--------|--------|--------|
| #8x12.5 | #8x16 | #8x19 | #8x25 | #10x12.5 | #10x16 | #10x19 | #10x25 |
| 30 PCS | 30 PCS | 30 PCS | 30 PCS | 20 PCS | 20 PCS | 20 PCS | 20 PCS |

SET DI VITI CON TESTA AD INCAVO ESAGONALE

| | | | | | |
|---------------|------|---|----|-------------------|--|
| 53362 | 0,65 | 6 | 24 | 106 PCS | |
| 10,00€ | Kg | | | | |



| | | | | | | | | |
|--------|--------|--------|-------|--------|-------|-------|--------|-------|
| 4x12 | 5x12 | 5x25 | 10x40 | 6x25 | 8x40 | 10x25 | 6x12 | 8x25 |
| 25 PCS | 25 PCS | 20 PCS | 3 PCS | 10 PCS | 5 PCS | 3 PCS | 10 PCS | 5 PCS |

SET DI STAFFE A "U"

| | | | | | |
|---------------|------|---|----|-------------------|--|
| 53366 | 0,35 | 6 | 24 | 170 PCS | |
| 10,00€ | Kg | | | | |



| | | | | |
|---------|---------|--------|--------|--------|
| #6x5/16 | #8x5/8 | #6 | #6 | #8 |
| 40 PCS | 20 PCS | 20 PCS | 20 PCS | 20 PCS |
| #10x1/2 | 1/4x3/4 | 1/4 | #10 | |
| 15 PCS | 10 PCS | 10 PCS | 15 PCS | |

SET DI VITI AUTOFILETTANTI A TESTA SVASATA

| | | | | | |
|---------------|------|---|----|-------------------|--|
| 53369 | 0,65 | 6 | 24 | 550 PCS | |
| 11,50€ | Kg | | | | |



| | | | | | | |
|--------|--------|----------|---------|--------|-----------|--------|
| 4x1/2" | 4x5/8" | 6x3/8" | 6x1/2" | 6x5/8" | 6x3/4" | 8x1/2" |
| 65 PCS | 55 PCS | 60 PCS | 65 PCS | 60 PCS | 45 PCS | 50 PCS |
| 8x5/8" | 8x1" | 8x1-1/4" | 10x3/4" | 10x1" | 10x1-1/4" | |
| 40 PCS | 30 PCS | 20 PCS | 25 PCS | 20 PCS | 15 PCS | |

ASTUCIO CON DADI AUTOBLOCCAGGIO

| | | | | |
|---------------|------|---|-----|-------------------|
| 52029 | 1,02 | 5 | 360 | 228 PCS |
| 15,50€ | Kg | | | |



| | | | | |
|--------|--------|--------|--------|--------|
| M3 | M4 | M5 | M6 | M8 |
| 50 PCS | 50 PCS | 40 PCS | 30 PCS | 20 PCS |
| M10 | M12 | M14 | M16 | |
| 15 PCS | 10 PCS | 8 PCS | 5 PCS | |

ASTUCIO CON DADI

| | | | | |
|---------------|------|---|-----|-------------------|
| 52028 | 1,05 | 5 | 360 | 243 PCS |
| 11,00€ | Kg | | | |



| REF. | MISURA | U. | €/U. | REF. | MISURA | U. | €/U. |
|-------|--------|----|-------|-------|--------|----|-------|
| 10805 | M3 | 50 | 0,06€ | 10785 | M10 | 20 | 0,06€ |
| 10779 | M4 | 50 | 0,50€ | 10786 | M12 | 10 | 0,11€ |
| 10780 | M5 | 50 | 0,50€ | 10812 | M14 | 8 | 0,22€ |
| 10781 | M6 | 30 | 0,50€ | 10813 | M16 | 5 | 0,28€ |
| 10784 | M8 | 20 | 0,50€ | | | | |

RICAMBI DISPONIBILI

SET DI DADI METRICI AD ALETTE

| | | | | | | |
|--------------|------|---|----|------------|--|--|
| 53365 | 0,75 | 6 | 24 | 150 PCS | | |
| 12,50€ | Kg | | | | | |



| | | | | | |
|--|------------------------|------------------------|------------------------|------------------------|-------------------------|
| | M4 40 PCS | M5 40 PCS | M6 25 PCS | M8 25 PCS | M10 20 PCS |
|--|------------------------|------------------------|------------------------|------------------------|-------------------------|

SET DI DADI A RIVETTO CON ZIGRINATURA IN ALLUMINIO

| | | | | | | |
|--------------|-----|---|----|------------|--|--|
| 53361 | 0,2 | 6 | 24 | 150 PCS | | |
| 17,50€ | Kg | | | | | |



| | | | | | |
|-------------------------|--------------------------|--------------------------|--------------------------|--------------------------|---------------------------|
| 3x9 40 PCS | 4x11 35 PCS | 5x13 25 PCS | 6x15 25 PCS | 8x18 15 PCS | 10x21 10 PCS |
|-------------------------|--------------------------|--------------------------|--------------------------|--------------------------|---------------------------|

SET DADO A RIVETTO

| | | | | | | |
|--------------|------|---|----|-----|------------|--|
| 52703 | 0,79 | 5 | 20 | 800 | 235 PCS | |
| 14,50€ | Kg | | | | | |



| | | | | | | |
|------------------------|------------------------|------------------------|------------------------|------------------------|-------------------------|-------------------------|
| M3 50 PCS | M4 50 PCS | M5 50 PCS | M6 40 PCS | M8 20 PCS | M10 15 PCS | M12 10 PCS |
|------------------------|------------------------|------------------------|------------------------|------------------------|-------------------------|-------------------------|

SET DI DADI A RIVETTO CON ZIGRINATURA IN ZINCO

| | | | | | | |
|--------------|------|---|----|------------|--|--|
| 53360 | 0,45 | 6 | 24 | 150 PCS | | |
| 13,00€ | Kg | | | | | |



| | | | | | |
|-------------------------|--------------------------|--------------------------|--------------------------|--------------------------|---------------------------|
| 3x9 40 PCS | 4x11 35 PCS | 5x13 25 PCS | 6x15 25 PCS | 8x18 15 PCS | 10x21 10 PCS |
|-------------------------|--------------------------|--------------------------|--------------------------|--------------------------|---------------------------|

➤ RICAMBI DISPONIBILI

ASTUCCIO DI RIVETTI

| | | | | | | |
|--------------|------|---|----|-----|------------|--|
| 52043 | 0,98 | 6 | 12 | 480 | 300 PCS | |
| 19,00€ | Kg | | | | | |



| REF. | MISURA | | €/U. |
|-------|-------------|----|-------|
| 10877 | 4,8x16,90mm | 5 | 0,13€ |
| 10878 | 4,8x24,80mm | 10 | 0,17€ |
| 10879 | 3,2x9,70mm | 10 | 0,10€ |
| 10880 | 4,8x12,70mm | 10 | 0,12€ |
| 10881 | 4,8x20,00mm | 10 | 0,14€ |

➤ RICAMBI DISPONIBILI

ASTUCCIO DI RIVETTI PLASTICI

| | | | | |
|---------------|------|----|-----|-------------------|
| 52711 | 0,44 | 48 | 384 | 150 PCS |
| 23,50€ | Kg | | | |



| | | | |
|--|------------------------------|------------------------------|------------------------------|
| | 6x19.3mm 25 PCS | 6x17.9mm 25 PCS | 6x25.5mm 25 PCS |
| | 6x24.5mm 25 PCS | 6x24mm 25 PCS | 6x24mm 25 PCS |

RIVETTATRICE DISPONIBILI IN PAG. 44 (REF. 52575)

SET DI CHIODI

| | | | | |
|---------------|------|---|----|--------------------|
| 53379 | 0,55 | 6 | 24 | 1000 PCS |
| 12,50€ | Kg | | | |



| | | | | | | | | | | | |
|--|--------------------------|--|--------------------------|--|-------------------------------|--|----------------------------|--|------------------------------|--|-----------------------------|
| | 60 PCS | | 40 PCS | | 1.5x12mm 150 PCS | | 2.4x30 35 PCS | | 2.5x30 30 PCS | | 2.5x40 25 PCS |
| | 5/8" 60 PCS | | 3/4" 40 PCS | | 2x30mm 55 PCS | | 10mm 45 PCS | | 1.20x20 220 PCS | | 1.4x25 120 PCS |
| | | | | | | | | | 2x38 40 PCS | | 1.6x30 80 PCS |

ASTUCCIO CON ASSORTIMENTO DI BULLONI, DADI E RONDELLE

| | | | | |
|---------------|------|---|-----|-------------------|
| 51804 | 5,68 | 5 | 120 | 828 PCS |
| 52,00€ | Kg | | | |



| REF. | CARATTERISTICHE | | U. | €/U. |
|-------|---------------------------------|------|----|-------|
| 10772 | Vite zincata DIN 933 8.8 M4x25 | 0,01 | 25 | 0,02€ |
| 10773 | Vite zincata DIN 933 8.8 M5x50 | 0,01 | 25 | 0,06€ |
| 10774 | Vite zincata DIN 933 8.8 M6x50 | 0,01 | 25 | 0,09€ |
| 10775 | Vite zincata DIN 933 8.8 M7x50 | 0,01 | 15 | 0,13€ |
| 10776 | Vite zincata DIN 933 8.8 M8x50 | 0,01 | 15 | 0,18€ |
| 10777 | Vite zincata DIN 933 8.8 M10x50 | 0,04 | 12 | 0,21€ |
| 10778 | Vite zincata DIN 933 8.8 M12x60 | 0,05 | 20 | 0,35€ |
| 10779 | Dado zincato DIN 934 m4 | 0,02 | 50 | 0,50€ |
| 10780 | Dado zincato DIN 934 m5 | 0,01 | 50 | 0,50€ |
| 10781 | Dado zincato DIN 934 m6 | 0,01 | 50 | 0,02€ |
| 10782 | Dado zincato DIN 934 m7 | 0,01 | 50 | 0,02€ |

RICAMBI DISPONIBILI

| REF. | CARATTERISTICHE | | U. | €/U. |
|-------|-------------------------------|------|----|--------|
| 10784 | Dado zincato DIN 934 m8 | 0,01 | 50 | 0,02€ |
| 10785 | Dado zincato DIN 934 m10 | 0,01 | 50 | 0,06€ |
| 10786 | Dado zincato DIN 934 m12 | 0,01 | 40 | 0,11€ |
| 10787 | Rondella zincata DIN 125 m4 | 0,01 | 50 | 0,50€ |
| 10788 | Rondella zincata DIN 125 m5 | 0,01 | 50 | 0,50€ |
| 10789 | Rondella zincata DIN 125 m6 | 0,01 | 50 | 0,50€ |
| 10790 | Rondella zincata DIN 125 m7 | 0,01 | 50 | 0,02€ |
| 10791 | Rondella zincata DIN 125 m8 | 0,01 | 50 | 0,03€ |
| 10792 | Rondella zincata DIN 125 m10 | 0,01 | 50 | 0,04€ |
| 10783 | Rondella zincata DIN 125 m12 | 0,01 | 50 | 0,04€ |
| 50959 | Organizer a 19 scompartimenti | 0,7 | 1 | 12,50€ |





ASTUCCIO DI RONDELLE DI FERRO GALVANIZZATO 475 PEZZI

| | | | | |
|---------------|------|---|----|-------------------|
| 52158 | 3,45 | 5 | 90 | 475 PCS |
| 37,50€ | Kg | | | |



| | | | |
|---------------------------------|---------------------------------|--------------------------------|--------------------------------|
| 5x20x1,5mm 50 PCS | 6x20x1,5mm 50 PCS | 7x20x1,5mm 50 PCS | 8x20x1,5mm 50 PCS |
| 8x20x1,75mm 50 PCS | 10x30x2,5mm 25 PCS | 6x30x2mm 25 PCS | 7x30x2mm 25 PCS |
| 8x30x2mm 25 PCS | 4x11x0,98mm 50 PCS | 14x40x3mm 25 PCS | 4x20x1,5mm 50 PCS |





SET DI RONDELLE

53377 1,6 6 12 **240** 
18,00€ Kg   



| | | | | | |
|-----------------------|-----------------------|------------------------|-----------------------|------------------------|------------------------|
| 20x6x1.5 20 PCS | 20x8x1.5 20 PCS | 20x10x1.5 20 PCS | 25x6x1.5 20 PCS | 25x8x1.5 20 PCS | 25x10x1.5 20 PCS |
| 32x2x1.5 20 PCS | 32x4x1.5 20 PCS | 32x6x1.5 20 PCS | 32x8x1.5 20 PCS | 32x10x1.5 20 PCS | 32x10x1.5 20 PCS |



ASTUCCIO DI RONDELLE D'ALLUMINIO 18 TIPI

52031 0,57 24 384 **900** 
44,00€ Kg   



| | | | | | |
|-------------------------|--------------------------|--------------------------|--------------------------|--------------------------|--------------------------|
| 3x7x1,5mm 50 PCS | 4x8x1,5mm 50 PCS | 5x6x1,5mm 50 PCS | 16x22x1,5mm 50 PCS | 14x22x1,5mm 50 PCS | 14x20x1,5mm 50 PCS |
| 6x10x1,5mm 50 PCS | 6x11x1,5mm 50 PCS | 7x11x1,5mm 50 PCS | 7x12x1,5mm 50 PCS | 8x12x1,5mm 50 PCS | 8x14x1,5mm 50 PCS |
| 9x12x1,5mm 50 PCS | 10x14x1,5mm 50 PCS | 11x16x1,5mm 50 PCS | 11x17x1,5mm 50 PCS | 12x16x1,5mm 50 PCS | 12x16x1,5mm 50 PCS |

ORGANIZER DI RONDELLE DI RAME NERO

52032
29,50€
 Kg 1,68
 5
 870
1.735
 PCS



| | | | | | |
|---|-------------------|-------------------|-------------------|-------------------|-------------------|
|  | 3mm 600 PCS | 4mm 400 PCS | 5mm 220 PCS | 6mm 220 PCS | 8mm 110 PCS |
| | 10mm 65 PCS | 12mm 50 PCS | 14mm 40 PCS | 16mm 30 PCS | |





ASTUCCIO DI RONDELLE DI RAME PER INIETTORI

53229 0,4 5 20 **150** 
31,00€ Kg   

















| | | | | |
|-----------------------------|-----------------------------|-----------------------------|-----------------------------|-----------------------------|
| 13.8x7.3x1.4mm 10 PCS | 15.0x7.0x2.0mm 10 PCS | 15.0x7.5x2.5mm 10 PCS | 16.0x7.5x1.7mm 10 PCS | 16.0x7.5x2.0mm 10 PCS |
| 14.6x7.5x1.3mm 10 PCS | 15.0x7.5x1.0mm 10 PCS | 15.0x7.5x2.0mm 10 PCS | 15.0x7.5x3.0mm 10 PCS | 16.0x7.5x1.5mm 10 PCS |
| 14.6x7.5x3.0mm 10 PCS | 15.0x7.5x1.5mm 10 PCS | 15.5x7.5x2.0mm 10 PCS | 16.4x7.5x2.0mm 10 PCS | 20.0x9.4x0.9mm 10 PCS |

ASTUCCIO DI RONDELLE DI RAME PER INIETTORI

53340 0,9 10 1.050 **375** 
74,50€ Kg   



| | | |
|--|--|--|
|  13819 6,00€ 50 13.8 x 7.3 x 1.4 mm |  13824 7,50€ 50 15.0 x 7.5 x 1.5 mm |  13829 9,00€ 50 16.0 x 7.5 x 1.5 mm |
|  13820 6,50€ 50 14.6 x 7.5 x 1.3 mm |  13825 9,50€ 50 15.0 x 7.5 x 2.0 mm |  13830 10,00€ 50 16.0 x 7.5 x 1.7 mm |
|  13821 12,50€ 50 14.6 x 7.5 x 3.0 mm |  13826 12,00€ 50 15.0 x 7.5 x 2.5 mm |  13831 11,50€ 50 16.0 x 7.5 x 2.0 mm |
|  13822 10,00€ 50 15.0 x 7.0 x 2.0 mm |  13827 14,50€ 50 15.0 x 7.5 x 3.0 mm |  13832 12,00€ 50 16.4 x 7.5 x 2.0 mm |
|  13823 5,00€ 50 15.0 x 7.5 x 1.0 mm |  13828 10,50€ 50 15.5 x 7.5 x 2.0 mm |  13833 8,00€ 50 20.0 x 9.4 x 0.9 mm |

ASTUCCIO DI RONDELLE DI RAMA PER INIETTORI 551 PZ.



| | | | | |
|----------------|-----|---|----|-------------------|
| 53464 | 1,7 | 5 | 90 | 551 PCS |
| 117,00€ | | | | |



RICAMBI DISPONIBILI

| | | |
|--|--|--|
| UNIVERSAL Ø15.0x8.0x1.5 13945 6,00€ | MERCEDES Ø15.0x7.0x1.5 13946 8,00€ | RENAULT Ø13.0x7.5x2.5 13947 7,50€ |
| IVECO, FORD, BMW, MAN Ø15.0x7.5x1.5 13948 6,50€ | UNIVERSAL Ø15.45x8.0x2.0 13949 8,50€ | UNIVERSAL Ø15.45x8.0x2.0 13950 9,50€ |
| MAZDA Ø13.5x10x2.0 13951 6,50€ | FORD Ø15.5x7.5x2.5 13952 11,00€ | LAND ROVER Ø15.5x7.5x1.5 13953 9,00€ |
| RENAULT Ø15.0x7.5x3.0 13954 11,00€ | DEUTZ Ø13.0x7.0x1.5 13955 6,50€ | FORD Ø13.5x7.5x1.5 13956 5,50€ |
| FIAT Ø15.0x7.5x1.5 13957 8,50€ | MAN ROVER Ø15.5x7.5x1 13958 6,50€ | MERCEDES Ø16.5x7.5x2 13959 11,00€ |
| KIA Ø13.7x7.3x3 13960 5,00€ | KIA Ø13.7x7.3x2 13961 11,00€ | ACCIAIO Ø10x6.0x1.0 13962 2,50€ |
| OTTONE Ø15.8x7.5x3.0 13963 15,00€ | CONNETTORI TUBO IN "T" 13964 16,50€ | ALLUMINIO Ø8x5.8x1 13965 2,00€ |
| CONNETTORI TUBO IN "L" 13966 17,00€ | RITEGNO SPRINGS 13967 6,50€ | |

RONDELLA METALLO-PLASTICA



| | | |
|---|---|---|
| Ø 10mm / 0,02kg 52719 0,21€/u. | GOMMA (Ford) Ø 13mm / 0,01kg 51554 0,31€/u. | Ø 16mm / 0,01kg 51799 0,21€/u. |
| Ø 12mm / 0,03kg 51843 0,21€/u. | Ø 14mm / 0,01kg 51546 0,21€/u. | |

ASTUCCIO RONDELLE DI RAME

| | | | | | |
|---------------|------|---|----|-----|-------------------|
| 52163 | 0,65 | 5 | 20 | 400 | 525 PCS |
| 64,00€ | | | | | |



| REF. | MISURA | U. |
|-------|---------|-----|
| 51538 | Ø 10mm | 100 |
| 51539 | Ø 12 mm | 100 |
| 51540 | Ø 14 mm | 100 |
| 51541 | Ø 16 mm | 100 |
| 51542 | Ø 18 mm | 100 |
| 51543 | Ø 20 mm | 25 |

COMPRESSIBILE



RONDELLA DI RAME



| REF. | Gr. | | | €/U. |
|-------|-----------------|------|-----|----------|
| 51538 | Ø 10mm / 0,01kg | 0,01 | 100 | 0,10€/u. |
| 51539 | Ø 12mm / 0,01kg | 0,01 | 100 | 0,12€/u. |
| 51540 | Ø 14mm / 0,01kg | 0,01 | 100 | 0,13€/u. |
| 51541 | Ø 16mm / 0,01kg | 0,01 | 100 | 0,13€/u. |
| 51542 | Ø 18mm / 0,01kg | 0,01 | 100 | 0,15€/u. |
| 51543 | Ø 20mm / 0,01kg | 0,01 | 100 | 0,18€/u. |
| 51544 | Ø 22mm / 0,02kg | 0,01 | 100 | 0,21€/u. |
| 51545 | Ø 26mm / 0,02kg | 0,01 | 100 | 0,29€/u. |

ASTUCCIO DI RONDELLE DI RAME 18 TIPI



RICAMBI DISPONIBILI

| | | | | | |
|---------------|------|---|----|-----|-------------------|
| 52030 | 1,21 | 4 | 12 | 384 | 900 PCS |
| 69,50€ | Kg | | | | |



| REF. | MISURA | €/U. | REF. | MISURA | €/U. |
|-------|-------------|-------|-------|-------------|-------|
| 10823 | 3x7x1,5mm | 0,10€ | 10832 | 7x12x1,5mm | 0,10€ |
| 10824 | 4x8x1,5mm | 0,10€ | 10833 | 8x12x1,5mm | 0,10€ |
| 10825 | 5x6x1,5mm | 0,10€ | 10834 | 8x14x1,5mm | 0,13€ |
| 10826 | 16x22x1,5mm | 0,21€ | 10835 | 9x12x1,5mm | 0,13€ |
| 10827 | 14x22x1,5mm | 0,25€ | 10836 | 10x14x1,5mm | 0,18€ |
| 10828 | 14x20x1,5mm | 0,25€ | 10837 | 11x16x1,5mm | 0,18€ |
| 10829 | 6x10x1,5mm | 0,10€ | 10838 | 11x17x1,5mm | 0,18€ |
| 10830 | 6x11x1,5mm | 0,10€ | 10839 | 12x16x1,5mm | 0,21€ |
| 10831 | 7x11x1,5mm | 0,10€ | 10840 | 12x18x1,5mm | 0,13€ |

SET DI RONDELLE IN RAME

| | | | | |
|---------------|-----|---|----|-------------------|
| 53353 | 0,2 | 6 | 24 | 110 PCS |
| 14,50€ | Kg | | | |



| | | | | | | |
|--|------------------|------------------|------------------|------------------|------------------|------------------|
| | M6 | M8 | M10 | M12 | M14 | M16 |
| | 30 PCS | 25 PCS | 20 PCS | 15 PCS | 10 PCS | 10 PCS |

SET DI RONDELLE ONDULATE

| | | | | |
|---------------|------|---|----|-------------------|
| 53373 | 0,25 | 6 | 24 | 260 PCS |
| 12,50€ | Kg | | | |



| | | | | | | | |
|--|------------------|------------------|------------------|------------------|------------------|------------------|------------------|
| | M3x10 | M4x12 | M5x14 | M6x14 | M8x18 | M10x20 | M12x25 |
| | 30 PCS | 30 PCS | 40 PCS | 50 PCS | 50 PCS | 40 PCS | 20 PCS |

ANELLO ELASTICO ESTERNO

| | | | | |
|--------------|-----|---|----|-------------------|
| 53383 | 0,2 | 6 | 24 | 300 PCS |
| 8,00€ | Kg | | | |



| | | | | | |
|--|------------------|------------------|------------------|------------------|------------------|
| | M4 | M6 | M8 | M10 | M12 |
| | 50 PCS | 40 PCS | 45 PCS | 30 PCS | 30 PCS |
| | M14 | M16 | M18 | M20 | M22 |
| | 25 PCS | 25 PCS | 25 PCS | 15 PCS | 15 PCS |

ANELLO ELASTICO INTERNO

| | | | | |
|--------------|------|---|----|-------------------|
| 53382 | 0,15 | 6 | 24 | 300 PCS |
| 8,00€ | Kg | | | |



| | | | | | |
|--|------------------|------------------|------------------|------------------|------------------|
| | M4 | M6 | M8 | M10 | M12 |
| | 50 PCS | 40 PCS | 45 PCS | 30 PCS | 30 PCS |
| | M14 | M16 | M18 | M20 | M22 |
| | 25 PCS | 25 PCS | 25 PCS | 15 PCS | 15 PCS |

SET DI RONDELLE IN FIBRA

| | | | | |
|---------------|------|---|----|-------------------|
| 53381 | 0,25 | 6 | 12 | 600 PCS |
| 11,00€ | | | | |
| Kg | | | | |



| | | | | |
|--|-------------------|------------------|--------------------|------------------|
| | 10x5.5x1 | 16x10x1 | 19x12x1 | 22x16x1 |
| | 160 PCS | 80 PCS | 40 PCS | 30 PCS |
| | 22.5x14x1 | 32x22x1 | 12x6.5x1 | 16x8x1 |
| | 20 PCS | 20 PCS | 100 PCS | 60 PCS |
| | 20x12.5x1 | 27x20x1 | 25.4x17.5x1 | 32x24x1 |
| | 40 PCS | 20 PCS | 15 PCS | 15 PCS |

SET DI FASCETTE PER TUBO FLESSIBILE

53378
11,00€

0,45 Kg 6 24

20 PCS



| | | | | | | | |
|--------|-------|--------|-------|--------|-------|----|-------|
| 1" | 4 PCS | 1-1/4" | 2 PCS | 1-3/4" | 2 PCS | 2" | 4 PCS |
| 2-1/2" | 2 PCS | 3" | 2 PCS | 3-1/2" | 2 PCS | 4" | 2 PCS |



ORGANIZER DI O-RING

METRICI - 386 UNITÀ

| | | | | | | | |
|-----------------------|----------------------------|-----|-----|-----|-----|-----|-----|
| COPERCIO DEL ASTUCCIO | Posizione del astuccio | 006 | 007 | 008 | 009 | 010 | 011 |
| | Larghezza della gomma (mm) | 2 | 2 | 2 | 2 | 2 | 2 |
| | Ø Interni (mm) | 3 | 4 | 5 | 6 | 7 | 8 |
| | Quantità | 16 | 16 | 16 | 16 | 16 | 16 |

| | | | | | | |
|-----------------------|----------------------------|-----|-----|-----|-----|-----|
| COPERCIO DEL ASTUCCIO | Posizione del astuccio | 113 | 112 | 111 | 110 | 012 |
| | Larghezza della gomma (mm) | 2.5 | 2.5 | 2.5 | 2.5 | 2 |
| | Ø Interni (mm) | 14 | 12 | 11 | 10 | 10 |
| | Quantità | 13 | 13 | 13 | 13 | 17 |

| | | | | | |
|-----------------------|----------------------------|-----|-----|-----|-----|
| COPERCIO DEL ASTUCCIO | Posizione del astuccio | 114 | 115 | 116 | 210 |
| | Larghezza della gomma (mm) | 2.5 | 2.5 | 2.5 | 3 |
| | Ø Interni (mm) | 16 | 17 | 19 | 19 |
| | Quantità | 13 | 13 | 13 | 10 |

| | | | | | |
|-------------------|----------------------------|-----|-----|-----|-----|
| BASE DEL ASTUCCIO | Posizione del astuccio | 222 | 325 | 326 | 327 |
| | Larghezza della gomma (mm) | 3 | 4 | 4 | 4 |
| | Ø Interni (mm) | 38 | 38 | 41 | 44 |
| | Quantità | 12 | 10 | 9 | 9 |

| | | | | | | |
|-------------------|----------------------------|-----|-----|-----|-----|-----|
| BASE DEL ASTUCCIO | Posizione del astuccio | 221 | 220 | 219 | 218 | 217 |
| | Larghezza della gomma (mm) | 3 | 3 | 3 | 3 | 3 |
| | Ø Interni (mm) | 36 | 35 | 33 | 32 | 30 |
| | Quantità | 12 | 12 | 12 | 12 | 12 |

| | | | | | | | |
|-------------------|----------------------------|-----|-----|-----|-----|-----|-----|
| BASE DEL ASTUCCIO | Posizione del astuccio | 211 | 212 | 213 | 214 | 215 | 216 |
| | Larghezza della gomma (mm) | 3 | 3 | 3 | 3 | 3 | 3 |
| | Ø Interni (mm) | 20 | 22 | 24 | 25 | 27 | 28 |
| | Quantità | 12 | 12 | 12 | 12 | 12 | 12 |

POLLICI - 386 UNITÀ

| | | | | | | | |
|-----------------------|------------------------|------|------|------|------|------|------|
| COPERCIO DEL ASTUCCIO | Posizione del astuccio | 006 | 007 | 008 | 009 | 010 | 011 |
| | Larghezza della gomma | 1/16 | 1/16 | 1/16 | 1/16 | 1/16 | 1/16 |
| | Ø Interni | 1/8 | 5/32 | 3/16 | 7/32 | 1/4 | 5/16 |
| | Quantità | 20 | 20 | 20 | 20 | 20 | 20 |

| | | | | | | |
|-----------------------|------------------------|------|------|------|------|------|
| COPERCIO DEL ASTUCCIO | Posizione del astuccio | 113 | 112 | 111 | 110 | 012 |
| | Larghezza della gomma | 3/32 | 3/32 | 3/32 | 3/32 | 1/16 |
| | Ø Interni | 9/16 | 1/2 | 7/16 | 3/8 | 3/8 |
| | Quantità | 13 | 13 | 13 | 13 | 13 |

| | | | | | |
|-----------------------|------------------------|------|-------|------|-----|
| COPERCIO DEL ASTUCCIO | Posizione del astuccio | 114 | 115 | 116 | 210 |
| | Larghezza della gomma | 3/32 | 3/32 | 3/32 | 1/8 |
| | Ø Interni | 5/8 | 11/16 | 3/4 | 3/4 |
| | Quantità | 13 | 13 | 13 | 10 |

| | | | | | |
|-------------------|------------------------|------|------|------|------|
| BASE DEL ASTUCCIO | Posizione del astuccio | 222 | 325 | 326 | 327 |
| | Larghezza della gomma | 1/8 | 3/16 | 3/16 | 3/16 |
| | Ø Interni | 11/2 | 11/2 | 15/8 | 13/4 |
| | Quantità | 10 | 7 | 7 | 7 |

| | | | | | | |
|-------------------|------------------------|-------|------|-------|------|-------|
| BASE DEL ASTUCCIO | Posizione del astuccio | 221 | 220 | 219 | 218 | 217 |
| | Larghezza della gomma | 1/8 | 1/8 | 1/8 | 1/8 | 1/8 |
| | Ø Interni | 17/16 | 13/8 | 15/16 | 11/4 | 13/16 |
| | Quantità | 10 | 10 | 10 | 10 | 10 |

| | | | | | | | |
|-------------------|------------------------|-------|-----|-------|-----|-------|------|
| BASE DEL ASTUCCIO | Posizione del astuccio | 211 | 212 | 213 | 214 | 215 | 216 |
| | Larghezza della gomma | 1/8 | 1/8 | 1/8 | 1/8 | 1/8 | 1/8 |
| | Ø Interni | 13/16 | 7/8 | 15/16 | 1 | 11/16 | 11/8 |
| | Quantità | 10 | 10 | 10 | 10 | 10 | 10 |

50651
15,50€

0,58 Kg

5

20

400



QUALITÀ HNBR

50652
15,50€

0,66 Kg

5

20

400



QUALITÀ HNBR

ORGANIZER DI O-RING PER ARIA CONDIZIONATA

50807
33,50€

0,16 Kg

5

50

750

270 PCS



| | | | | |
|-----------------------|------------------------|------------------------|------------------------|-----------------------|
| 5.29x1.78mm 20 PCS | 6.07x1.78mm 20 PCS | 6.8x1.9mm 20 PCS | 7.65x1.78mm 20 PCS | 7.80x1.90mm 20 PCS |
| 8.0x2.0mm 20 PCS | 8.80x1.90mm 20 PCS | 10.82x1.78mm 15 PCS | 10.77x2.62mm 15 PCS | 11.0x2.0mm 15 PCS |
| 12.0x2.0mm 15 PCS | 13.9x1.80mm 10 PCS | 13.95x2.62mm 10 PCS | 14.0x2.0mm 10 PCS | 15.0x2.0mm 10 PCS |
| 17.0x2.00mm 10 PCS | 17.17x1.78mm 10 PCS | 17.04x3.53mm 10 PCS | | |

SET DI TUBI DI RISCALDAMENTO

53374 0,15 6 24
8,00€ Kg **127 PCS**



| | |
|---------|--------|
| M2x40 | 30 PCS |
| M2.5x40 | 25 PCS |
| M3.5x40 | 20 PCS |
| M5x40 | 20 PCS |
| M7x80 | 16 PCS |
| M10x80 | 8 PCS |
| M13x85 | 8 PCS |

53376 0,15 6 24
8,50€ Kg **127 PCS**



CANNELLO A GAS

51920 **20,00€**

PAG. 217



KIT DI 65 RACCORDI PER VUOTO PER AUTO

53434
14,50€

Kg 0,15
 6
 24

65 PCS



| | | | |
|-----------------------------|------------------------------|--------------------------------|------------------------------|
| 4x28.7 10 PCS | 3.9x30.8 5 PCS | 10.4x44.4 10 PCS | 5.6x47.1 5 PCS |
| 7.9x38 10 PCS | 4.7x38.9 5 PCS | 5.2x33.9 10 PCS | 7x30 10 PCS |

ASTUCCIO D'INGRASSATORE

52033 0,89 5 20 720
30,00€ Kg **135 PCS**



ANGOLO DIRITO

| REF. | MISURA | U. | €/U. |
|-------|--------|----|-------|
| 10868 | 6x1 | 20 | 0,17€ |
| 10869 | 8x1 | 15 | 0,22€ |
| 10870 | 10x1 | 10 | 0,28€ |

ANGOLO 45°

| REF. | MISURA | U. | €/U. |
|-------|--------|----|-------|
| 10871 | 6x1 | 20 | 0,22€ |
| 10872 | 8x1 | 15 | 0,39€ |
| 10873 | 10x1 | 10 | 0,39€ |

ANGOLO 90°

| REF. | MISURA | U. | €/U. |
|-------|--------|----|-------|
| 10874 | 6x1 | 20 | 0,22€ |
| 10875 | 8x1 | 15 | 0,39€ |
| 10876 | 10x1 | 10 | 0,39€ |

SET DI INGRASSATORI CON FILETTATURA METRICA

53359 0,5 6 24
13,00€ Kg **110 PCS**



| | | |
|-----------------------------|----------------------------|----------------------------|
| 6x1 60 PCS | 6x1 5 PCS | 6x1 5 PCS |
| 8x1.25 10 PCS | 8x1.25 5 PCS | 8x1.25 5 PCS |
| 10x1.5 10 PCS | 10x1.5 5 PCS | 10x1.5 5 PCS |

ANGOLO DIRITO ANGOLO 45° ANGOLO 90°

SET DI MOLLE

| | | | |
|---------------|------|---|----|
| 53358 | 0,25 | 6 | 24 |
| 10,00€ | Kg | | |

200
PCS



| | | |
|--|------------|------------------|
| | 5/16x1-3/4 | 12 PCS |
|--|------------|------------------|

| | | | | | | | | |
|---------|-----------------|------------------|------------------|------------------|-----------------|------------------|------------------|------------------|
| | 9/32x1/2 | 10 PCS | 1/4x13/32 | 10 PCS | 7/32x11/16 | 10 PCS | 7/32x1-1/2 | 10 PCS |
| 3/8x5/8 | 6 PCS | 3/8x3/4 | 12 PCS | 23/64x1-3/8 | 8 PCS | 9/32x3/4 | 10 PCS | |

| | | | | | | | | | | | |
|------------|-----------------|------------------|------------------|------------------|------------------|------------------|------------------|-----------------|------------------|------------------|------------------|
| | 13/64x13/16 | 10 PCS | 7/32x1 | 10 PCS | 1/4x7/8 | 10 PCS | 5/16x1-1/8 | 8 PCS | 5/16x1-1/4 | 10 PCS | |
| 3/16x1-3/4 | 8 PCS | 9/32x1-1/2 | 10 PCS | 11/32x1-7/16 | 10 PCS | 11/32x1-27/32 | 12 PCS | 9/32x2 | 12 PCS | 5/32x3-1/8 | 12 PCS |

LUCCHETTI

| | | | |
|--------------|-----|---|----|
| 53403 | 0,1 | 8 | 96 |
| 6,00€ | Kg | | |

38mm

| | | | |
|--------------|-----|---|----|
| 53405 | 0,1 | 8 | 96 |
| 4,50€ | Kg | | |

32mm

| | | | |
|--------------|-----|---|----|
| 53406 | 0,3 | 8 | 48 |
| 7,50€ | Kg | | |

50mm

| | | | |
|---------------|-----|---|----|
| 53407 | 0,5 | 8 | 48 |
| 11,00€ | Kg | | |

63mm

| | | | | |
|---------------|-----|---|----|-----|
| 53408 | 0,8 | 3 | 24 | 840 |
| 17,00€ | Kg | | | |

75mm



LUNGO

| | | | |
|--------------|-----|---|----|
| 53404 | 0,2 | 8 | 96 |
| 6,00€ | Kg | | |

38mm

| | | | |
|--------------|-----|---|----|
| 53409 | 0,3 | 8 | 48 |
| 8,50€ | Kg | | |

50mm



LUCCHETTI RESISTENTI ALL'ACQUA

| | | | |
|--------------|-----|---|----|
| 53399 | 0,9 | 8 | 48 |
| 3,50€ | Kg | | |

30mm

| | | | |
|--------------|-----|---|----|
| 53400 | 0,2 | 8 | 48 |
| 4,00€ | Kg | | |

40mm

| | | | |
|--------------|------|---|----|
| 53401 | 0,35 | 8 | 48 |
| 5,00€ | Kg | | |

50mm

| | | | |
|--------------|-----|----|----|
| 53402 | 0,6 | 10 | 40 |
| 8,50€ | Kg | | |

65mm



CON COPERCHIO DI PROTEZIONE



SET DI PINZE ELETTRICHE

| | | | | | | |
|--------------|------|---|----|-----|-----|--|
| 53357 | 0,01 | 6 | 24 | 2 | 30 | |
| 4,00€ | Kg | | | PCS | AMP | |



SET DI FUSIBILI MINI

| | | | | | |
|--------------|-----|---|----|-----|--|
| 53355 | 0,2 | 6 | 24 | 120 | |
| 9,50€ | Kg | | | PCS | |

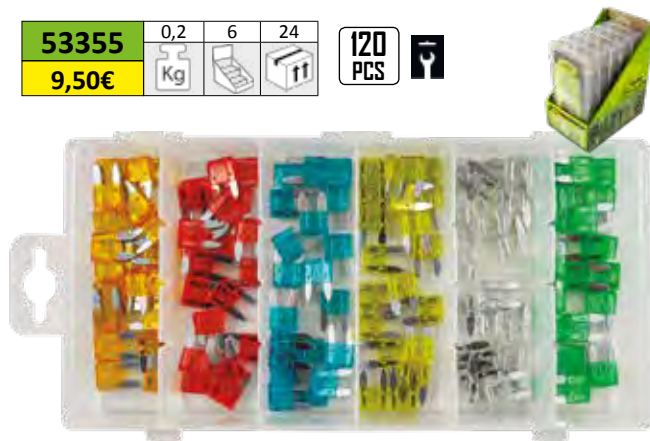

| | | | | | | |
|--|-----|-----|-----|-----|-----|-----|
| | 5A | 10A | 15A | 20A | 25A | 30A |
| | 20 | 20 | 20 | 20 | 20 | 20 |
| | PCS | PCS | PCS | PCS | PCS | PCS |

SET DI FUSIBILI

| | | | | | |
|--------------|------|---|----|-----|--|
| 53356 | 0,25 | 6 | 24 | 120 | |
| 10,50€ | Kg | | | PCS | |



| | | | |
|--|-----|-----|-----|
| | 15A | 20 | |
| | PCS | | |
| | 5A | 10A | |
| | 20 | 20 | |
| | PCS | PCS | |
| | 20A | 25A | 30A |
| | 20 | 20 | 20 |
| | PCS | PCS | PCS |

RICAMBI DISPONIBILI

| REF. | | | €/U. |
|-------|-----|----|-------|
| 10915 | 5A | 20 | 0,14€ |
| 10917 | 10A | 20 | 0,14€ |
| 10918 | 15A | 20 | 0,14€ |
| 10919 | 20A | 20 | 0,14€ |
| 10920 | 25A | 20 | 0,14€ |
| 10921 | 30A | 20 | 0,14€ |

SET DI FUSIBILI

| | | | | | |
|--------------|------|---|----|-----|--|
| 53367 | 0,08 | 6 | 24 | 48 | |
| 7,00€ | Kg | | | PCS | |

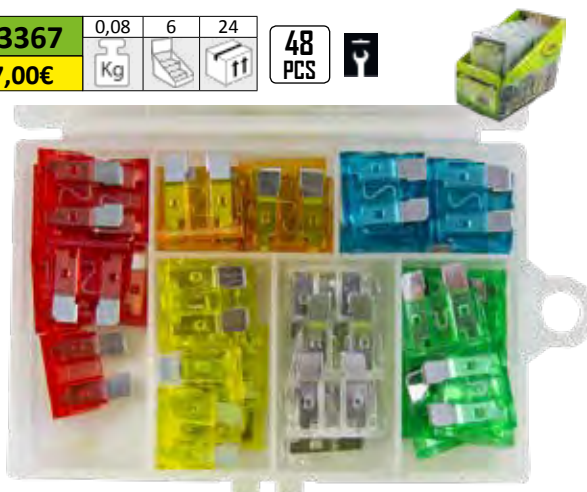

| | | | | | | |
|--|-----|-----|-----|-----|-----|-----|
| | 5A | 10A | 15A | 20A | 25A | 30A |
| | 8 | 8 | 8 | 8 | 8 | 8 |
| | PCS | PCS | PCS | PCS | PCS | PCS |

SET DI FUSIBILI

| | | | | | | |
|--------------|------|---|----|-----|--|---------------|
| 53368 | 0,05 | 6 | 24 | 50 | | Mini fusibili |
| 6,50€ | Kg | | | PCS | | |

| | | | | | | |
|--|-----|-----|-----|-----|-----|-----|
| | 5A | 10A | 15A | 20A | 25A | 30A |
| | 8 | 8 | 8 | 8 | 8 | 10 |
| | PCS | PCS | PCS | PCS | PCS | PCS |



SET DI FUSIBILI

| | | | | | |
|--------------|------|---|----|-------------------|--|
| 53380 | 0,17 | 6 | 24 | 120 PCS | |
| 9,50€ | | | | | |

| | | | |
|--|------------------|------------------|------------------|
| | 5A | 10A | 15A |
| | 20 PCS | 20 PCS | 20 PCS |
| | 20A | 25A | 30A |
| | 20 PCS | 20 PCS | 20 PCS |



SET DI FUSIBILI

| | | | | | | |
|---------------|------|---|----|-----|-------------------|--|
| 52054 | 0,35 | 5 | 25 | 750 | 252 PCS | |
| 16,00€ | | | | | | |



➤ **RICAMBI DISPONIBILI**



MINI XXA

| REF. | COLOR | POTENCIA | U. | €/U. |
|-------|-------|----------|----|-------|
| 10905 | | 3A | 20 | 0,13€ |
| 10906 | | 4A | 20 | 0,13€ |
| 10907 | | 5A | 20 | 0,13€ |



MINI XXA

| REF. | COLOR | POTENCIA | U. | €/U. |
|-------|-------|----------|----|-------|
| 10908 | | 7,5A | 20 | 0,13€ |
| 10909 | | 10A | 20 | 0,13€ |
| 10910 | | 15A | 20 | 0,13€ |



MINI XXA

| REF. | COLOR | POTENCIA | U. | €/U. |
|-------|-------|----------|----|-------|
| 10911 | | 20A | 20 | 0,13€ |
| 10912 | | 25A | 20 | 0,13€ |
| 10913 | | 30A | 20 | 0,13€ |



STANDARD XXA

| REF. | COLOR | POTENCIA | U. | €/U. |
|-------|-------|----------|----|-------|
| 10914 | | 4A | 8 | 0,14€ |
| 10915 | | 5A | 8 | 0,14€ |
| 12954 | | 3A | 8 | 0,14€ |



STANDARD XXA

| REF. | COLOR | POTENCIA | U. | €/U. |
|-------|-------|----------|----|-------|
| 10916 | | 7,5A | 8 | 0,14€ |
| 10917 | | 10A | 8 | 0,14€ |
| 10918 | | 15A | 8 | 0,14€ |



STANDARD XXA

| REF. | COLOR | POTENCIA | U. | €/U. |
|-------|-------|----------|----|-------|
| 10919 | | 20A | 8 | 0,14€ |
| 10920 | | 25A | 8 | 0,14€ |
| 10921 | | 30A | 8 | 0,14€ |

ASTUCCIO DI TERMINALI

| | | | | | |
|---------------|-----|---|----|-----|-------------------|
| 52053 | 0,6 | 6 | 12 | 800 | 635 PCS |
| 31,00€ | | | | | |



➤ **RICAMBI DISPONIBILI**



| REF. | COLOR | MISURA | U. | €/U. |
|-------|-------|-----------|----|-------|
| 10885 | | RV1.25-4S | 50 | 0,09€ |
| 10886 | | RV2-4S | 50 | 0,09€ |
| 10887 | | RV2-6S | 30 | 0,13€ |
| 10888 | | RV5.5-6S | 20 | 0,18€ |
| 10889 | | RV5.5-5S | 20 | 0,18€ |
| 10893 | | RV2-5S | 40 | 0,13€ |



| REF. | COLOR | MISURA | U. | €/U. |
|-------|-------|--------|----|-------|
| 10890 | | BV5.5 | 15 | 0,21€ |
| 10891 | | BV2 | 25 | 0,13€ |
| 10892 | | BV1.25 | 30 | 0,13€ |



| REF. | COLOR | MISURA | U. | €/U. |
|-------|-------|-------------|----|-------|
| 10902 | | FDN1.25-250 | 25 | 0,21€ |



| REF. | COLOR | MISURA | U. | €/U. |
|-------|-------|--------|----|-------|
| 10894 | | SV1-4S | 50 | 0,09€ |
| 10895 | | SV2-4S | 40 | 0,09€ |



| REF. | COLOR | MISURA | U. | €/U. |
|-------|-------|-------------|----|-------|
| 10896 | | FDD1.25-250 | 45 | 0,13€ |
| 10898 | | FDD2-250 | 40 | 0,13€ |
| 10900 | | FDD5.5-250 | 25 | 0,13€ |



| REF. | COLOR | MISURA | U. | €/U. |
|-------|-------|-------------|----|-------|
| 10897 | | MDD1.25-250 | 50 | 0,13€ |
| 10899 | | MDD2-250 | 50 | 0,13€ |
| 10901 | | MDD5.5-250 | 30 | 0,13€ |

ASSORTIMENTO CLIP DI FISSAGGIO

PINZA PER RIMOZIONE RIVETTI

| | | | | |
|---------------|------|---|----|-----|
| 53385 | 0,15 | 6 | 54 | 499 |
| 16,00€ | Kg | | | |



TAGLIO

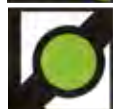

ESTRATTO



BRIGLIA



PUNTA ANGOLATA:

Progettato per estrarre / tagliare graffette / clip facilmente e senza danni.

Consente un facile accesso alle aree ristrette.

PER MAZDA

| | | | | |
|---------------|------|---|----|-----|
| 52896 | 0,17 | 6 | 24 | 168 |
| 22,00€ | Kg | | | |

190 PCS

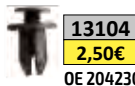

13104
2,50€ 8
OE 2042301



13105
4,00€ 15
OE 999100402



13106
2,50€ 8
OE B0016830200



13107
2,50€ 8
OE N30413356A



13108
5,50€ 20
OE 992640543A

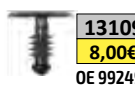

13109
8,00€ 30
OE 99249051B

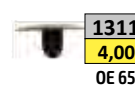

13110
4,00€ 15
OE 6508197AA

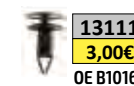

13111
3,00€ 10
OE B1016825200



13112
2,00€ 6
OE B09251833

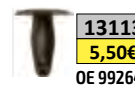

13113
5,50€ 20
OE 992640543A

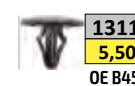

13114
5,50€ 20
OE B45556741

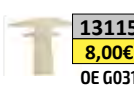

13115
8,00€ 30
OE G03158762

PER TOYOTA / LEXUS

| | | | | |
|---------------|------|---|----|-----|
| 52886 | 0,18 | 6 | 24 | 504 |
| 17,50€ | Kg | | | |

89 PCS



13002
3,50€ 8
OE 9018906001



13003
2,00€ 4
OE 9046707138

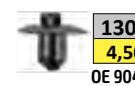

13004
4,50€ 10
OE 9046707117

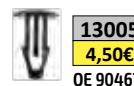

13005
4,50€ 10
OE 9046709138

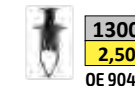

13006
2,50€ 5
OE 9046709101



13007
4,50€ 10
OE 75521611000



13008
3,50€ 8
OE 7503933060

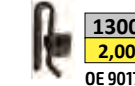

13009
2,00€ 4
OE 9017905060



13010
3,50€ 8
OE 677711250

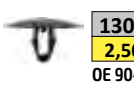

13011
2,50€ 5
OE 9046708124

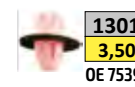

13012
3,50€ 8
OE 7539533030

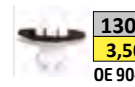

13013
3,50€ 8
OE 9046711063

PER HONDA

| | | | | |
|---------------|------|---|----|-----|
| 52887 | 0,18 | 6 | 24 | 168 |
| 19,00€ | Kg | | | |

150 PCS

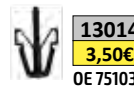

13014
3,50€ 12
OE 75103514003

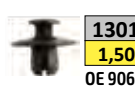

13015
1,50€ 5
OE 906755B003



13016
2,00€ 6
OE 915665P0003

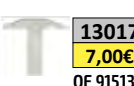

13017
7,00€ 25
OE 915135E003

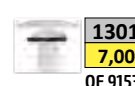

13018
7,00€ 25
OE 915305T5003

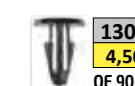

13019
4,50€ 15
OE 906875A50030

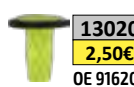

13020
2,50€ 8
OE 916205R2003

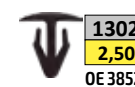

13021
2,50€ 8
OE 38529689A6300



13022
3,00€ 10
OE 906835A5003

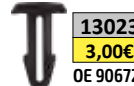

13023
3,00€ 10
OE 90672671003

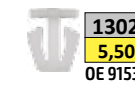

13024
5,50€ 18
OE 915345E0000



13025
2,50€ 8
OE 343555D2003

PER PEUGEOT / CITROËN

| | | | | |
|---------------|-----|---|----|-----|
| 52899 | 0,5 | 6 | 24 | 360 |
| 27,50€ | Kg | | | |

345 PCS

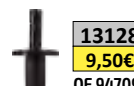

13128
9,50€ 50
OE 947098

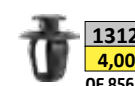

13129
4,00€ 20
OE 856535

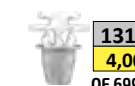

13130
4,00€ 20
OE 6991WK

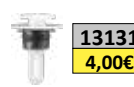

13131
4,00€ 20
OE 694143

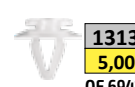

13132
5,00€ 25
OE 694143

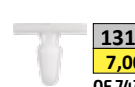

13133
7,00€ 35
OE 743707

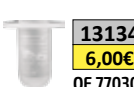

13134
6,00€ 30
OE 7703074022

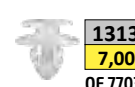

13135
7,00€ 35
OE 7703077059



13136
3,00€ 15
OE 698317

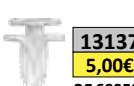

13137
5,00€ 25
OE 699502

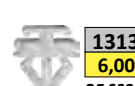

13138
6,00€ 30
OE 6995X3















13139
7,50€ 40
OE 69945

ASSORTIMENTO CLIP DI FISSAGGIO

PER FIAT

| | | | | | |
|-------|--------|----|-----|-----|------------|
| 52900 | 0,5 | 6 | 24 | 360 | 308 PCS |
| | 27,00€ | Kg | sub | ff | |















| | | |
|--|--|--|
|  13140 6,50€ OE 14591784 |  13141 4,50€ OE 1459487 |  13142 5,50€ OE 1300433650 |
|  13143 2,00€ OE 71717421 |  13144 5,50€ OE 82456515 |  13145 5,50€ OE 5757139 |
|  13146 4,00€ OE 14592387 |  13147 5,50€ OE 46306526 |  13148 5,50€ OE 14591687 |
|  13149 5,50€ OE 14592387 |  13150 6,50€ OE 83468473 |  13151 10,50€ OE 7677865 |

PER VOLVO

| | | | | | |
|-------|--------|----|-----|-------|------------|
| 52901 | 0,48 | 6 | 24 | 1.500 | 350 PCS |
| | 30,50€ | Kg | sub | ff | |



| | | |
|---|--|--|
|  13152 5,50€ OE 8099905N07 |  13153 6,50€ OE 4292906 |  13154 4,50€ OE 12681763 |
|  13155 8,50€ OE 51131804205 |  13156 8,50€ OE 947098 |  13157 8,50€ OE 591740 |
|  13158 5,50€ OE 6384801G00 |  13159 4,50€ OE 9133417 |  13160 8,50€ OE 9133073 |
|  13161 6,50€ OE 3272075327462B |  13162 4,50€ OE 327462A |  13163 4,50€ OE 3923712 |

PER VOLSKWAGEN

| | | | | | |
|-------|--------|----|-----|-----|-----------|
| 52889 | 0,18 | 6 | 24 | 504 | 85 PCS |
| | 17,00€ | Kg | sub | ff | |















| | | |
|---|--|---|
|  13038 0,84€ OE 1H0868243B |  13039 4,50€ OE N90833801 |  13040 3,50€ OE 3A0853575 |
|  13041 2,50€ OE 4A0853825 |  13042 6,50€ OE 6U085733 |  13043 1,50€ OE 3B0853576 |
|  13044 3,00€ OE 1H0819055B01C |  13045 2,50€ OE 443853909A |  13046 3,00€ OE 171885767 |
|  13047 2,50€ OE N9020160H |  13048 4,50€ OE N0385501 |  13049 4,50€ OE 191941142 |

PER FORD

| | | | | | |
|-------|--------|----|-----|-----|------------|
| 52891 | 0,16 | 6 | 24 | 672 | 169 PCS |
| | 20,50€ | Kg | sub | ff | |



| | | |
|--|---|--|
|  13056 2,50€ OE 3885775 |  13057 1,50€ OE N8019255 |  13058 5,50€ OE N8062895 |
|  13059 5,50€ OE N3798305 |  13060 1,50€ OE 1007932 |  13061 5,50€ OE 16500308 |
|  13062 5,50€ OE N8031705 |  13063 2,00€ OE W7067135300 |  13064 5,50€ OE N3882465 |
|  13065 4,00€ OE F22216774A |  13066 1,50€ OE 1673046 |  13067 7,00€ OE FIC216674A |

ASSORTIMENTO CLIP DI FISSAGGIO

PER NISSAN

| | | | | | |
|---------------|------|---|----|-----|-------------------|
| 52894 | 0,19 | 6 | 24 | 216 | 139 PCS |
| 18,00€ | Kg | | | | |



| | | | | | |
|----------------|-----------------------------|---------------|-----------------------------|---------------|-----------------------------|
| | 13080 4,50€ 15 | | 13081 6,00€ 20 | | 13082 3,00€ 10 |
| OE 76906T300 | | OE 0155300172 | | OE 68425H5000 | |
| | 13083 2,00€ 6 | | 13084 6,00€ 20 | | 13085 1,50€ 5 |
| OE 75521611000 | | OE 62869N4700 | | OE 6384401A00 | |
| | 13086 1,50€ 5 | | 13087 7,50€ 25 | | 13088 3,00€ 10 |
| OE 7688257A00 | | OE 6684101G00 | | OE 1099830880 | |
| | 13089 3,00€ 10 | | 13090 2,50€ 8 | | 13091 1,50€ 5 |
| OE 8942798070 | | OE 6384801G00 | | OE 6385401A00 | |

PER AUDI

| | | | | | |
|---------------|------|---|----|-----|------------------|
| 52890 | 0,16 | 6 | 24 | 504 | 31 PCS |
| 16,00€ | Kg | | | | |



| | | | | | |
|--------------|------------------------------|---------------|----------------------------|---------------|----------------------------|
| | 13050 2,50€ 5 | | 13051 5,50€ 5 | | 13052 3,50€ 3 |
| OE 3B0868243 | | OE 1H0867199A | | OE 1H0868243B | |
| | 13053 10,50€ 10 | | 13054 5,50€ 5 | | 13055 3,50€ 3 |
| OE 357853575 | | OE 1H0853585A | | OE 3A0853575 | |

PER BMW

| | | | | | |
|---------------|------|---|----|-----|------------------|
| 52892 | 0,17 | 6 | 24 | 672 | 95 PCS |
| 16,00€ | Kg | | | | |



| | | | | | |
|----------------|-----------------------------|----------------|------------------------------|----------------|-----------------------------|
| | 13068 9,00€ 25 | | 13069 11,00€ 30 | | 13070 4,00€ 10 |
| OE 51311802258 | | OE 51131804205 | | OE 51118174185 | |
| | 13071 4,00€ 10 | | 13072 5,50€ 15 | | 13073 2,00€ 5 |
| OE 51481938725 | | OE 703867299 | | OE 51131960054 | |

PER BENZ

| | | | | | |
|---------------|-----|---|----|-----|------------------|
| 52893 | 0,2 | 6 | 24 | 504 | 95 PCS |
| 20,50€ | Kg | | | | |



| | | | | | |
|----------------|------------------------------|----------------|-----------------------------|----------------|-----------------------------|
| | 13074 13,50€ 30 | | 13075 9,00€ 20 | | 13076 7,00€ 15 |
| OE A0019884481 | | OE A0019882981 | | OE A1249900492 | |
| | 13077 2,00€ 4 | | 13078 3,00€ 6 | | 13079 9,00€ 20 |
| OE A0019888081 | | OE A1249880492 | | OE A0019880325 | |

ASSORTIMENTO CLIP DI FISSAGGIO

PER RENAULT

| | | | | | |
|---------------|------|---|----|-----|--------------------|
| 52897 | 0,43 | 6 | 24 | 360 | 300 PCS |
| 34,00€ | Kg | | | | |



| | | | | | |
|--|--------------|--|---------------|----|---------------|
| | 13116 | | 13,00€ | 50 | OE 7703077421 |
| | 13117 | | 13,00€ | 50 | |
| | 13118 | | 15,50€ | 60 | OE 7703081184 |
| | 13119 | | 4,00€ | 15 | |
| | 13120 | | 15,50€ | 60 | OE 7703074022 |
| | 13121 | | 16,50€ | 65 | OE 7703077059 |

PER MITSUBISHI

| | | | | | |
|---------------|------|---|----|-------|--------------------|
| 52895 | 0,19 | 6 | 24 | 1.500 | 132 PCS |
| 18,00€ | Kg | | | | |



| | | | | | |
|--|--------------|--|--------------|----|---------------|
| | 13092 | | 4,50€ | 15 | OE 8942180270 |
| | 13093 | | 9,00€ | 30 | OE 9018905013 |
| | 13094 | | 3,00€ | 10 | OE MU480033 |
| | 13095 | | 2,00€ | 6 | OE 128100231 |
| | 13096 | | 2,50€ | 8 | OE MU480034 |
| | 13097 | | 0,88€ | 3 | OE MR138807 |
| | 13098 | | 1,50€ | 4 | OE MB253964 |
| | 13099 | | 9,00€ | 30 | OE HB121467 |
| | 13100 | | 0,88€ | 3 | OE MB271999 |
| | 13101 | | 2,50€ | 8 | OE MB696120 |
| | 13102 | | 1,50€ | 5 | OE MR200300 |
| | 13103 | | 3,00€ | 10 | OE MB846992 |

PER VAUXHALL / OPEL

| | | | | | |
|---------------|------|---|----|-----|--------------------|
| 52898 | 0,45 | 6 | 24 | 360 | 300 PCS |
| 27,00€ | Kg | | | | |



| | | | | | |
|--|--------------|--|---------------|-----|-------------|
| | 13122 | | 4,50€ | 20 | OE 90218614 |
| | 13123 | | 8,50€ | 40 | OE 174864 |
| | 13124 | | 11,50€ | 100 | OE N0385501 |
| | 13125 | | 10,50€ | 50 | OE 2345959 |
| | 13126 | | 10,50€ | 50 | OE 2240582 |
| | 13127 | | 8,50€ | 40 | OE 180942 |

UNIVERSALE

| | | | | | |
|---------------|------|---|----|-----|--------------------|
| 52888 | 0,17 | 6 | 24 | 672 | 128 PCS |
| 20,00€ | Kg | | | | |



| | | | | | |
|--|--------------|--|--------------|----|---|
| | 13026 | | 2,50€ | 8 | OE 3885775 |
| | 13027 | | 3,50€ | 10 | GENERAL USE |
| | 13028 | | 2,00€ | 6 | OE 6003423 |
| | 13029 | | 2,00€ | 6 | VW: N989022 Chrysler: 6003349 Ford: 385661 |
| | 13030 | | 8,00€ | 25 | GM: 20699808 Chrysler: 6502328 |
| | 13031 | | 1,50€ | 4 | Ford: N8043795 |
| | 13032 | | 5,00€ | 15 | Mazda: 6508197AA Ford: F22216774A |
| | 13033 | | 3,50€ | 10 | GM: 16674629 Ford: N8061135 |
| | 13034 | | 6,50€ | 20 | Nissan: 0153301781 |
| | 13035 | | 2,00€ | 6 | GM: 10124502 BMW: 52201964201 Land Rover: DZM100080 |
| | 13036 | | 2,00€ | 6 | VW: N9020160H Ford: 6998849 BMW: 51471904317 Opel: 2207713 |
| | 13037 | | 4,00€ | 12 | GENERAL USE |



ABBIGLIAMENTO

- GILET 261
- GIACCA 261



GILET JBM

TAGLIA M

| | | | | |
|---------------|-----|---|-----|--|
| 70001 | 0,3 | 5 | 180 | |
| 35,50€ | Kg | | | |

| | | | | |
|---------------|-----|---|-----|--|
| 70007 | 0,3 | 5 | 180 | |
| 35,50€ | Kg | | | |

TAGLIA L

| | | | | |
|---------------|-----|---|-----|--|
| 70002 | 0,4 | 5 | 180 | |
| 35,50€ | Kg | | | |

| | | | | |
|---------------|-----|---|-----|--|
| 70008 | 0,4 | 5 | 180 | |
| 35,50€ | Kg | | | |

TAGLIA XL

| | | | | |
|---------------|-----|---|-----|--|
| 70003 | 0,4 | 5 | 180 | |
| 35,50€ | Kg | | | |

| | | | | |
|---------------|-----|---|-----|--|
| 70009 | 0,4 | 5 | 180 | |
| 35,50€ | Kg | | | |



Due tasche interne di grande capacità



2 tasche laterali



Resistente al freddo



Termico



Leggera



GIACCA JBM

TAGLIA M

| | | | | |
|---------------|-----|---|-----|--|
| 70004 | 0,6 | 5 | 120 | |
| 42,00€ | Kg | | | |

| | | | | |
|---------------|-----|---|-----|--|
| 70010 | 0,6 | 5 | 120 | |
| 42,00€ | Kg | | | |

TAGLIA L

| | | | | |
|---------------|-----|---|-----|--|
| 70005 | 0,7 | 5 | 120 | |
| 42,00€ | Kg | | | |

| | | | | |
|---------------|-----|---|-----|--|
| 70011 | 0,6 | 5 | 120 | |
| 42,00€ | Kg | | | |

TAGLIA XL

| | | | | |
|---------------|-----|---|-----|--|
| 70006 | 0,7 | 5 | 120 | |
| 42,00€ | Kg | | | |

| | | | | |
|---------------|-----|---|-----|--|
| 70012 | 0,7 | 5 | 120 | |
| 42,00€ | Kg | | | |



Collo alto e carniera frontale



3 tasche esterne



Small, illegible text in a grid pattern, likely a promotional message or list of items.



PROMOZIONALE

ESPOSITORE ATTREZZATURA 263

PROMOZIONALE 264



ESPOSITORE ATTREZZATURA VUOTO

| | | | |
|----------------|-------|---|---|
| 51288 | 52,85 | 1 | 8 |
| 467,50€ | Kg | | |

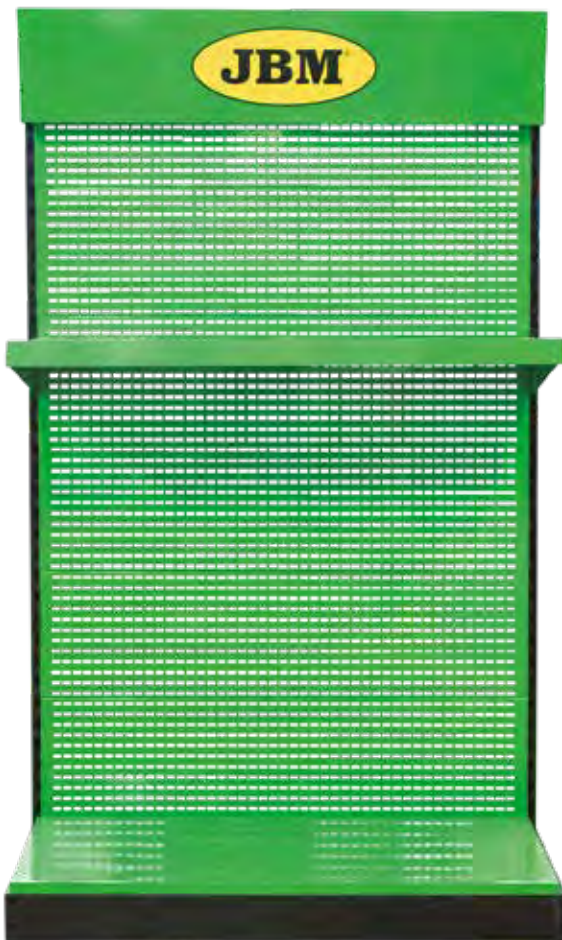

VASCHETTA + 2 SUPPORTI

| | | | |
|---------------|------|--|--|
| 51289 | | | |
| 55,50€ | | | |
| Kg | 5,05 | | |
| | 6 | | |
| | 72 | | |

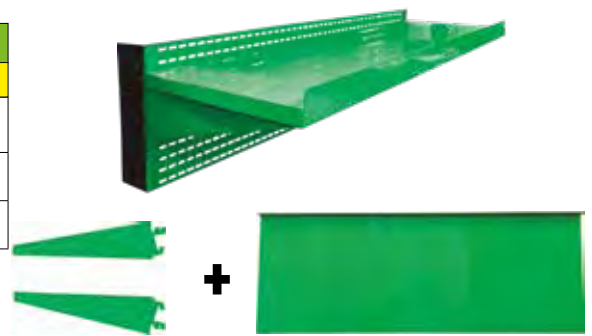

GANCIO

DRITTO

| | | | |
|--------------|------|----|-----|
| 11318 | 0,04 | 20 | 600 |
| 3,00€ | Kg | | |



DOPPIO CHIUSO

| | | | |
|--------------|------|----|-----|
| 51315 | 0,03 | 20 | 280 |
| 3,00€ | Kg | | |

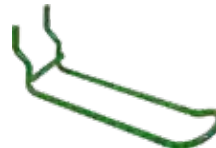

PER UTENSILI PNEUMATICI

| | | | | |
|--------------|-----|----|----|-------|
| 14034 | 0,2 | 20 | 80 | 1.920 |
| 7,50€ | Kg | | | |

← 106mm →



N

ESPOSITORI PER TAPPETINI

| | | | |
|---------------|----|---|----|
| METEXP | 6 | 1 | 16 |
| 53,00€ | Kg | | |



ESPOSITORI DI UTENSILI PNEUMATICI

| | | | |
|----------------|----|---|---|
| 53492 | 13 | 1 | 7 |
| 291,50€ | Kg | | |

CONSEGNATO SENZA UTENSILE



N

SEDIA ROTATIVA

N

| | |
|----------------|--|
| 53521 | |
| 273,00€ | |
| 21,3 | |
| 1 | |
| 6 | |

135Kg



ALTEZZA
REGOLABILE

Design ergonomico

Rivestimento in PU resistente,
facile da pulire

Comfort ottimale, aspetto sportivo
e materiali di qualità



INSULATED TERMICA SACCHETTO

| | | | |
|--------------|------|----|-----|
| 51688 | 0,31 | 50 | 300 |
| 5,00€ | | | |



SACCHETTO JBM

| | |
|--------------|--|
| 13968 | |
| 3,50€ | |
| 0,01 | |
| 50 | |
| 800 | |
| 3.200 | |



OMBRELLIO JBM PROMOZIONALE

| | | | | |
|--------------|------|----|----|-----|
| 52857 | 0,31 | 10 | 60 | 540 |
| 6,50€ | | | | |

84cm



STAND TENDA JBM 3x3m

| | | |
|----------------|----|---|
| 52995 | 20 | 1 |
| 214,50€ | | |



13446 87,00€

COPERTURA LATERALE PER REF. 52995

POLO JBM

TAGLIA S

| | |
|---------------|-----|
| 13242 | 0,2 |
| 14,00€ | Kg |

TAGLIA L

| | |
|---------------|------|
| 13244 | 0,26 |
| 14,00€ | Kg |

TAGLIA M

| | |
|---------------|------|
| 13243 | 0,25 |
| 14,00€ | Kg |

TAGLIA XL

| | |
|---------------|------|
| 13245 | 0,28 |
| 14,00€ | Kg |

| | |
|-----|-----|
| 100 | 600 |
| | |



SET DI 2 SALVIETTE

N

| | | | | |
|---------------|------|----|-----|----------|
| 53510 | 0,65 | 25 | 100 | 2 |
| 12,50€ | Kg | | | PCS |



COLLANA DI PERLE

N

| | | | |
|---------------|------|---|-----|
| 53513 | 0,05 | 9 | 500 |
| 13,80€ | Kg | | |



SCOOTER

N

| | | | |
|---------------|-----|---|----|
| 53504 | 3,5 | 6 | 36 |
| 53,00€ | Kg | | |

77x100mm



REGOLABILE



SET DI 3 CORTELLI

N

| | | | | |
|---------------|-----|---|----|-----|
| 53511 | 0,7 | 5 | 20 | 360 |
| 16,50€ | Kg | | | |

3
PCS



POSATERIA

N









| | | | |
|---------------|-----|----|-----|
| 53512 | 1,9 | 12 | 144 |
| 50,00€ | Kg | | |

24
PCS



LEGGENDA

Leggenda dati riferimenti

-  Peso del articolo in kilogramos
-  Quantità di articoli per subcaja
-  Quantità di articoli per espositore
-  Quantità di articoli per sachetto
-  Quantità di articoli per scatola
-  Quantità di sachetti per scatola
-  Quantità di articoli per pallet
-  Presentato in blister
-  Prodotto nuovo

Leggenda caratteristiche generali

-  Capacità per dimensioni
-  Magnetizzato
-  Peso che supporta il magnete
-  Peso che supporta l'articolo
-  Livello di rumore (decibel)
-  Peso
-  Peso leggero
-  Zoom
-  Connessione bluetooth
-  Connessione USB
-  Materiale di Alluminio
-  Cromata

Leggenda degli strumenti

-  Bussola quadrata
-  Bussola di 12
-  Bussola di 12 (2)
-  Bussole esagonale
-  Bussole XZN
-  Bussole Twist
-  Bussole Spline
-  Punta Slotted
-  Punta ribe
-  Punta Phillips (stella)
-  Punta pozidriv (doppia stella)
-  Cuatri punta
-  Punta torx inviolabile
-  Punta torx inviolabile-XZN
-  Punta torx
-  Tri punta
-  Punta TS 5 facce
-  Punta di 12 canti
-  Punta del tensore
-  Allen
-  Cabota normale
-  Cabota rotonda



Leggenda prodotti pneumatici

-  Rivoluzioni al minuto (generale)
-  Revoluciones al minuto (avanti)
-  Revoluciones al minuto (al contrario)
-  Newton-metro (Nm)/ chilogrammo
-  Libbra per pollice quadrata
-  Unità di pressione
-  Ingresso dell'aria
-  Uscita dell'aria
-  Uscita posteriore da 360°
-  Uscita frontale
-  Uscita frontale
-  Uscita frontale
-  Bassa vibrazione
-  Misure della pistola
-  Maniglia ergonomico
-  vibrazione
-  Orbita del disco
-  Diametro del disco
-  Dimensione della punta di trapano
-  Misura di entrata del trapano
-  Movimenti an360°
-  N° da velocità
-  Cavalli di forza
-  Meccanismo a doppio martello
-  Ultra potente
-  Angolo di 90°



LEGGENDA

Leggenda di prodotti elettronici



-  Tipo di LED: SMD
-  Tipo di LED: COB
-  Tipo di LED: Cree XP-E
-  Quantità / potenza Leds
-  Quantità di Leds
-  Distanza di illuminazione
-  3 intensità di luce
-  Flusso luminoso
-  Luce diffusa
-  Luce concentrata
-  Numero di tipi di flash
-  Potenza di Volt/Watt
-  Durata della batteria
-  Durata del carico
-  Tipo di batteria
-  Quantità di batterie AAA
-  Trasformatore / presa a muro
-  Caricabatterie USB
-  Presa di accendisigari
-  Base reclinabile
-  Base reclinabile
-  attaccapanni
-  Attaccapanni girevole
-  Lunghezza del cavo

-  Resistente agli colpi
-  Grado de protezione IP
-  magnetizzato



Leggenda prodotti utensili

-  Compressore di molla
-  Smontaggio ammortizzatore



Leggenda prodotti lubrificanti

-  Capacità di imbuto
-  Flusso d'aria

Leggenda accessori

-  Raggiunge li 1.300°
-  Due tipi di fiammata

Leggenda certificato

-  Certificato CE
-  Regolamenti in base ai guanti protettivi
-  Conformità con la legge tedesca sulla sicurezza dei prodotti (ProdSG)



INDICE NUMERICO

| REF. | pag. | € |
|-------|------|---------|
| 10000 | 194 | 8,00 € |
| 10054 | 142 | 2,00 € |
| 10055 | 142 | 2,50 € |
| 10117 | 28 | 0,80 € |
| 10118 | 28 | 0,80 € |
| 10119 | 28 | 0,80 € |
| 10120 | 28 | 0,80 € |
| 10121 | 28 | 0,80 € |
| 10122 | 28 | 0,80 € |
| 10123 | 28 | 0,80 € |
| 10124 | 28 | 0,80 € |
| 10125 | 28 | 0,80 € |
| 10126 | 28 | 0,80 € |
| 10127 | 28 | 0,80 € |
| 10128 | 28 | 0,80 € |
| 10129 | 28 | 0,80 € |
| 10130 | 28 | 0,80 € |
| 10131 | 28 | 0,80 € |
| 10132 | 28 | 0,80 € |
| 10133 | 28 | 0,80 € |
| 10134 | 28 | 0,80 € |
| 10135 | 28 | 0,60 € |
| 10136 | 28 | 0,60 € |
| 10137 | 28 | 0,90 € |
| 10138 | 28 | 1,00 € |
| 10139 | 28 | 1,50 € |
| 10140 | 28 | 0,90 € |
| 10141 | 28 | 1,00 € |
| 10142 | 28 | 0,60 € |
| 10143 | 28 | 0,60 € |
| 10145 | 28 | 0,60 € |
| 10146 | 28 | 0,60 € |
| 10147 | 28 | 0,60 € |
| 10148 | 28 | 0,60 € |
| 10149 | 28 | 0,60 € |
| 10150 | 28 | 0,70 € |
| 10151 | 28 | 0,90 € |
| 10485 | 144 | 10,50 € |
| 10486 | 144 | 10,50 € |
| 10494 | 144 | 6,00 € |
| 10495 | 144 | 2,50 € |
| 10496 | 144 | 2,50 € |
| 10497 | 144 | 2,50 € |
| 10498 | 144 | 2,50 € |
| 10499 | 144 | 2,50 € |
| 10500 | 144 | 2,50 € |
| 10501 | 144 | 9,50 € |
| 10502 | 144 | 3,50 € |

| REF. | pag. | € |
|-------|------|---------|
| 10527 | 33 | 43,00 € |
| 10528 | 33 | 46,00 € |
| 10529 | 33 | 49,00 € |
| 10530 | 33 | 52,50 € |
| 10552 | 32 | 17,50 € |
| 10553 | 32 | 18,00 € |
| 10554 | 32 | 18,50 € |
| 10555 | 32 | 19,50 € |
| 10556 | 32 | 20,50 € |
| 10557 | 32 | 21,00 € |
| 10558 | 32 | 22,00 € |
| 10559 | 32 | 23,00 € |
| 10560 | 32 | 24,50 € |
| 10561 | 32 | 25,50 € |
| 10562 | 32 | 26,50 € |
| 10563 | 32 | 27,50 € |
| 10621 | 34 | 11,00 € |
| 10622 | 34 | 12,00 € |
| 10623 | 34 | 14,00 € |
| 10624 | 34 | 15,50 € |
| 10625 | 34 | 18,00 € |
| 10626 | 34 | 20,50 € |
| 10639 | 199 | 12,00 € |
| 10671 | 204 | 17,00 € |
| 10672 | 155 | 18,50 € |
| 10673 | 155 | 18,50 € |
| 10674 | 155 | 18,50 € |
| 10675 | 155 | 18,50 € |
| 10676 | 65 | 12,00 € |
| 10677 | 65 | 13,00 € |
| 10678 | 65 | 11,50 € |
| 10679 | 65 | 20,50 € |
| 10680 | 65 | 23,50 € |
| 10720 | 212 | 16,50 € |
| 10721 | 212 | 21,00 € |
| 10722 | 212 | 16,50 € |
| 10723 | 212 | 16,00 € |
| 10724 | 212 | 16,00 € |
| 10726 | 65 | 18,50 € |
| 10727 | 65 | 20,50 € |
| 10728 | 65 | 28,00 € |
| 10729 | 65 | 42,00 € |
| 10730 | 65 | 36,00 € |
| 10731 | 65 | 15,00 € |
| 10732 | 65 | 19,00 € |
| 10733 | 65 | 15,50 € |
| 10735 | 65 | 18,00 € |
| 10736 | 65 | 6,50 € |

| REF. | pag. | € |
|-------|---------|----------|
| 10750 | 85 | 14,50 € |
| 10751 | 85 | 16,50 € |
| 10761 | 212 | 18,00 € |
| 10762 | 212 | 18,50 € |
| 10766 | 85/91 | 3,50 € |
| 10767 | 195 | 23,50 € |
| 10768 | 199 | 123,50 € |
| 10769 | 199 | 20,00 € |
| 10770 | 199 | 7,00 € |
| 10772 | 247 | 0,02 € |
| 10773 | 247 | 0,06 € |
| 10774 | 247 | 0,09 € |
| 10775 | 247 | 0,13 € |
| 10776 | 247 | 0,18 € |
| 10777 | 247 | 0,21 € |
| 10778 | 247 | 0,35 € |
| 10779 | 245/247 | 0,50 € |
| 10780 | 245/247 | 0,50 € |
| 10781 | 245/247 | 0,50 € |
| 10782 | 247 | 0,02 € |
| 10783 | 247 | 0,04 € |
| 10784 | 245/247 | 0,50 € |
| 10785 | 245/247 | 0,06 € |
| 10786 | 245/247 | 0,11 € |
| 10787 | 247 | 0,50 € |
| 10788 | 247 | 0,50 € |
| 10789 | 247 | 0,50 € |
| 10790 | 247 | 0,02 € |
| 10791 | 247 | 0,03 € |
| 10792 | 247 | 0,04 € |
| 10793 | 244 | 0,15 € |
| 10794 | 244 | 0,29 € |
| 10795 | 244 | 0,46 € |
| 10805 | 245 | 0,06 € |
| 10812 | 245 | 0,22 € |
| 10813 | 245 | 0,28 € |
| 10823 | 250 | 0,10 € |
| 10824 | 250 | 0,10 € |
| 10825 | 250 | 0,10 € |
| 10826 | 250 | 0,21 € |
| 10827 | 250 | 0,25 € |
| 10828 | 250 | 0,25 € |
| 10829 | 250 | 0,10 € |
| 10830 | 250 | 0,10 € |
| 10831 | 250 | 0,10 € |
| 10832 | 250 | 0,10 € |
| 10833 | 250 | 0,10 € |
| 10834 | 250 | 0,13 € |

| REF. | pag. | € |
|-------|------|--------|
| 10835 | 250 | 0,13 € |
| 10836 | 250 | 0,18 € |
| 10837 | 250 | 0,18 € |
| 10838 | 250 | 0,18 € |
| 10839 | 250 | 0,21 € |
| 10840 | 250 | 0,13 € |
| 10868 | 252 | 0,17 € |
| 10869 | 252 | 0,22 € |
| 10870 | 252 | 0,28 € |
| 10871 | 252 | 0,22 € |
| 10872 | 252 | 0,39 € |
| 10873 | 252 | 0,39 € |
| 10874 | 252 | 0,22 € |
| 10875 | 252 | 0,39 € |
| 10876 | 252 | 0,39 € |
| 10877 | 246 | 0,13 € |
| 10878 | 246 | 0,17 € |
| 10879 | 246 | 0,10 € |
| 10880 | 246 | 0,12 € |
| 10881 | 246 | 0,14 € |
| 10882 | 244 | 0,12 € |
| 10883 | 244 | 0,11 € |
| 10884 | 244 | 0,12 € |
| 10885 | 255 | 0,09 € |
| 10886 | 255 | 0,09 € |
| 10887 | 255 | 0,13 € |
| 10888 | 255 | 0,18 € |
| 10889 | 255 | 0,18 € |
| 10890 | 255 | 0,21 € |
| 10891 | 255 | 0,13 € |
| 10892 | 255 | 0,13 € |
| 10893 | 255 | 0,13 € |
| 10894 | 255 | 0,09 € |
| 10895 | 255 | 0,09 € |
| 10896 | 255 | 0,13 € |
| 10897 | 255 | 0,13 € |
| 10898 | 255 | 0,13 € |
| 10899 | 255 | 0,13 € |
| 10900 | 255 | 0,13 € |
| 10901 | 255 | 0,13 € |
| 10902 | 255 | 0,21 € |
| 10905 | 255 | 0,13 € |
| 10906 | 255 | 0,13 € |
| 10907 | 255 | 0,13 € |
| 10908 | 255 | 0,13 € |
| 10909 | 255 | 0,13 € |
| 10910 | 255 | 0,13 € |
| 10911 | 255 | 0,13 € |

| REF. | pag. | € |
|-------|---------|----------|
| 10912 | 255 | 0,13 € |
| 10913 | 255 | 0,13 € |
| 10914 | 255 | 0,14 € |
| 10915 | 254/255 | 0,14 € |
| 10916 | 255 | 0,14 € |
| 10917 | 254/255 | 0,14 € |
| 10918 | 254/255 | 0,14 € |
| 10919 | 254/255 | 0,14 € |
| 10920 | 254/255 | 0,14 € |
| 10921 | 254/255 | 0,14 € |
| 10923 | 80 | 1,50 € |
| 10924 | 80 | 5,00 € |
| 10925 | 195 | 20,00 € |
| 10945 | 224 | 3,00 € |
| 10953 | 145 | 13,50 € |
| 10961 | 78 | 13,50 € |
| 10964 | 219 | 6,00 € |
| 10965 | 219 | 5,50 € |
| 10966 | 219 | 11,00 € |
| 10993 | 205 | 105,50 € |
| 11075 | 214 | 64,00 € |
| 11076 | 214 | 102,00 € |
| 11077 | 214 | 86,00 € |
| 11078 | 214 | 344,50 € |
| 11079 | 214 | 24,50 € |
| 11080 | 214 | 108,00 € |
| 11081 | 214 | 21,50 € |
| 11082 | 214 | 10,00 € |
| 11083 | 214 | 429,00 € |
| 11084 | 214 | 73,50 € |
| 11085 | 214 | 218,00 € |
| 11086 | 214 | 20,00 € |
| 11087 | 205 | 18,00 € |
| 11088 | 205 | 32,00 € |
| 11092 | 81 | 42,00 € |
| 11093 | 78 | 4,50 € |
| 11095 | 212 | 21,50 € |
| 11096 | 212 | 25,00 € |
| 11097 | 212 | 37,00 € |
| 11098 | 212 | 45,00 € |
| 11100 | 213 | 18,00 € |
| 11101 | 213 | 75,00 € |
| 11102 | 213 | 7,50 € |
| 11103 | 85 | 5,50 € |
| 11104 | 200 | 35,50 € |
| 11106 | 132 | 3,50 € |
| 11107 | 78 | 4,50 € |
| 11118 | 65 | 4,50 € |
| 11121 | 113 | 3,00 € |
| 11122 | 113 | 3,50 € |

| REF. | pag. | € |
|-------|------|---------|
| 11123 | 113 | 4,00 € |
| 11124 | 113 | 5,00 € |
| 11125 | 113 | 5,50 € |
| 11126 | 113 | 7,50 € |
| 11127 | 113 | 8,50 € |
| 11128 | 113 | 9,00 € |
| 11129 | 113 | 9,50 € |
| 11130 | 113 | 9,50 € |
| 11131 | 113 | 9,50 € |
| 11132 | 113 | 9,50 € |
| 11133 | 113 | 10,00 € |
| 11134 | 113 | 10,50 € |
| 11135 | 113 | 11,00 € |
| 11136 | 113 | 11,00 € |
| 11137 | 113 | 12,50 € |
| 11138 | 113 | 12,50 € |
| 11139 | 113 | 12,50 € |
| 11140 | 113 | 13,00 € |
| 11141 | 113 | 14,00 € |
| 11142 | 113 | 14,50 € |
| 11143 | 113 | 17,50 € |
| 11144 | 113 | 22,00 € |
| 11145 | 113 | 23,50 € |
| 11146 | 113 | 26,00 € |
| 11147 | 113 | 29,50 € |
| 11148 | 113 | 31,50 € |
| 11149 | 113 | 35,00 € |
| 11150 | 113 | 37,50 € |
| 11151 | 113 | 44,50 € |
| 11152 | 113 | 48,50 € |
| 11153 | 113 | 15,50 € |
| 11154 | 113 | 16,50 € |
| 11155 | 113 | 16,50 € |
| 11156 | 113 | 19,00 € |
| 11157 | 113 | 19,00 € |
| 11158 | 113 | 19,50 € |
| 11159 | 113 | 20,50 € |
| 11160 | 113 | 21,00 € |
| 11161 | 113 | 21,00 € |
| 11162 | 113 | 21,50 € |
| 11163 | 113 | 21,50 € |
| 11164 | 113 | 22,50 € |
| 11165 | 113 | 23,00 € |
| 11166 | 113 | 24,50 € |
| 11167 | 113 | 28,50 € |
| 11168 | 113 | 29,00 € |
| 11169 | 113 | 29,50 € |
| 11170 | 113 | 30,00 € |
| 11171 | 113 | 33,50 € |
| 11172 | 113 | 35,00 € |

| REF. | pag. | € |
|-------|------|----------|
| 11173 | 113 | 35,50 € |
| 11174 | 113 | 36,00 € |
| 11175 | 113 | 36,50 € |
| 11176 | 113 | 38,50 € |
| 11177 | 113 | 41,50 € |
| 11178 | 113 | 42,00 € |
| 11179 | 113 | 46,00 € |
| 11180 | 113 | 49,00 € |
| 11181 | 113 | 49,50 € |
| 11182 | 113 | 53,00 € |
| 11183 | 113 | 55,00 € |
| 11184 | 113 | 66,00 € |
| 11185 | 113 | 68,50 € |
| 11186 | 113 | 69,50 € |
| 11187 | 113 | 75,50 € |
| 11188 | 113 | 76,50 € |
| 11189 | 113 | 87,50 € |
| 11190 | 113 | 106,50 € |
| 11191 | 113 | 106,50 € |
| 11192 | 113 | 117,00 € |
| 11193 | 113 | 125,50 € |
| 11194 | 113 | 136,00 € |
| 11195 | 113 | 2,50 € |
| 11205 | 67 | 2,00 € |
| 11206 | 67 | 2,00 € |
| 11207 | 67 | 3,00 € |
| 11208 | 67 | 3,50 € |
| 11209 | 67 | 5,50 € |
| 11210 | 67 | 5,50 € |
| 11211 | 67 | 8,00 € |
| 11212 | 41 | 5,00 € |
| 11213 | 41 | 10,50 € |
| 11214 | 41 | 12,50 € |
| 11219 | 211 | 606,50 € |
| 11244 | 36 | 13,00 € |
| 11245 | 36 | 15,50 € |
| 11246 | 36 | 18,00 € |
| 11247 | 36 | 21,50 € |
| 11248 | 36 | 20,00 € |
| 11249 | 36 | 28,00 € |
| 11250 | 36 | 6,50 € |
| 11251 | 36 | 7,50 € |
| 11252 | 36 | 8,50 € |
| 11253 | 36 | 9,00 € |
| 11254 | 36 | 10,00 € |
| 11255 | 36 | 11,50 € |
| 11256 | 36 | 12,50 € |
| 11257 | 36 | 13,00 € |
| 11258 | 36 | 11,50 € |
| 11259 | 36 | 12,50 € |

| REF. | pag. | € |
|-------|------|----------|
| 11260 | 36 | 14,00 € |
| 11261 | 36 | 15,00 € |
| 11262 | 36 | 15,50 € |
| 11313 | 67 | 46,50 € |
| 11314 | 109 | 7,50 € |
| 11315 | 109 | 7,50 € |
| 11316 | 109 | 8,00 € |
| 11318 | 263 | 3,00 € |
| 11320 | 193 | 14,00 € |
| 11321 | 193 | 20,50 € |
| 11323 | 203 | 18,00 € |
| 11324 | 85 | 19,50 € |
| 11325 | 85 | 19,50 € |
| 11329 | 211 | 399,50 € |
| 11374 | 130 | 5,50 € |
| 11375 | 130 | 5,50 € |
| 11376 | 130 | 5,50 € |
| 11377 | 130 | 5,50 € |
| 11378 | 130 | 5,50 € |
| 11379 | 130 | 5,50 € |
| 11380 | 130 | 5,50 € |
| 11381 | 130 | 5,50 € |
| 11382 | 130 | 5,50 € |
| 11383 | 130 | 5,50 € |
| 11384 | 130 | 5,50 € |
| 11385 | 130 | 5,50 € |
| 11386 | 130 | 5,50 € |
| 11387 | 130 | 5,50 € |
| 11388 | 130 | 5,50 € |
| 11389 | 130 | 5,50 € |
| 11390 | 130 | 5,50 € |
| 11391 | 130 | 5,50 € |
| 11392 | 130 | 5,50 € |
| 11393 | 130 | 5,50 € |
| 11394 | 130 | 5,50 € |
| 11492 | 147 | 40,50 € |
| 11493 | 147 | 43,00 € |
| 11494 | 147 | 47,00 € |
| 11541 | 117 | 6,00 € |
| 11542 | 117 | 6,00 € |
| 11543 | 117 | 6,00 € |
| 11544 | 117 | 5,50 € |
| 11545 | 117 | 5,50 € |
| 11546 | 117 | 5,50 € |
| 11547 | 117 | 5,50 € |
| 11613 | 113 | 7,50 € |
| 11614 | 113 | 9,50 € |
| 11615 | 113 | 10,00 € |
| 11616 | 113 | 12,50 € |
| 11617 | 113 | 13,00 € |

| REF. | pag. | € |
|-------|------|----------|
| 11618 | 113 | 13,50 € |
| 11619 | 113 | 14,00 € |
| 11621 | 113 | 244,50 € |
| 11622 | 113 | 308,00 € |
| 11623 | 113 | 333,50 € |
| 11624 | 113 | 132,00 € |
| 11625 | 113 | 211,50 € |
| 11628 | 109 | 8,00 € |
| 11867 | 196 | 10,00 € |
| 11877 | 81 | 77,00 € |
| 11878 | 162 | 5,00 € |
| 11879 | 162 | 5,50 € |
| 11880 | 162 | 10,00 € |
| 11890 | 240 | 0,59 € |
| 11891 | 240 | 0,46 € |
| 11892 | 204 | 11,00 € |
| 11893 | 138 | 7,50 € |
| 11894 | 138 | 8,00 € |
| 11895 | 138 | 8,50 € |
| 11896 | 138 | 10,00 € |
| 11900 | 236 | 3,50 € |
| 11901 | 236 | 2,00 € |
| 11902 | 236 | 2,00 € |
| 11903 | 236 | 5,50 € |
| 11904 | 236 | 2,00 € |
| 11905 | 236 | 2,00 € |
| 11906 | 236 | 7,00 € |
| 11907 | 236 | 12,50 € |
| 11922 | 239 | 5,50 € |
| 11930 | 214 | 321,50 € |
| 11936 | 132 | 4,50 € |
| 11937 | 132 | 5,50 € |
| 11938 | 112 | 43,00 € |
| 11939 | 199 | 53,00 € |
| 11940 | 200 | 41,50 € |
| 11945 | 47 | 6,00 € |
| 11946 | 47 | 3,50 € |
| 11947 | 47 | 6,50 € |
| 11950 | 205 | 20,00 € |
| 11956 | 99 | 5,00 € |
| 11957 | 99 | 5,00 € |
| 11959 | 124 | 3,50 € |
| 11960 | 236 | 2,00 € |
| 11962 | 112 | 7,00 € |
| 11963 | 112 | 8,00 € |
| 11964 | 112 | 10,00 € |
| 11965 | 112 | 13,50 € |
| 11966 | 112 | 15,50 € |
| 11967 | 112 | 15,50 € |
| 11974 | 213 | 1,50 € |

| REF. | pag. | € |
|-------|---------|----------|
| 11975 | 213 | 1,50 € |
| 11976 | 213 | 1,50 € |
| 11977 | 213 | 1,50 € |
| 11978 | 213 | 1,50 € |
| 11979 | 213 | 1,50 € |
| 11980 | 213 | 1,50 € |
| 11981 | 213 | 1,50 € |
| 11982 | 213 | 1,50 € |
| 11983 | 213 | 1,50 € |
| 11989 | 78 | 4,50 € |
| 11990 | 112 | 15,50 € |
| 11992 | 211 | 66,00 € |
| 11993 | 65 | 78,50 € |
| 11994 | 65 | 34,00 € |
| 11995 | 65 | 56,50 € |
| 11996 | 66 | 46,00 € |
| 11997 | 66 | 36,50 € |
| 11998 | 66 | 51,00 € |
| 12002 | 66 | 27,00 € |
| 12003 | 66 | 43,50 € |
| 12004 | 66 | 21,50 € |
| 12005 | 66 | 22,50 € |
| 12006 | 66 | 23,50 € |
| 12007 | 66 | 24,00 € |
| 12009 | 100 | 8,50 € |
| 12022 | 206 | 37,50 € |
| 12029 | 27 | 3,50 € |
| 12030 | 27 | 6,50 € |
| 12032 | 203 | 8,50 € |
| 12044 | 195 | 148,50 € |
| 12046 | 202 | 301,50 € |
| 12055 | 220 | 14,50 € |
| 12056 | 194 | 49,00 € |
| 12060 | 42 | 2,00 € |
| 12061 | 113 | 6,00 € |
| 12062 | 113 | 6,00 € |
| 12063 | 113 | 6,00 € |
| 12064 | 113 | 6,50 € |
| 12065 | 113 | 6,50 € |
| 12066 | 109/113 | 6,50 € |
| 12067 | 113 | 7,00 € |
| 12068 | 109/113 | 7,00 € |
| 12069 | 109/113 | 7,00 € |
| 12070 | 113 | 7,00 € |
| 12071 | 113 | 7,00 € |
| 12072 | 113 | 8,00 € |
| 12074 | 110 | 7,50 € |
| 12075 | 110 | 11,00 € |
| 12901 | 136 | 6,00 € |
| 12902 | 235 | 6,50 € |

| REF. | pag. | € |
|-------|------|---------|
| 12903 | 235 | 6,50 € |
| 12904 | 235 | 6,50 € |
| 12905 | 235 | 6,50 € |
| 12906 | 235 | 6,50 € |
| 12907 | 235 | 6,50 € |
| 12908 | 235 | 6,50 € |
| 12909 | 235 | 6,50 € |
| 12910 | 235 | 6,50 € |
| 12911 | 235 | 6,50 € |
| 12912 | 235 | 6,50 € |
| 12913 | 235 | 6,50 € |
| 12914 | 235 | 11,00 € |
| 12915 | 235 | 17,50 € |
| 12916 | 235 | 7,50 € |
| 12917 | 235 | 11,00 € |
| 12918 | 235 | 11,00 € |
| 12919 | 235 | 11,00 € |
| 12920 | 235 | 11,00 € |
| 12921 | 235 | 11,00 € |
| 12922 | 235 | 11,00 € |
| 12923 | 235 | 11,00 € |
| 12924 | 235 | 6,50 € |
| 12925 | 235 | 11,00 € |
| 12926 | 150 | 19,50 € |
| 12927 | 150 | 20,50 € |
| 12928 | 150 | 21,50 € |
| 12929 | 150 | 23,00 € |
| 12930 | 150 | 24,50 € |
| 12937 | 110 | 6,50 € |
| 12939 | 111 | 6,50 € |
| 12940 | 111 | 6,50 € |
| 12941 | 111 | 6,50 € |
| 12942 | 111 | 6,50 € |
| 12943 | 111 | 6,50 € |
| 12944 | 111 | 7,00 € |
| 12945 | 111 | 7,00 € |
| 12948 | 235 | 25,00 € |
| 12949 | 235 | 25,00 € |
| 12954 | 255 | 0,14 € |
| 12955 | 117 | 31,00 € |
| 12956 | 117 | 31,00 € |
| 12957 | 117 | 31,00 € |
| 12958 | 117 | 31,00 € |
| 12959 | 117 | 31,00 € |
| 12960 | 117 | 31,00 € |
| 12961 | 117 | 31,00 € |
| 12962 | 101 | 3,00 € |
| 12964 | 49 | 2,00 € |
| 12965 | 49 | 2,00 € |
| 12973 | 237 | 0,64 € |

| REF. | pag. | € |
|-------|------|----------|
| 12974 | 129 | 23,50 € |
| 12975 | 129 | 25,50 € |
| 12977 | 157 | 32,00 € |
| 12984 | 113 | 234,00 € |
| 12987 | 102 | 1,50 € |
| 12988 | 105 | 8,00 € |
| 13001 | 214 | 113,50 € |
| 13002 | 256 | 3,50 € |
| 13003 | 256 | 2,00 € |
| 13004 | 256 | 4,50 € |
| 13005 | 256 | 4,50 € |
| 13006 | 256 | 2,50 € |
| 13007 | 256 | 4,50 € |
| 13008 | 256 | 3,50 € |
| 13009 | 256 | 2,00 € |
| 13010 | 256 | 3,50 € |
| 13011 | 256 | 2,50 € |
| 13012 | 256 | 3,50 € |
| 13013 | 256 | 3,50 € |
| 13014 | 256 | 3,50 € |
| 13015 | 256 | 1,50 € |
| 13016 | 256 | 2,00 € |
| 13017 | 256 | 7,00 € |
| 13018 | 256 | 7,00 € |
| 13019 | 256 | 4,50 € |
| 13020 | 256 | 2,50 € |
| 13021 | 256 | 2,50 € |
| 13022 | 256 | 3,00 € |
| 13023 | 256 | 3,00 € |
| 13024 | 256 | 5,50 € |
| 13025 | 256 | 2,50 € |
| 13026 | 259 | 2,50 € |
| 13027 | 259 | 3,50 € |
| 13028 | 259 | 2,00 € |
| 13029 | 259 | 2,00 € |
| 13030 | 259 | 8,00 € |
| 13031 | 259 | 1,50 € |
| 13032 | 259 | 5,00 € |
| 13033 | 259 | 3,50 € |
| 13034 | 259 | 6,50 € |
| 13035 | 259 | 2,00 € |
| 13036 | 259 | 2,00 € |
| 13037 | 259 | 4,00 € |
| 13038 | 257 | 0,84 € |
| 13039 | 257 | 4,50 € |
| 13040 | 257 | 3,50 € |
| 13041 | 257 | 2,50 € |
| 13042 | 257 | 6,50 € |
| 13043 | 257 | 1,50 € |
| 13044 | 257 | 3,00 € |

| REF. | pag. | € | REF. | pag. | € | REF. | pag. | € | REF. | pag. | € |
|-------|------|---------|-------|------|---------|-------|------|----------|-------|------|----------|
| 13045 | 257 | 2,50 € | 13095 | 259 | 2,00 € | 13145 | 257 | 5,50 € | 13474 | 33 | 10,50 € |
| 13046 | 257 | 3,00 € | 13096 | 259 | 2,50 € | 13146 | 257 | 4,00 € | 13475 | 33 | 11,00 € |
| 13047 | 257 | 2,50 € | 13097 | 259 | 0,88 € | 13147 | 257 | 5,50 € | 13476 | 33 | 12,00 € |
| 13048 | 257 | 4,50 € | 13098 | 259 | 1,50 € | 13148 | 257 | 5,50 € | 13477 | 33 | 13,00 € |
| 13049 | 257 | 4,50 € | 13099 | 259 | 9,00 € | 13149 | 257 | 5,50 € | 13478 | 33 | 14,00 € |
| 13050 | 258 | 2,50 € | 13100 | 259 | 0,88 € | 13150 | 257 | 6,50 € | 13479 | 33 | 15,00 € |
| 13051 | 258 | 5,50 € | 13101 | 259 | 2,50 € | 13151 | 257 | 10,50 € | 13480 | 33 | 16,00 € |
| 13052 | 258 | 3,50 € | 13102 | 259 | 1,50 € | 13152 | 257 | 5,50 € | 13481 | 33 | 17,00 € |
| 13053 | 258 | 10,50 € | 13103 | 259 | 3,00 € | 13153 | 257 | 6,50 € | 13482 | 33 | 25,50 € |
| 13054 | 258 | 5,50 € | 13104 | 256 | 2,50 € | 13154 | 257 | 4,50 € | 13483 | 33 | 30,00 € |
| 13055 | 258 | 3,50 € | 13105 | 256 | 4,00 € | 13155 | 257 | 8,50 € | 13484 | 33 | 38,50 € |
| 13056 | 257 | 2,50 € | 13106 | 256 | 2,50 € | 13156 | 257 | 8,50 € | 13485 | 32 | 9,50 € |
| 13057 | 257 | 1,50 € | 13107 | 256 | 2,50 € | 13157 | 257 | 8,50 € | 13486 | 32 | 10,50 € |
| 13058 | 257 | 5,50 € | 13108 | 256 | 5,50 € | 13158 | 257 | 5,50 € | 13487 | 32 | 12,00 € |
| 13059 | 257 | 5,50 € | 13109 | 256 | 8,00 € | 13159 | 257 | 4,50 € | 13488 | 32 | 13,50 € |
| 13060 | 257 | 1,50 € | 13110 | 256 | 4,00 € | 13160 | 257 | 8,50 € | 13489 | 32 | 16,00 € |
| 13061 | 257 | 5,50 € | 13111 | 256 | 3,00 € | 13161 | 257 | 6,50 € | 13490 | 32 | 17,00 € |
| 13062 | 257 | 5,50 € | 13112 | 256 | 2,00 € | 13162 | 257 | 4,50 € | 13491 | 32 | 5,00 € |
| 13063 | 257 | 2,00 € | 13113 | 256 | 5,50 € | 13163 | 257 | 4,50 € | 13492 | 32 | 5,00 € |
| 13064 | 257 | 5,50 € | 13114 | 256 | 5,50 € | 13234 | 195 | 186,50 € | 13493 | 32 | 5,00 € |
| 13065 | 257 | 4,00 € | 13115 | 256 | 8,00 € | 13242 | 265 | 14,00 € | 13494 | 32 | 5,50 € |
| 13066 | 257 | 1,50 € | 13116 | 259 | 13,00 € | 13243 | 265 | 14,00 € | 13495 | 32 | 6,00 € |
| 13067 | 257 | 7,00 € | 13117 | 259 | 13,00 € | 13244 | 265 | 14,00 € | 13496 | 32 | 6,50 € |
| 13068 | 258 | 9,00 € | 13118 | 259 | 15,50 € | 13245 | 265 | 14,00 € | 13497 | 32 | 7,00 € |
| 13069 | 258 | 11,00 € | 13119 | 259 | 4,00 € | 13306 | 193 | 34,00 € | 13498 | 32 | 8,00 € |
| 13070 | 258 | 4,00 € | 13120 | 259 | 15,50 € | 13307 | 193 | 13,00 € | 13499 | 100 | 10,00 € |
| 13071 | 258 | 4,00 € | 13121 | 259 | 16,50 € | 13447 | 33 | 19,00 € | 13500 | 100 | 10,00 € |
| 13072 | 258 | 5,50 € | 13122 | 259 | 4,50 € | 13448 | 33 | 20,00 € | 13667 | 65 | 16,50 € |
| 13073 | 258 | 2,00 € | 13123 | 259 | 8,50 € | 13449 | 33 | 23,50 € | 13668 | 65 | 17,50 € |
| 13074 | 258 | 13,50 € | 13124 | 259 | 11,50 € | 13450 | 33 | 26,50 € | 13669 | 65 | 16,50 € |
| 13075 | 258 | 9,00 € | 13125 | 259 | 10,50 € | 13451 | 33 | 32,50 € | 13670 | 66 | 20,00 € |
| 13076 | 258 | 7,00 € | 13126 | 259 | 10,50 € | 13452 | 33 | 33,50 € | 13672 | 203 | 242,00 € |
| 13077 | 258 | 2,00 € | 13127 | 259 | 8,50 € | 13453 | 32 | 10,00 € | 13674 | 44 | 0,40 € |
| 13078 | 258 | 3,00 € | 13128 | 256 | 9,50 € | 13454 | 32 | 10,50 € | 13675 | 44 | 0,40 € |
| 13079 | 258 | 9,00 € | 13129 | 256 | 4,00 € | 13455 | 32 | 11,00 € | 13676 | 44 | 0,40 € |
| 13080 | 258 | 4,50 € | 13130 | 256 | 4,00 € | 13456 | 32 | 12,50 € | 13677 | 44 | 0,40 € |
| 13081 | 258 | 6,00 € | 13131 | 256 | 4,00 € | 13457 | 32 | 13,50 € | 13678 | 44 | 0,40 € |
| 13082 | 258 | 3,00 € | 13132 | 256 | 5,00 € | 13460 | 32 | 16,50 € | 13679 | 147 | 6,50 € |
| 13083 | 258 | 2,00 € | 13133 | 256 | 7,00 € | 13462 | 32 | 18,00 € | 13680 | 110 | 13,50 € |
| 13084 | 258 | 6,00 € | 13134 | 256 | 6,00 € | 13463 | 33 | 6,50 € | 13681 | 110 | 13,50 € |
| 13085 | 258 | 1,50 € | 13135 | 256 | 7,00 € | 13464 | 33 | 6,50 € | 13682 | 110 | 13,50 € |
| 13086 | 258 | 1,50 € | 13136 | 256 | 3,00 € | 13465 | 33 | 6,50 € | 13683 | 110 | 13,50 € |
| 13087 | 258 | 7,50 € | 13137 | 256 | 5,00 € | 13466 | 33 | 7,00 € | 13684 | 110 | 14,00 € |
| 13088 | 258 | 3,00 € | 13138 | 256 | 6,00 € | 13467 | 33 | 7,00 € | 13685 | 110 | 14,00 € |
| 13089 | 258 | 3,00 € | 13139 | 256 | 7,50 € | 13468 | 33 | 7,00 € | 13686 | 110 | 14,00 € |
| 13090 | 258 | 2,50 € | 13140 | 257 | 6,50 € | 13469 | 33 | 7,50 € | 13687 | 110 | 15,00 € |
| 13091 | 258 | 1,50 € | 13141 | 257 | 4,50 € | 13470 | 33 | 8,50 € | 13688 | 110 | 15,00 € |
| 13092 | 259 | 4,50 € | 13142 | 257 | 5,50 € | 13471 | 33 | 9,00 € | 13689 | 110 | 15,00 € |
| 13093 | 259 | 9,00 € | 13143 | 257 | 2,00 € | 13472 | 33 | 9,50 € | 13704 | 154 | 18,00 € |
| 13094 | 259 | 3,00 € | 13144 | 257 | 5,50 € | 13473 | 33 | 10,00 € | 13707 | 53 | 9,00 € |

* I prezzi al dettaglio. Tasse non incluse.



WWW.JBMCAMP.COM

JBM
2019

271

| REF. | pag. | € |
|-------|--------|---------|
| 13708 | 53 | 9,00 € |
| 13709 | 53 | 9,00 € |
| 13710 | 53 | 10,00 € |
| 13712 | 53 | 10,50 € |
| 13723 | 113 | 12,00 € |
| 13724 | 113 | 12,00 € |
| 13725 | 113 | 12,50 € |
| 13726 | 113 | 12,50 € |
| 13727 | 113 | 13,00 € |
| 13728 | 113 | 13,00 € |
| 13729 | 113 | 14,00 € |
| 13730 | 113 | 14,00 € |
| 13731 | 113 | 14,50 € |
| 13732 | 113 | 15,50 € |
| 13733 | 113 | 16,00 € |
| 13734 | 113 | 16,50 € |
| 13735 | 113 | 16,50 € |
| 13736 | 113 | 17,00 € |
| 13738 | 239 | 3,50 € |
| 13739 | 239 | 5,50 € |
| 13741 | 239 | 23,50 € |
| 13745 | 113 | 17,50 € |
| 13746 | 113 | 17,50 € |
| 13747 | 113 | 17,50 € |
| 13748 | 113 | 18,00 € |
| 13803 | 220 | 8,00 € |
| 13805 | 237 | 11,00 € |
| 13806 | 237 | 11,00 € |
| 13809 | 105 | 10,00 € |
| 13810 | 105 | 11,50 € |
| 13813 | 119 | 5,50 € |
| 13814 | 119 | 8,00 € |
| 13815 | 229 | 6,50 € |
| 13816 | 77/215 | 0,70 € |
| 13817 | 99 | 15,50 € |
| 13818 | 99 | 19,00 € |
| 13819 | 248 | 6,00 € |
| 13820 | 248 | 6,50 € |
| 13821 | 248 | 12,50 € |
| 13822 | 248 | 10,00 € |
| 13823 | 248 | 5,00 € |
| 13824 | 248 | 7,50 € |
| 13825 | 248 | 9,50 € |
| 13826 | 248 | 12,00 € |
| 13827 | 248 | 14,50 € |
| 13828 | 248 | 10,50 € |
| 13829 | 248 | 9,00 € |
| 13830 | 248 | 10,00 € |
| 13831 | 248 | 11,50 € |
| 13832 | 248 | 12,00 € |

| REF. | pag. | € |
|-------|--------|----------|
| 13833 | 248 | 8,00 € |
| 13836 | 199 | 8,00 € |
| 13839 | 78/215 | 7,00 € |
| 13842 | 117 | 5,50 € |
| 13843 | 117 | 4,00 € |
| 13844 | 117 | 7,50 € |
| 13845 | 117 | 5,50 € |
| 13853 | 199 | 102,50 € |
| 13855 | 229 | 7,00 € |
| 13856 | 131 | 9,00 € |
| 13874 | 112 | 13,00 € |
| 13875 | 112 | 14,00 € |
| 13876 | 112 | 14,00 € |
| 13877 | 112 | 14,00 € |
| 13879 | 240 | - |
| 13880 | 240 | - |
| 13884 | 66 | 9,00 € |
| 13922 | 65 | 63,00 € |
| 13923 | 66 | 7,50 € |
| 13925 | 193 | 6,50 € |
| 13926 | 193 | 118,50 € |
| 13930 | 105 | 1,50 € |
| 13931 | 105 | 2,00 € |
| 13932 | 105 | 1,50 € |
| 13933 | 105 | 1,50 € |
| 13934 | 105 | 2,00 € |
| 13935 | 105 | 2,00 € |
| 13936 | 105 | 3,50 € |
| 13937 | 105 | 4,00 € |
| 13938 | 105 | 3,50 € |
| 13939 | 105 | 4,00 € |
| 13940 | 66 | 16,00 € |
| 13941 | 66 | 20,50 € |
| 13942 | 66 | 34,00 € |
| 13943 | 66 | 32,50 € |
| 13944 | 65 | 21,50 € |
| 13945 | 249 | 6,00 € |
| 13946 | 249 | 8,00 € |
| 13947 | 249 | 7,50 € |
| 13948 | 249 | 6,50 € |
| 13949 | 249 | 8,50 € |
| 13950 | 249 | 9,50 € |
| 13951 | 249 | 6,50 € |
| 13952 | 249 | 11,00 € |
| 13953 | 249 | 9,00 € |
| 13954 | 249 | 11,00 € |
| 13955 | 249 | 6,50 € |
| 13956 | 249 | 5,50 € |
| 13957 | 249 | 8,50 € |
| 13958 | 249 | 6,50 € |

| REF. | pag. | € |
|-------|--------|----------|
| 13959 | 249 | 11,00 € |
| 13960 | 249 | 5,00 € |
| 13961 | 249 | 11,00 € |
| 13962 | 249 | 2,50 € |
| 13963 | 249 | 15,00 € |
| 13964 | 249 | 16,50 € |
| 13965 | 249 | 2,00 € |
| 13966 | 249 | 17,00 € |
| 13967 | 249 | 6,50 € |
| 13968 | 264 | 3,50 € |
| 13969 | 133 | 15,00 € |
| 13982 | 195 | 2,50 € |
| 14004 | 111 | 8,50 € |
| 14005 | 111 | 8,50 € |
| 14006 | 111 | 8,50 € |
| 14007 | 111 | 8,50 € |
| 14008 | 111 | 8,50 € |
| 14009 | 111 | 8,50 € |
| 14010 | 111 | 9,00 € |
| 14011 | 111 | 9,50 € |
| 14013 | 99 | 0,70 € |
| 14014 | 193 | 5,00 € |
| 14015 | 193 | 5,00 € |
| 14016 | 193 | 5,50 € |
| 14031 | 78 | 6,50 € |
| 14032 | 78 | 5,00 € |
| 14033 | 78 | 2,50 € |
| 14034 | 263 | 7,50 € |
| 14049 | 55 | 5,50 € |
| 14050 | 55 | 7,00 € |
| 14051 | 55 | 10,00 € |
| 14052 | 55 | 12,00 € |
| 14068 | 200 | 6,00 € |
| 14069 | 200 | 9,50 € |
| 14070 | 200 | 99,50 € |
| 14071 | 199 | 9,50 € |
| 14072 | 199 | 17,50 € |
| 14073 | 199 | 111,00 € |
| 14075 | 105 | 1,00 € |
| 14076 | 105 | 1,00 € |
| 14077 | 105 | 3,50 € |
| 14078 | 105 | 3,50 € |
| 14080 | 83 | 10,00 € |
| 14081 | 211 | 13,50 € |
| 14090 | 203 | 99,50 € |
| 14092 | 97/212 | 147,50 € |
| 14103 | 121 | 30,00 € |
| 14104 | 121 | 30,00 € |
| 14105 | 121 | 30,00 € |
| 14106 | 121 | 30,00 € |

| REF. | pag. | € |
|-------|------|----------|
| 14107 | 121 | 30,00 € |
| 14108 | 121 | 30,00 € |
| 14109 | 211 | 32,00 € |
| 14110 | 211 | 121,00 € |
| 50400 | 125 | 152,00 € |
| 50403 | 125 | 92,50 € |
| 50409 | 125 | 26,50 € |
| 50410 | 125 | 152,00 € |
| 50431 | 90 | 3,50 € |
| 50437 | 9 | 70,50 € |
| 50508 | 28 | 3,50 € |
| 50515 | 81 | 15,50 € |
| 50517 | 218 | 75,00 € |
| 50518 | 218 | 109,00 € |
| 50521 | 8 | 76,00 € |
| 50523 | 90 | 5,00 € |
| 50524 | 90 | 5,00 € |
| 50525 | 229 | 0,97 € |
| 50526 | 229 | 4,00 € |
| 50551 | 90 | 275,00 € |
| 50560 | 34 | 33,00 € |
| 50561 | 35 | 13,50 € |
| 50562 | 35 | 18,50 € |
| 50563 | 35 | 24,50 € |
| 50564 | 35 | 20,00 € |
| 50566 | 12 | 33,00 € |
| 50567 | 52 | 11,00 € |
| 50571 | 37 | 6,50 € |
| 50577 | 120 | 10,00 € |
| 50580 | 52 | 11,00 € |
| 50585 | 231 | 11,00 € |
| 50600 | 233 | 0,73 € |
| 50601 | 233 | 0,22 € |
| 50622 | 34 | 47,50 € |
| 50623 | 18 | 54,00 € |
| 50630 | 205 | 407,00 € |
| 50631 | 203 | 66,00 € |
| 50632 | 213 | 231,00 € |
| 50644 | 227 | 13,00 € |
| 50651 | 251 | 15,50 € |
| 50652 | 251 | 15,50 € |
| 50654 | 226 | 3,50 € |
| 50656 | 219 | 218,00 € |
| 50717 | 227 | 23,50 € |
| 50724 | 154 | 24,50 € |
| 50731 | 217 | 108,00 € |
| 50751 | 196 | 32,50 € |
| 50754 | 33 | 65,00 € |
| 50760 | 233 | 0,10 € |
| 50761 | 233 | 0,13 € |

| REF. | pag. | € | REF. | pag. | € | REF. | pag. | € | REF. | pag. | € |
|-------|------|----------|-------|---------|----------|-------|------|------------|-------|---------|----------|
| 50762 | 233 | 0,22 € | 50830 | 202 | 439,00 € | 51051 | 221 | 29,00 € | 51261 | 19 | 32,00 € |
| 50763 | 233 | 0,28 € | 50831 | 203 | 324,50 € | 51055 | 233 | 0,70 € | 51262 | 153 | 44,00 € |
| 50764 | 233 | 0,34 € | 50832 | 201 | 36,50 € | 51056 | 233 | 0,70 € | 51266 | 227 | 30,50 € |
| 50765 | 233 | 0,40 € | 50833 | 201 | 86,00 € | 51058 | 194 | 547,00 € | 51270 | 45 | 15,50 € |
| 50766 | 233 | 0,47 € | 50835 | 203 | 299,50 € | 51059 | 128 | 90,50 € | 51272 | 48 | 7,50 € |
| 50767 | 233 | 0,56 € | 50836 | 203 | 108,00 € | 51118 | 214 | 3.278,00 € | 51277 | 104 | 43,00 € |
| 50768 | 233 | 0,59 € | 50838 | 203 | 214,50 € | 51119 | 136 | 62,50 € | 51283 | 128 | 70,50 € |
| 50769 | 233 | 0,10 € | 50839 | 206 | 214,50 € | 51120 | 160 | 42,00 € | 51285 | 45 | 12,50 € |
| 50770 | 233 | 0,14 € | 50840 | 204 | 125,50 € | 51121 | 160 | 26,50 € | 51286 | 45 | 12,50 € |
| 50771 | 233 | 0,21 € | 50843 | 74 | 59,50 € | 51122 | 147 | 155,50 € | 51287 | 45 | 14,50 € |
| 50772 | 233 | 0,28 € | 50844 | 74 | 46,50 € | 51123 | 146 | 137,50 € | 51288 | 263 | 467,50 € |
| 50773 | 233 | 0,33 € | 50852 | 196 | 24,50 € | 51124 | 147 | 178,50 € | 51289 | 263 | 55,50 € |
| 50774 | 233 | 0,43 € | 50889 | 35 | 65,00 € | 51125 | 147 | 65,00 € | 51299 | 106/217 | 108,00 € |
| 50775 | 233 | 0,48 € | 50895 | 6 | 145,50 € | 51126 | 149 | 21,00 € | 51305 | 46 | 18,00 € |
| 50776 | 233 | 0,51 € | 50896 | 34 | 49,50 € | 51127 | 153 | 46,50 € | 51306 | 46 | 15,50 € |
| 50777 | 233 | 0,58 € | 50901 | 119 | 19,00 € | 51131 | 117 | 52,50 € | 51307 | 46 | 33,00 € |
| 50778 | 233 | 0,10 € | 50902 | 39 | 13,00 € | 51132 | 197 | 21,00 € | 51315 | 263 | 3,00 € |
| 50779 | 233 | 0,13 € | 50903 | 119 | 26,50 € | 51135 | 190 | 70,50 € | 51316 | 10 | 65,00 € |
| 50780 | 233 | 0,21 € | 50905 | 241 | 172,00 € | 51138 | 151 | 179,00 € | 51318 | 32 | 98,00 € |
| 50781 | 233 | 0,28 € | 50910 | 89 | 43,00 € | 51139 | 144 | 183,00 € | 51323 | 205 | 54,00 € |
| 50782 | 233 | 0,33 € | 50911 | 205 | 814,00 € | 51140 | 151 | 69,00 € | 51325 | 80 | 3,00 € |
| 50783 | 233 | 0,40 € | 50913 | 219 | 106,00 € | 51206 | 93 | 229,00 € | 51326 | 80 | 6,00 € |
| 50784 | 233 | 0,48 € | 50915 | 90 | 4,50 € | 51207 | 94 | 286,00 € | 51331 | 80 | 0,50 € |
| 50785 | 233 | 0,56 € | 50916 | 125 | 1,00 € | 51210 | 94 | 658,00 € | 51332 | 130 | 108,00 € |
| 50786 | 233 | 0,65 € | 50917 | 194 | 279,50 € | 51211 | 94 | 572,00 € | 51333 | 28 | 15,50 € |
| 50787 | 165 | 5,50 € | 50918 | 194 | 292,50 € | 51212 | 94 | 539,00 € | 51336 | 109 | 27,00 € |
| 50788 | 165 | 11,00 € | 50923 | 206 | 247,50 € | 51213 | 94 | 691,00 € | 51337 | 133 | 75,00 € |
| 50789 | 165 | 19,00 € | 50924 | 193 | 219,00 € | 51214 | 96 | 141,00 € | 51338 | 153 | 45,50 € |
| 50790 | 165 | 24,50 € | 50935 | 194 | 544,50 € | 51215 | 96 | 109,00 € | 51339 | 157 | 284,00 € |
| 50791 | 7 | 81,50 € | 50937 | 154 | 10,50 € | 51216 | 97 | 572,00 € | 51340 | 188 | 39,50 € |
| 50792 | 137 | 119,00 € | 50938 | 234 | 158,50 € | 51218 | 96 | 262,00 € | 51341 | 102/165 | 33,00 € |
| 50793 | 137 | 81,50 € | 50942 | 210 | 26,50 € | 51219 | 96 | 214,50 € | 51347 | 163 | 10,00 € |
| 50797 | 196 | 427,00 € | 50957 | 221 | 19,50 € | 51220 | 95 | 214,50 € | 51348 | 188 | 38,00 € |
| 50807 | 251 | 33,50 € | 50958 | 221 | 33,00 € | 51221 | 95 | 200,50 € | 51349 | 150 | 30,50 € |
| 50808 | 74 | 53,00 € | 50959 | 221/247 | 12,50 € | 51222 | 93 | 109,00 € | 51352 | 131 | 8,00 € |
| 50811 | 217 | 130,50 € | 50960 | 221 | 17,00 € | 51225 | 95 | 209,00 € | 51353 | 131 | 10,00 € |
| 50812 | 202 | 319,00 € | 50961 | 221 | 90,50 € | 51226 | 96 | 214,50 € | 51354 | 131 | 12,00 € |
| 50813 | 202 | 439,00 € | 50966 | 226 | 3,00 € | 51227 | 96 | 186,50 € | 51355 | 55/233 | 16,50 € |
| 50814 | 202 | 748,00 € | 50980 | 27 | 21,00 € | 51230 | 81 | 105,00 € | 51356 | 196 | 42,00 € |
| 50815 | 199 | 53,00 € | 50982 | 27 | 21,00 € | 51231 | 151 | 179,00 € | 51358 | 237 | 8,50 € |
| 50816 | 200 | 65,00 € | 50983 | 21 | 42,00 € | 51232 | 81 | 68,50 € | 51359 | 237 | 9,00 € |
| 50818 | 199 | 172,00 € | 50985 | 21 | 54,00 € | 51235 | 209 | 51,00 € | 51360 | 118 | 6,50 € |
| 50819 | 201 | 20,00 € | 51017 | 51 | 6,50 € | 51238 | 208 | 97,00 € | 51361 | 118 | 11,00 € |
| 50820 | 201 | 24,50 € | 51018 | 51 | 6,50 € | 51239 | 208 | 130,00 € | 51362 | 237 | 3,50 € |
| 50821 | 201 | 34,50 € | 51020 | 51 | 6,50 € | 51245 | 95 | 105,50 € | 51363 | 208 | 75,00 € |
| 50822 | 201 | 46,00 € | 51021 | 51 | 6,50 € | 51246 | 227 | 7,50 € | 51364 | 151 | 31,00 € |
| 50823 | 201 | 74,00 € | 51028 | 112 | 211,50 € | 51253 | 195 | 39,00 € | 51365 | 208 | 86,00 € |
| 50824 | 201 | 71,00 € | 51033 | 215 | 62,00 € | 51258 | 80 | 0,20 € | 51368 | 143 | 37,50 € |
| 50825 | 201 | 111,50 € | 51035 | 69 | 583,00 € | 51259 | 144 | 53,00 € | 51369 | 143 | 35,50 € |
| 50827 | 160 | 301,50 € | 51050 | 221 | 238,50 € | 51260 | 20 | 32,00 € | 51378 | 40/66 | 18,00 € |

* I prezzi al dettaglio. Tasse non incluse.



WWW.JBMCAMP.COM

JBM
2019

273

| REF. | pag. | € |
|-------|-------|------------|
| 51380 | 40/66 | 18,00 € |
| 51381 | 40/66 | 13,50 € |
| 51382 | 45 | 13,50 € |
| 51383 | 104 | 9,50 € |
| 51384 | 20 | 32,00 € |
| 51385 | 102 | 4,50 € |
| 51386 | 102 | 6,00 € |
| 51387 | 102 | 3,00 € |
| 51388 | 97 | 20,00 € |
| 51389 | 97 | 20,00 € |
| 51390 | 97 | 20,00 € |
| 51391 | 97 | 20,00 € |
| 51392 | 97 | 27,50 € |
| 51393 | 97 | 27,50 € |
| 51394 | 97 | 27,50 € |
| 51400 | 133 | 15,00 € |
| 51401 | 133 | 17,00 € |
| 51402 | 133 | 17,50 € |
| 51403 | 133 | 14,50 € |
| 51405 | 46 | 22,50 € |
| 51406 | 46 | 32,50 € |
| 51409 | 20 | 37,50 € |
| 51410 | 20 | 37,50 € |
| 51412 | 230 | 2,00 € |
| 51414 | 143 | 13,50 € |
| 51416 | 238 | 10,00 € |
| 51418 | 69 | 3,00 € |
| 51419 | 69 | 3,50 € |
| 51420 | 69 | 3,50 € |
| 51421 | 69 | 4,00 € |
| 51422 | 69 | 4,00 € |
| 51423 | 69 | 4,50 € |
| 51425 | 68 | 549,00 € |
| 51426 | 68 | 434,50 € |
| 51427 | 63 | 988,00 € |
| 51428 | 71 | 1.089,00 € |
| 51439 | 97 | 27,50 € |
| 51440 | 97 | 27,50 € |
| 51441 | 97 | 27,50 € |
| 51442 | 97 | 27,50 € |
| 51443 | 102 | 5,50 € |
| 51444 | 102 | 5,50 € |
| 51445 | 102 | 5,50 € |
| 51446 | 80 | 3,00 € |
| 51447 | 48 | 13,50 € |
| 51448 | 48 | 53,50 € |
| 51452 | 204 | 34,50 € |
| 51456 | 67 | 544,50 € |
| 51479 | 48 | 28,50 € |
| 51482 | 189 | 64,00 € |

| REF. | pag. | € |
|-------|------|----------|
| 51485 | 189 | 54,00 € |
| 51486 | 189 | 118,50 € |
| 51487 | 189 | 208,00 € |
| 51488 | 189 | 21,00 € |
| 51489 | 188 | 10,00 € |
| 51490 | 146 | 31,00 € |
| 51491 | 136 | 125,50 € |
| 51493 | 136 | 87,00 € |
| 51494 | 134 | 106,00 € |
| 51495 | 141 | 52,50 € |
| 51496 | 142 | 9,00 € |
| 51498 | 134 | 130,00 € |
| 51499 | 134 | 153,00 € |
| 51500 | 144 | 43,00 € |
| 51501 | 145 | 43,00 € |
| 51504 | 41 | 6,00 € |
| 51525 | 48 | 7,50 € |
| 51526 | 48 | 7,50 € |
| 51528 | 36 | 32,00 € |
| 51529 | 35 | 48,50 € |
| 51538 | 249 | 0,10 € |
| 51539 | 249 | 0,12 € |
| 51540 | 249 | 0,13 € |
| 51541 | 249 | 0,13 € |
| 51542 | 249 | 0,15 € |
| 51543 | 249 | 0,18 € |
| 51544 | 249 | 0,21 € |
| 51545 | 249 | 0,29 € |
| 51546 | 249 | 0,21 € |
| 51548 | 241 | 346,50 € |
| 51549 | 241 | 346,50 € |
| 51550 | 241 | 378,50 € |
| 51551 | 241 | 277,50 € |
| 51554 | 249 | 0,31 € |
| 51555 | 241 | 169,50 € |
| 51556 | 241 | 169,50 € |
| 51557 | 241 | 169,50 € |
| 51558 | 241 | 169,50 € |
| 51570 | 73 | 148,50 € |
| 51572 | 73 | 306,00 € |
| 51573 | 80 | 2,50 € |
| 51574 | 71 | 32,00 € |
| 51575 | 71 | 202,50 € |
| 51576 | 68 | 97,00 € |
| 51583 | 241 | 183,00 € |
| 51600 | 71 | 73,00 € |
| 51602 | 214 | 242,00 € |
| 51603 | 214 | 308,00 € |
| 51604 | 233 | 0,70 € |
| 51611 | 40 | 10,00 € |

| REF. | pag. | € |
|-------|--------|----------|
| 51612 | 90 | 6,50 € |
| 51613 | 90 | 3,00 € |
| 51614 | 90 | 3,50 € |
| 51615 | 90 | 6,50 € |
| 51616 | 18 | 361,00 € |
| 51617 | 19 | 60,50 € |
| 51622 | 126 | 15,50 € |
| 51633 | 223 | 1,50 € |
| 51634 | 223 | 1,50 € |
| 51653 | 69 | 8,00 € |
| 51654 | 69 | 4,00 € |
| 51655 | 69 | 4,50 € |
| 51656 | 69 | 4,50 € |
| 51657 | 69 | 9,00 € |
| 51658 | 69 | 4,00 € |
| 51659 | 34 | 62,00 € |
| 51661 | 47/238 | 10,00 € |
| 51674 | 41 | 6,50 € |
| 51675 | 42 | 7,00 € |
| 51680 | 224 | 3,00 € |
| 51688 | 264 | 5,00 € |
| 51691 | 224 | 3,00 € |
| 51692 | 224 | 2,50 € |
| 51693 | 224 | 2,50 € |
| 51694 | 224 | 2,50 € |
| 51696 | 224 | 2,50 € |
| 51697 | 229 | 0,42 € |
| 51703 | 239 | 8,50 € |
| 51705 | 239 | 6,50 € |
| 51706 | 241 | 20,00 € |
| 51707 | 241 | 12,00 € |
| 51708 | 241 | 15,50 € |
| 51709 | 241 | 18,50 € |
| 51710 | 241 | 23,00 € |
| 51711 | 241 | 26,50 € |
| 51712 | 241 | 13,50 € |
| 51713 | 241 | 16,50 € |
| 51714 | 241 | 22,00 € |
| 51715 | 241 | 25,50 € |
| 51716 | 241 | 31,00 € |
| 51717 | 241 | 15,50 € |
| 51718 | 241 | 19,00 € |
| 51719 | 241 | 25,50 € |
| 51720 | 241 | 28,50 € |
| 51721 | 241 | 32,00 € |
| 51722 | 241 | 18,00 € |
| 51723 | 241 | 22,00 € |
| 51724 | 241 | 27,50 € |
| 51725 | 241 | 35,50 € |
| 51726 | 241 | 35,50 € |

| REF. | pag. | € |
|-------|--------|----------|
| 51727 | 241 | 44,00 € |
| 51737 | 70 | 469,00 € |
| 51738 | 70 | 544,50 € |
| 51741 | 237 | 0,35 € |
| 51742 | 237 | 0,43 € |
| 51743 | 237 | 0,56 € |
| 51745 | 223 | 0,53 € |
| 51746 | 27 | 10,00 € |
| 51747 | 36 | 23,50 € |
| 51750 | 205 | 242,00 € |
| 51751 | 204 | 65,00 € |
| 51785 | 223 | 0,57 € |
| 51794 | 40 | 5,00 € |
| 51795 | 40 | 7,50 € |
| 51796 | 40 | 10,00 € |
| 51797 | 40 | 13,50 € |
| 51798 | 40 | 28,00 € |
| 51799 | 249 | 0,21 € |
| 51801 | 47 | 63,00 € |
| 51802 | 28 | 16,00 € |
| 51804 | 247 | 52,00 € |
| 51805 | 48 | 16,50 € |
| 51812 | 50 | 32,00 € |
| 51814 | 229 | 9,00 € |
| 51816 | 209 | 54,00 € |
| 51817 | 226 | 4,00 € |
| 51818 | 16 | 86,00 € |
| 51819 | 11 | 51,00 € |
| 51820 | 11 | 51,00 € |
| 51822 | 159 | 136,50 € |
| 51824 | 125 | 32,00 € |
| 51828 | 153 | 488,50 € |
| 51829 | 153 | 429,50 € |
| 51830 | 153 | 84,50 € |
| 51831 | 211 | 15,50 € |
| 51832 | 119 | 21,50 € |
| 51837 | 212 | 193,00 € |
| 51838 | 212 | 658,00 € |
| 51839 | 211 | 31,00 € |
| 51840 | 33 | 324,50 € |
| 51841 | 188 | 76,50 € |
| 51842 | 209 | 8,00 € |
| 51843 | 249 | 0,21 € |
| 51853 | 43 | 15,50 € |
| 51855 | 18 | 361,00 € |
| 51858 | 228 | 13,00 € |
| 51859 | 211 | 4,50 € |
| 51861 | 96/239 | 163,00 € |
| 51863 | 230 | 54,00 € |
| 51864 | 36 | 70,50 € |

| REF. | pag. | € |
|-------|---------|----------|
| 51876 | 197 | 21,00 € |
| 51877 | 28 | 3,50 € |
| 51878 | 36 | 45,50 € |
| 51879 | 36 | 35,00 € |
| 51885 | 23 | 84,00 € |
| 51886 | 89 | 46,50 € |
| 51887 | 40 | 3,00 € |
| 51889 | 77 | 44,00 € |
| 51890 | 23/37 | 87,00 € |
| 51892 | 12 | 33,00 € |
| 51893 | 139 | 438,00 € |
| 51894 | 139 | 438,00 € |
| 51895 | 200 | 64,00 € |
| 51896 | 138 | 121,00 € |
| 51897 | 138 | 121,00 € |
| 51898 | 138 | 109,00 € |
| 51899 | 138 | 109,00 € |
| 51901 | 202 | 605,00 € |
| 51902 | 145 | 65,00 € |
| 51903 | 200 | 139,50 € |
| 51905 | 201 | 23,00 € |
| 51906 | 201 | 29,50 € |
| 51907 | 201 | 37,00 € |
| 51908 | 234 | 43,00 € |
| 51909 | 40 | 3,00 € |
| 51918 | 41 | 10,50 € |
| 51919 | 155 | 64,00 € |
| 51920 | 217/252 | 20,00 € |
| 51921 | 45 | 20,00 € |
| 51923 | 131 | 11,00 € |
| 51925 | 229 | 1,50 € |
| 51927 | 190 | 37,50 € |
| 51928 | 196 | 13,50 € |
| 51929 | 89 | 23,50 € |
| 51930 | 19 | 42,00 € |
| 51934 | 131 | 11,00 € |
| 51935 | 228 | 156,50 € |
| 51936 | 228 | 156,50 € |
| 51937 | 228 | 156,50 € |
| 51939 | 183 | 458,00 € |
| 51940 | 171 | 439,00 € |
| 51941 | 179 | 163,00 € |
| 51942 | 177 | 219,00 € |
| 51943 | 176 | 219,00 € |
| 51944 | 187 | 394,00 € |
| 51951 | 43 | 17,50 € |
| 51952 | 38 | 15,00 € |
| 51953 | 38 | 15,00 € |
| 51954 | 37 | 27,00 € |
| 51955 | 38 | 4,00 € |

| REF. | pag. | € |
|-------|-------|----------|
| 51958 | 155 | 374,00 € |
| 51959 | 37 | 29,00 € |
| 51960 | 84 | 30,00 € |
| 51961 | 84 | 31,00 € |
| 51962 | 83 | 23,50 € |
| 51963 | 83 | 27,50 € |
| 51964 | 83 | 27,00 € |
| 51965 | 83 | 27,00 € |
| 51966 | 84 | 20,00 € |
| 51967 | 85 | 16,00 € |
| 51968 | 85 | 16,00 € |
| 51969 | 85 | 15,50 € |
| 51970 | 23/37 | 11,00 € |
| 51972 | 49 | 12,00 € |
| 51973 | 230 | 43,00 € |
| 51974 | 69 | 2,00 € |
| 51975 | 69 | 2,00 € |
| 51976 | 69 | 2,50 € |
| 51977 | 69 | 3,00 € |
| 51978 | 126 | 62,00 € |
| 51980 | 103 | 14,00 € |
| 51981 | 103 | 20,00 € |
| 51982 | 218 | 109,00 € |
| 51983 | 218 | 189,50 € |
| 51984 | 218 | 203,50 € |
| 51985 | 125 | 79,50 € |
| 51986 | 217 | 11,00 € |
| 51989 | 161 | 45,00 € |
| 51990 | 152 | 94,50 € |
| 51991 | 145 | 43,00 € |
| 51995 | 53 | 25,00 € |
| 51996 | 151 | 13,00 € |
| 51997 | 142 | 49,00 € |
| 51998 | 141 | 89,00 € |
| 51999 | 152 | 83,50 € |
| 52002 | 79 | 29,00 € |
| 52008 | 133 | 40,00 € |
| 52009 | 30 | 36,00 € |
| 52010 | 148 | 53,50 € |
| 52012 | 155 | 67,50 € |
| 52013 | 42 | 10,50 € |
| 52014 | 43 | 13,50 € |
| 52016 | 138 | 2,50 € |
| 52017 | 138 | 3,00 € |
| 52018 | 138 | 3,00 € |
| 52019 | 138 | 4,00 € |
| 52021 | 138 | 4,00 € |
| 52022 | 138 | 5,00 € |
| 52023 | 138 | 7,50 € |
| 52024 | 138 | 12,00 € |

| REF. | pag. | € |
|-------|------|----------|
| 52025 | 138 | 14,50 € |
| 52026 | 119 | 26,50 € |
| 52027 | 243 | 15,50 € |
| 52028 | 245 | 11,00 € |
| 52029 | 245 | 15,50 € |
| 52030 | 250 | 69,50 € |
| 52031 | 248 | 44,00 € |
| 52032 | 248 | 29,50 € |
| 52033 | 252 | 30,00 € |
| 52043 | 246 | 19,00 € |
| 52044 | 244 | 21,00 € |
| 52047 | 90 | 6,50 € |
| 52048 | 90 | 6,00 € |
| 52049 | 42 | 11,00 € |
| 52050 | 53 | 95,00 € |
| 52052 | 52 | 43,00 € |
| 52053 | 255 | 31,00 € |
| 52054 | 255 | 16,00 € |
| 52055 | 204 | 119,00 € |
| 52056 | 155 | 63,00 € |
| 52057 | 125 | 5,00 € |
| 52058 | 125 | 6,50 € |
| 52059 | 27 | 35,50 € |
| 52060 | 27 | 35,50 € |
| 52065 | 125 | 35,50 € |
| 52066 | 164 | 15,50 € |
| 52068 | 38 | 4,00 € |
| 52069 | 208 | 18,00 € |
| 52070 | 208 | 26,50 € |
| 52071 | 208 | 32,00 € |
| 52072 | 38 | 5,50 € |
| 52073 | 37 | 16,50 € |
| 52074 | 37 | 16,50 € |
| 52076 | 138 | 125,50 € |
| 52077 | 118 | 63,50 € |
| 52148 | 74 | 59,50 € |
| 52149 | 218 | 219,00 € |
| 52152 | 49 | 11,50 € |
| 52153 | 141 | 74,00 € |
| 52156 | 100 | 120,50 € |
| 52157 | 101 | 37,50 € |
| 52158 | 247 | 37,50 € |
| 52159 | 101 | 53,00 € |
| 52160 | 101 | 42,00 € |
| 52162 | 210 | 44,00 € |
| 52163 | 249 | 64,00 € |
| 52165 | 101 | 107,00 € |
| 52166 | 101 | 70,00 € |
| 52167 | 101 | 41,50 € |
| 52168 | 101 | 40,00 € |

| REF. | pag. | € |
|-------|------|------------|
| 52169 | 39 | 21,00 € |
| 52170 | 39 | 15,50 € |
| 52171 | 101 | 29,00 € |
| 52172 | 64 | 416,00 € |
| 52180 | 41 | 18,00 € |
| 52181 | 41 | 20,50 € |
| 52182 | 41 | 20,50 € |
| 52183 | 41 | 29,00 € |
| 52184 | 41 | 43,50 € |
| 52185 | 41 | 61,00 € |
| 52186 | 41 | 75,00 € |
| 52188 | 42 | 12,00 € |
| 52189 | 143 | 101,50 € |
| 52190 | 144 | 9,00 € |
| 52191 | 129 | 283,00 € |
| 52192 | 212 | 174,00 € |
| 52193 | 212 | 341,00 € |
| 52194 | 212 | 1.089,00 € |
| 52195 | 214 | 142,00 € |
| 52196 | 214 | 165,00 € |
| 52197 | 46 | 46,00 € |
| 52198 | 26 | 32,00 € |
| 52200 | 220 | 70,50 € |
| 52201 | 220 | 59,50 € |
| 52202 | 220 | 66,00 € |
| 52207 | 45 | 16,50 € |
| 52227 | 160 | 273,00 € |
| 52230 | 219 | 291,50 € |
| 52231 | 210 | 44,00 € |
| 52232 | 82 | 108,00 € |
| 52233 | 209 | 383,00 € |
| 52235 | 56 | 10,50 € |
| 52236 | 56 | 12,00 € |
| 52237 | 56 | 16,00 € |
| 52238 | 56 | 23,50 € |
| 52242 | 197 | 9,50 € |
| 52243 | 197 | 7,00 € |
| 52244 | 126 | 64,00 € |
| 52250 | 153 | 528,00 € |
| 52254 | 82 | 53,50 € |
| 52255 | 82 | 43,50 € |
| 52259 | 229 | 3,50 € |
| 52262 | 122 | 7,00 € |
| 52263 | 122 | 13,00 € |
| 52264 | 122 | 19,50 € |
| 52265 | 122 | 22,00 € |
| 52267 | 122 | 31,00 € |
| 52268 | 123 | 12,50 € |
| 52269 | 132 | 8,00 € |
| 52270 | 149 | 98,00 € |

| REF. | pag. | € |
|-------|------|----------|
| 52271 | 189 | 21,00 € |
| 52272 | 50 | 25,50 € |
| 52273 | 137 | 58,50 € |
| 52275 | 129 | 42,00 € |
| 52276 | 52 | 8,50 € |
| 52277 | 52 | 10,00 € |
| 52278 | 52 | 10,50 € |
| 52279 | 52 | 7,50 € |
| 52280 | 52 | 9,00 € |
| 52281 | 52 | 7,50 € |
| 52282 | 52 | 8,00 € |
| 52283 | 52 | 9,00 € |
| 52284 | 52 | 8,50 € |
| 52290 | 208 | 79,50 € |
| 52291 | 208 | 147,50 € |
| 52292 | 208 | 166,00 € |
| 52293 | 143 | 108,00 € |
| 52294 | 159 | 79,00 € |
| 52295 | 123 | 5,50 € |
| 52296 | 148 | 83,50 € |
| 52297 | 148 | 122,50 € |
| 52298 | 148 | 162,00 € |
| 52299 | 84 | 33,00 € |
| 52300 | 84 | 35,50 € |
| 52302 | 86 | 22,00 € |
| 52303 | 86 | 22,00 € |
| 52304 | 201 | 63,50 € |
| 52305 | 140 | 131,00 € |
| 52306 | 73 | 55,00 € |
| 52307 | 73 | 130,00 € |
| 52308 | 73 | 406,00 € |
| 52309 | 73 | 806,50 € |
| 52310 | 224 | 3,50 € |
| 52311 | 130 | 16,50 € |
| 52312 | 130 | 13,50 € |
| 52313 | 130 | 13,50 € |
| 52314 | 130 | 15,50 € |
| 52315 | 129 | 24,50 € |
| 52316 | 142 | 19,50 € |
| 52317 | 142 | 20,50 € |
| 52318 | 159 | 64,50 € |
| 52319 | 161 | 9,50 € |
| 52320 | 27 | 21,00 € |
| 52321 | 122 | 10,00 € |
| 52325 | 39 | 13,50 € |
| 52327 | 122 | 13,50 € |
| 52328 | 129 | 109,00 € |
| 52329 | 195 | 33,00 € |
| 52330 | 128 | 218,00 € |
| 52331 | 100 | 202,00 € |

| REF. | pag. | € |
|-------|---------|----------|
| 52337 | 108 | 52,50 € |
| 52338 | 109 | 32,50 € |
| 52339 | 111 | 53,00 € |
| 52340 | 111 | 53,00 € |
| 52341 | 108 | 46,50 € |
| 52342 | 108 | 53,00 € |
| 52343 | 109 | 45,50 € |
| 52344 | 111 | 163,00 € |
| 52345 | 108 | 86,50 € |
| 52346 | 108 | 86,50 € |
| 52347 | 112 | 125,50 € |
| 52348 | 112 | 158,50 € |
| 52349 | 56 | 14,00 € |
| 52350 | 56 | 15,50 € |
| 52351 | 56 | 17,00 € |
| 52352 | 56 | 20,50 € |
| 52353 | 56 | 22,50 € |
| 52354 | 56 | 24,00 € |
| 52355 | 56 | 26,00 € |
| 52356 | 56 | 36,50 € |
| 52357 | 56 | 41,00 € |
| 52358 | 56 | 45,50 € |
| 52359 | 56 | 50,50 € |
| 52360 | 67 | 539,00 € |
| 52362 | 91 | 2,00 € |
| 52363 | 91 | 2,00 € |
| 52364 | 91 | 4,50 € |
| 52365 | 91 | 4,00 € |
| 52366 | 91 | 1,00 € |
| 52367 | 91 | 1,00 € |
| 52368 | 91 | 2,00 € |
| 52369 | 91 | 2,00 € |
| 52370 | 91 | 2,00 € |
| 52371 | 91 | 0,50 € |
| 52373 | 68 | 148,50 € |
| 52375 | 84 | 40,00 € |
| 52378 | 102/165 | 9,00 € |
| 52381 | 104 | 17,50 € |
| 52382 | 209 | 20,00 € |
| 52383 | 211 | 18,00 € |
| 52384 | 77 | 35,50 € |
| 52385 | 121 | 108,00 € |
| 52386 | 120 | 21,00 € |
| 52387 | 120 | 22,00 € |
| 52388 | 120 | 25,00 € |
| 52389 | 54 | 29,00 € |
| 52390 | 120 | 31,50 € |
| 52391 | 197 | 10,00 € |
| 52392 | 197 | 8,00 € |
| 52393 | 64 | 792,00 € |

| REF. | pag. | € |
|-------|---------|----------|
| 52394 | 232 | 9,00 € |
| 52395 | 232 | 9,00 € |
| 52396 | 232 | 9,50 € |
| 52397 | 232 | 9,50 € |
| 52398 | 232 | 9,50 € |
| 52399 | 232 | 9,50 € |
| 52400 | 232 | 10,00 € |
| 52401 | 232 | 10,50 € |
| 52402 | 232 | 10,50 € |
| 52403 | 232 | 11,00 € |
| 52404 | 232 | 11,00 € |
| 52405 | 232 | 11,00 € |
| 52406 | 232 | 12,00 € |
| 52407 | 232 | 12,00 € |
| 52408 | 232 | 12,50 € |
| 52409 | 232 | 15,00 € |
| 52410 | 91 | 0,50 € |
| 52411 | 50 | 18,00 € |
| 52412 | 50 | 5,50 € |
| 52414 | 86 | 18,50 € |
| 52415 | 86 | 18,50 € |
| 52416 | 132 | 10,50 € |
| 52417 | 132 | 22,00 € |
| 52418 | 18 | 158,50 € |
| 52419 | 69 | 79,50 € |
| 52420 | 69 | 120,00 € |
| 52421 | 69 | 133,50 € |
| 52422 | 163 | 22,00 € |
| 52424 | 40 | 60,50 € |
| 52425 | 41 | 26,50 € |
| 52426 | 41 | 48,00 € |
| 52427 | 41 | 60,00 € |
| 52428 | 195 | 42,00 € |
| 52429 | 215/217 | 103,50 € |
| 52430 | 222 | 10,50 € |
| 52431 | 222 | 4,00 € |
| 52432 | 149 | 31,00 € |
| 52433 | 154 | 6,50 € |
| 52434 | 129 | 208,00 € |
| 52436 | 211 | 913,00 € |
| 52438 | 210 | 47,50 € |
| 52439 | 210 | 207,00 € |
| 52440 | 222 | 4,50 € |
| 52441 | 222 | 4,50 € |
| 52442 | 222 | 4,50 € |
| 52445 | 222 | 4,50 € |
| 52447 | 223 | 8,50 € |
| 52448 | 223 | 9,50 € |
| 52449 | 223 | 9,50 € |
| 52450 | 210 | 138,50 € |

| REF. | pag. | € |
|-------|------|----------|
| 52451 | 35 | 34,00 € |
| 52452 | 193 | 7,50 € |
| 52453 | 193 | 19,00 € |
| 52454 | 151 | 20,00 € |
| 52455 | 129 | 18,00 € |
| 52456 | 84 | 40,00 € |
| 52458 | 89 | 52,00 € |
| 52460 | 42 | 13,00 € |
| 52461 | 42 | 21,00 € |
| 52462 | 44 | 23,50 € |
| 52463 | 44 | 22,00 € |
| 52464 | 44 | 40,50 € |
| 52466 | 165 | 8,50 € |
| 52467 | 165 | 9,50 € |
| 52468 | 48 | 5,50 € |
| 52472 | 48 | 4,00 € |
| 52473 | 48 | 7,00 € |
| 52474 | 121 | 57,50 € |
| 52475 | 121 | 55,00 € |
| 52476 | 121 | 55,00 € |
| 52477 | 120 | 61,50 € |
| 52478 | 120 | 54,00 € |
| 52479 | 120 | 45,00 € |
| 52480 | 121 | 48,50 € |
| 52481 | 121 | 46,00 € |
| 52482 | 121 | 48,50 € |
| 52483 | 121 | 45,00 € |
| 52484 | 121 | 58,50 € |
| 52485 | 121 | 47,50 € |
| 52486 | 121 | 53,00 € |
| 52487 | 121 | 55,50 € |
| 52488 | 139 | 33,00 € |
| 52489 | 140 | 57,50 € |
| 52490 | 104 | 6,00 € |
| 52491 | 104 | 8,50 € |
| 52493 | 229 | 4,00 € |
| 52494 | 150 | 208,00 € |
| 52495 | 156 | 21,00 € |
| 52497 | 164 | 17,50 € |
| 52498 | 196 | 53,50 € |
| 52499 | 84 | 46,50 € |
| 52500 | 38 | 16,50 € |
| 52501 | 38 | 20,00 € |
| 52502 | 120 | 25,00 € |
| 52503 | 120 | 26,50 € |
| 52504 | 120 | 21,50 € |
| 52505 | 120 | 14,00 € |
| 52506 | 120 | 15,00 € |
| 52507 | 120 | 23,00 € |
| 52508 | 54 | 36,00 € |

| REF. | pag. | € | REF. | pag. | € | REF. | pag. | € | REF. | pag. | € |
|-------|--------|----------|-------|--------|----------|-------|------|----------|-------|---------|----------|
| 52509 | 54 | 37,00 € | 52573 | 223 | 2,50 € | 52643 | 213 | 539,00 € | 52699 | 146 | 17,00 € |
| 52510 | 120 | 29,00 € | 52574 | 99 | 64,00 € | 52644 | 240 | 7,50 € | 52700 | 142 | 20,00 € |
| 52511 | 120 | 40,00 € | 52575 | 44 | 94,00 € | 52645 | 240 | 0,42 € | 52701 | 222 | 34,00 € |
| 52512 | 120 | 41,50 € | 52582 | 80 | 5,50 € | 52646 | 240 | 0,35 € | 52703 | 246 | 14,50 € |
| 52514 | 204 | 70,50 € | 52583 | 154 | 10,00 € | 52648 | 103 | 7,00 € | 52705 | 59 | 768,00 € |
| 52515 | 55/161 | 10,50 € | 52584 | 79 | 11,00 € | 52649 | 237 | 5,50 € | 52706 | 59 | 768,00 € |
| 52516 | 165 | 24,00 € | 52585 | 46 | 32,50 € | 52650 | 237 | 5,50 € | 52707 | 59 | 572,00 € |
| 52517 | 165 | 10,50 € | 52586 | 46 | 40,00 € | 52651 | 236 | 4,50 € | 52708 | 59 | 572,00 € |
| 52518 | 131 | 82,00 € | 52587 | 46 | 30,00 € | 52652 | 236 | 3,50 € | 52709 | 59 | 572,00 € |
| 52519 | 30 | 34,00 € | 52588 | 46 | 30,50 € | 52653 | 236 | 3,50 € | 52711 | 247 | 23,50 € |
| 52520 | 30 | 42,00 € | 52589 | 123 | 11,00 € | 52654 | 238 | 7,00 € | 52712 | 17 | 92,50 € |
| 52521 | 30 | 120,00 € | 52591 | 162 | 13,50 € | 52655 | 237 | 38,00 € | 52713 | 14 | 75,00 € |
| 52524 | 47 | 48,00 € | 52592 | 162 | 21,00 € | 52656 | 237 | 28,50 € | 52714 | 26 | 14,00 € |
| 52525 | 47 | 12,50 € | 52593 | 162 | 34,50 € | 52657 | 237 | 42,00 € | 52715 | 26 | 8,50 € |
| 52526 | 47 | 25,50 € | 52595 | 44 | 55,00 € | 52658 | 237 | 42,00 € | 52716 | 26 | 15,00 € |
| 52527 | 101 | 65,50 € | 52596 | 44 | 104,50 € | 52659 | 237 | 42,00 € | 52717 | 26 | 9,50 € |
| 52528 | 99 | 48,50 € | 52597 | 44 | 126,00 € | 52660 | 239 | 75,00 € | 52718 | 101 | 37,50 € |
| 52529 | 104 | 29,00 € | 52601 | 194 | 328,00 € | 52661 | 239 | 247,50 € | 52719 | 249 | 0,21 € |
| 52530 | 231 | 12,00 € | 52603 | 22 | 68,50 € | 52662 | 237 | 33,00 € | 52720 | 13 | 26,50 € |
| 52531 | 122 | 6,50 € | 52604 | 22 | 73,00 € | 52663 | 237 | 30,00 € | 52721 | 14 | 53,00 € |
| 52533 | 122 | 11,00 € | 52605 | 22 | 73,00 € | 52664 | 238 | 218,00 € | 52722 | 13 | 97,00 € |
| 52534 | 231 | 13,50 € | 52606 | 22 | 75,00 € | 52665 | 233 | 0,29 € | 52723 | 14 | 46,50 € |
| 52535 | 231 | 10,50 € | 52607 | 132 | 41,50 € | 52666 | 233 | 0,29 € | 52724 | 99 | 321,50 € |
| 52536 | 78 | 46,50 € | 52608 | 132 | 47,00 € | 52667 | 234 | 0,70 € | 52725 | 99 | 308,50 € |
| 52538 | 28 | 62,00 € | 52609 | 44 | 30,50 € | 52668 | 234 | 1,50 € | 52727 | 148 | 30,00 € |
| 52539 | 28 | 62,00 € | 52613 | 161 | 17,00 € | 52669 | 234 | 2,00 € | 52728 | 148 | 64,00 € |
| 52540 | 96 | 176,00 € | 52615 | 130 | 93,00 € | 52670 | 234 | 3,00 € | 52729 | 148 | 153,00 € |
| 52541 | 145 | 35,50 € | 52616 | 190 | 41,50 € | 52671 | 234 | 3,50 € | 52730 | 148 | 341,00 € |
| 52542 | 74 | 109,00 € | 52617 | 133 | 5,50 € | 52672 | 234 | 4,00 € | 52731 | 148 | 37,50 € |
| 52543 | 103 | 142,00 € | 52618 | 227 | 57,50 € | 52673 | 236 | 20,00 € | 52732 | 148 | 67,50 € |
| 52544 | 112 | 75,00 € | 52619 | 53 | 25,50 € | 52674 | 122 | 122,00 € | 52733 | 148 | 126,50 € |
| 52545 | 112 | 152,00 € | 52620 | 164 | 8,00 € | 52675 | 100 | 76,50 € | 52734 | 160 | 42,00 € |
| 52546 | 111 | 32,00 € | 52621 | 161 | 8,00 € | 52676 | 100 | 84,50 € | 52735 | 105 | 5,00 € |
| 52547 | 108 | 75,00 € | 52622 | 136 | 72,00 € | 52677 | 132 | 14,00 € | 52736 | 105 | 5,00 € |
| 52549 | 83 | 68,50 € | 52624 | 144 | 16,50 € | 52678 | 132 | 14,50 € | 52737 | 105 | 5,00 € |
| 52550 | 21 | 82,00 € | 52625 | 54/129 | 8,00 € | 52681 | 223 | 9,50 € | 52738 | 224 | 4,00 € |
| 52551 | 151 | 142,00 € | 52626 | 147 | 34,50 € | 52682 | 223 | 10,00 € | 52739 | 224 | 4,00 € |
| 52552 | 239 | 203,50 € | 52627 | 147 | 75,00 € | 52683 | 223 | 10,00 € | 52740 | 82 | 544,50 € |
| 52555 | 80 | 3,00 € | 52628 | 196 | 29,50 € | 52684 | 37 | 29,50 € | 52741 | 89 | 198,00 € |
| 52556 | 80 | 3,00 € | 52629 | 136 | 93,00 € | 52685 | 139 | 75,00 € | 52742 | 230 | 68,50 € |
| 52557 | 80 | 3,00 € | 52633 | 240 | 0,88 € | 52687 | 157 | 185,00 € | 52743 | 230 | 38,50 € |
| 52558 | 80 | 3,00 € | 52634 | 69 | 4,50 € | 52689 | 98 | 159,00 € | 52744 | 230 | 42,00 € |
| 52565 | 41 | 10,00 € | 52635 | 69 | 4,00 € | 52690 | 143 | 37,00 € | 52748 | 39 | 38,00 € |
| 52566 | 86 | 27,50 € | 52636 | 128 | 139,50 € | 52691 | 142 | 54,00 € | 52749 | 124 | 54,00 € |
| 52567 | 86 | 27,50 € | 52637 | 152 | 44,50 € | 52692 | 205 | 116,00 € | 52753 | 21 | 95,00 € |
| 52568 | 87 | 27,50 € | 52638 | 55 | 5,50 € | 52693 | 161 | 40,50 € | 52754 | 139 | 53,00 € |
| 52569 | 87 | 27,50 € | 52639 | 146 | 155,00 € | 52694 | 110 | 38,50 € | 52755 | 106/217 | 108,00 € |
| 52570 | 223 | 2,50 € | 52640 | 145 | 60,50 € | 52696 | 162 | 7,50 € | 52756 | 165 | 7,00 € |
| 52571 | 223 | 2,50 € | 52641 | 145 | 65,00 € | 52697 | 162 | 11,00 € | 52757 | 162 | 20,00 € |
| 52572 | 223 | 2,50 € | 52642 | 146 | 26,00 € | 52698 | 146 | 26,50 € | 52758 | 100 | 76,50 € |

* I prezzi al dettaglio. Tasse non incluse.



WWW.JBMCAMP.COM

JBM
2019

277

| REF. | pag. | € |
|-------|---------|------------|
| 52759 | 55 | 16,00 € |
| 52760 | 55/161 | 5,00 € |
| 52761 | 50 | 8,00 € |
| 52762 | 50 | 8,50 € |
| 52765 | 122 | 24,50 € |
| 52767 | 97 | 361,00 € |
| 52768 | 226 | 20,50 € |
| 52769 | 226 | 20,50 € |
| 52770 | 226 | 20,50 € |
| 52771 | 226 | 20,50 € |
| 52772 | 226 | 20,50 € |
| 52773 | 226 | 20,50 € |
| 52774 | 226 | 20,50 € |
| 52775 | 226 | 20,50 € |
| 52776 | 226 | 20,50 € |
| 52777 | 226 | 20,50 € |
| 52778 | 226 | 20,50 € |
| 52779 | 226 | 20,50 € |
| 52780 | 226 | 20,50 € |
| 52781 | 226 | 20,50 € |
| 52782 | 226 | 20,50 € |
| 52783 | 226 | 20,50 € |
| 52786 | 49 | 12,50 € |
| 52787 | 104 | 7,00 € |
| 52788 | 118 | 42,00 € |
| 52789 | 195 | 16,00 € |
| 52790 | 93 | 185,00 € |
| 52791 | 53 | 18,00 € |
| 52793 | 154 | 78,00 € |
| 52794 | 154 | 32,50 € |
| 52795 | 226 | 5,50 € |
| 52796 | 155 | 94,00 € |
| 52797 | 195 | 219,00 € |
| 52798 | 104 | 14,50 € |
| 52800 | 109 | 13,50 € |
| 52801 | 137/195 | 24,50 € |
| 52802 | 142 | 42,00 € |
| 52804 | 192 | 268,50 € |
| 52805 | 192 | 319,00 € |
| 52806 | 192 | 511,50 € |
| 52807 | 192 | 1.319,00 € |
| 52808 | 226 | 8,50 € |
| 52809 | 130 | 10,50 € |
| 52810 | 111 | 10,50 € |
| 52811 | 111 | 10,50 € |
| 52812 | 54 | 55,00 € |
| 52813 | 137 | 97,00 € |
| 52814 | 95 | 493,00 € |
| 52815 | 140 | 125,50 € |
| 52816 | 140 | 25,50 € |

| REF. | pag. | € |
|-------|------|----------|
| 52817 | 140 | 24,00 € |
| 52818 | 236 | 185,00 € |
| 52819 | 190 | 26,50 € |
| 52820 | 137 | 36,00 € |
| 52821 | 134 | 23,50 € |
| 52822 | 137 | 33,00 € |
| 52823 | 141 | 169,50 € |
| 52824 | 217 | 589,50 € |
| 52825 | 59 | 768,00 € |
| 52826 | 64 | 319,00 € |
| 52827 | 84 | 41,00 € |
| 52828 | 84 | 41,00 € |
| 52829 | 239 | 20,00 € |
| 52830 | 42 | 22,50 € |
| 52831 | 42 | 15,50 € |
| 52832 | 143 | 64,50 € |
| 52833 | 142 | 43,50 € |
| 52834 | 149 | 214,00 € |
| 52835 | 149 | 233,50 € |
| 52836 | 82 | 979,00 € |
| 52838 | 89 | 59,00 € |
| 52839 | 89 | 61,50 € |
| 52840 | 6 | 163,00 € |
| 52842 | 238 | 7,50 € |
| 52843 | 85 | 28,00 € |
| 52844 | 157 | 76,00 € |
| 52845 | 204 | 132,00 € |
| 52846 | 52 | 42,00 € |
| 52847 | 52 | 42,00 € |
| 52848 | 89 | 83,50 € |
| 52849 | 152 | 7,00 € |
| 52850 | 135 | 7,00 € |
| 52851 | 119 | 9,00 € |
| 52852 | 54 | 4,50 € |
| 52855 | 235 | 319,00 € |
| 52856 | 236 | 68,50 € |
| 52857 | 264 | 6,50 € |
| 52858 | 135 | 273,00 € |
| 52859 | 91 | 0,50 € |
| 52860 | 91 | 0,50 € |
| 52861 | 91 | 0,50 € |
| 52862 | 91 | 2,00 € |
| 52863 | 91 | 2,00 € |
| 52864 | 91 | 2,00 € |
| 52865 | 91 | 0,50 € |
| 52866 | 91 | 0,50 € |
| 52867 | 91 | 1,00 € |
| 52868 | 91 | 0,50 € |
| 52869 | 73 | 47,50 € |
| 52870 | 73 | 100,50 € |

| REF. | pag. | € |
|-------|--------|----------|
| 52871 | 73 | 219,00 € |
| 52873 | 153 | 10,00 € |
| 52874 | 145 | 65,50 € |
| 52875 | 145 | 71,50 € |
| 52876 | 117 | 169,50 € |
| 52877 | 49 | 14,50 € |
| 52878 | 49 | 12,50 € |
| 52879 | 49 | 12,50 € |
| 52880 | 47/238 | 27,50 € |
| 52881 | 47/238 | 13,50 € |
| 52882 | 163 | 11,00 € |
| 52883 | 78 | 42,00 € |
| 52884 | 209 | 56,00 € |
| 52885 | 55 | 18,00 € |
| 52886 | 256 | 17,50 € |
| 52887 | 256 | 19,00 € |
| 52888 | 259 | 20,00 € |
| 52889 | 257 | 17,00 € |
| 52890 | 258 | 16,00 € |
| 52891 | 257 | 20,50 € |
| 52892 | 258 | 16,00 € |
| 52893 | 258 | 20,50 € |
| 52894 | 258 | 18,00 € |
| 52895 | 259 | 18,00 € |
| 52896 | 256 | 22,00 € |
| 52897 | 259 | 34,00 € |
| 52898 | 259 | 27,00 € |
| 52899 | 256 | 27,50 € |
| 52900 | 257 | 27,00 € |
| 52901 | 257 | 30,50 € |
| 52904 | 154 | 48,50 € |
| 52905 | 49 | 31,00 € |
| 52906 | 129 | 84,00 € |
| 52908 | 27 | 16,00 € |
| 52909 | 27 | 11,00 € |
| 52910 | 84 | 41,50 € |
| 52912 | 36 | 85,50 € |
| 52913 | 152 | 300,00 € |
| 52914 | 114 | 196,50 € |
| 52915 | 114 | 177,50 € |
| 52916 | 114 | 169,50 € |
| 52917 | 114 | 108,50 € |
| 52918 | 114 | 130,00 € |
| 52919 | 114 | 161,50 € |
| 52920 | 114 | 126,00 € |
| 52921 | 114 | 92,00 € |
| 52922 | 114 | 129,00 € |
| 52923 | 114 | 40,00 € |
| 52924 | 114 | 46,50 € |
| 52925 | 114 | 124,00 € |

| REF. | pag. | € |
|-------|-------|----------|
| 52926 | 114 | 158,00 € |
| 52927 | 114 | 54,50 € |
| 52928 | 114 | 125,50 € |
| 52929 | 114 | 135,00 € |
| 52930 | 115 | 108,00 € |
| 52931 | 115 | 36,50 € |
| 52932 | 115 | 37,00 € |
| 52933 | 115 | 147,00 € |
| 52934 | 115 | 84,00 € |
| 52935 | 115 | 89,50 € |
| 52936 | 115 | 151,50 € |
| 52937 | 115 | 208,00 € |
| 52938 | 115 | 154,50 € |
| 52939 | 115 | 27,00 € |
| 52940 | 115 | 187,50 € |
| 52941 | 115 | 59,50 € |
| 52942 | 115 | 77,50 € |
| 52943 | 115 | 71,50 € |
| 52944 | 115 | 95,50 € |
| 52945 | 115 | 196,50 € |
| 52946 | 84 | 41,50 € |
| 52947 | 152 | 18,00 € |
| 52948 | 45 | 27,50 € |
| 52949 | 45 | 27,50 € |
| 52950 | 45 | 16,00 € |
| 52951 | 45 | 16,00 € |
| 52952 | 209 | 71,50 € |
| 52953 | 102 | 29,00 € |
| 52954 | 208 | 61,50 € |
| 52955 | 56 | 17,00 € |
| 52956 | 56 | 20,00 € |
| 52957 | 56 | 24,00 € |
| 52958 | 56 | 31,50 € |
| 52959 | 56 | 43,00 € |
| 52960 | 56 | 52,00 € |
| 52961 | 143 | 83,50 € |
| 52962 | 141 | 97,00 € |
| 52963 | 217 | 59,50 € |
| 52964 | 51 | 10,00 € |
| 52965 | 51 | 10,00 € |
| 52966 | 51 | 10,00 € |
| 52967 | 51 | 10,00 € |
| 52969 | 109 | 17,00 € |
| 52970 | 34 | 36,50 € |
| 52971 | 34 | 52,00 € |
| 52972 | 23/37 | 87,00 € |
| 52973 | 35 | 51,00 € |
| 52974 | 35 | 17,00 € |
| 52975 | 35 | 68,50 € |
| 52976 | 35 | 22,00 € |

| REF. | pag. | € |
|-------|--------|----------|
| 52977 | 118 | 108,00 € |
| 52978 | 8 | 86,00 € |
| 52979 | 7 | 87,00 € |
| 52980 | 213 | 405,00 € |
| 52981 | 93 | 218,00 € |
| 52982 | 51/121 | 47,00 € |
| 52983 | 97 | 163,00 € |
| 52985 | 203 | 389,50 € |
| 52987 | 78 | 31,00 € |
| 52991 | 197 | 7,50 € |
| 52992 | 197 | 13,00 € |
| 52995 | 264 | 214,50 € |
| 52998 | 122 | 61,00 € |
| 52999 | 202 | 158,50 € |
| 53001 | 156 | 264,00 € |
| 53007 | 91 | 0,50 € |
| 53008 | 131 | 16,00 € |
| 53009 | 135 | 40,00 € |
| 53010 | 38 | 16,50 € |
| 53011 | 9 | 77,00 € |
| 53017 | 32 | 57,50 € |
| 53018 | 33 | 136,50 € |
| 53019 | 32 | 71,50 € |
| 53020 | 33 | 230,00 € |
| 53021 | 32 | 48,50 € |
| 53022 | 32 | 46,50 € |
| 53025 | 154 | 3,50 € |
| 53026 | 154 | 5,50 € |
| 53027 | 154 | 8,00 € |
| 53028 | 210 | 4,00 € |
| 53029 | 210 | 4,50 € |
| 53030 | 210 | 10,00 € |
| 53031 | 73 | 50,50 € |
| 53032 | 73 | 109,00 € |
| 53033 | 228 | 12,00 € |
| 53034 | 61 | 627,00 € |
| 53035 | 61 | 945,00 € |
| 53036 | 61 | 945,00 € |
| 53037 | 240 | 0,33 € |
| 53038 | 240 | 0,33 € |
| 53039 | 240 | 0,39 € |
| 53040 | 240 | 0,33 € |
| 53041 | 138 | 42,00 € |
| 53042 | 153 | 12,00 € |
| 53043 | 111 | 35,50 € |
| 53044 | 110 | 108,00 € |
| 53045 | 87 | 42,50 € |
| 53046 | 87 | 37,50 € |
| 53047 | 88 | 292,50 € |
| 53048 | 88 | 93,50 € |

| REF. | pag. | € |
|-------|------|----------|
| 53049 | 87 | 93,50 € |
| 53050 | 88 | 93,50 € |
| 53051 | 88 | 186,50 € |
| 53052 | 88 | 186,50 € |
| 53053 | 144 | 9,50 € |
| 53054 | 162 | 4,00 € |
| 53055 | 161 | 32,00 € |
| 53056 | 150 | 109,00 € |
| 53057 | 156 | 169,50 € |
| 53058 | 150 | 169,50 € |
| 53059 | 150 | 46,50 € |
| 53060 | 109 | 30,50 € |
| 53061 | 19 | 43,00 € |
| 53062 | 147 | 145,50 € |
| 53063 | 105 | 32,00 € |
| 53064 | 105 | 32,00 € |
| 53065 | 105 | 32,00 € |
| 53066 | 105 | 53,00 € |
| 53067 | 105 | 53,00 € |
| 53068 | 105 | 53,00 € |
| 53069 | 134 | 123,50 € |
| 53070 | 56 | 15,00 € |
| 53071 | 56 | 19,50 € |
| 53072 | 56 | 28,00 € |
| 53073 | 56 | 42,50 € |
| 53074 | 10 | 76,00 € |
| 53075 | 11 | 54,00 € |
| 53076 | 23 | 86,00 € |
| 53077 | 110 | 62,00 € |
| 53078 | 193 | 16,00 € |
| 53079 | 124 | 65,00 € |
| 53080 | 124 | 74,50 € |
| 53081 | 152 | 108,00 € |
| 53082 | 152 | 128,00 € |
| 53083 | 43 | 48,50 € |
| 53084 | 26 | 21,00 € |
| 53085 | 79 | 26,50 € |
| 53086 | 162 | 10,00 € |
| 53087 | 226 | 13,00 € |
| 53088 | 226 | 13,00 € |
| 53089 | 226 | 13,00 € |
| 53090 | 226 | 13,00 € |
| 53091 | 226 | 12,00 € |
| 53092 | 226 | 12,00 € |
| 53093 | 226 | 12,00 € |
| 53094 | 226 | 12,00 € |
| 53095 | 42 | 15,50 € |
| 53096 | 162 | 42,00 € |
| 53098 | 45 | 14,50 € |
| 53099 | 45 | 16,50 € |

| REF. | pag. | € |
|-------|---------|----------|
| 53100 | 45 | 20,00 € |
| 53101 | 12 | 36,50 € |
| 53102 | 12 | 36,50 € |
| 53103 | 19 | 33,00 € |
| 53104 | 20 | 33,00 € |
| 53105 | 20 | 33,00 € |
| 53106 | 16 | 98,00 € |
| 53107 | 13 | 30,00 € |
| 53108 | 13 | 98,00 € |
| 53109 | 193 | 219,00 € |
| 53110 | 119 | 24,50 € |
| 53111 | 211 | 13,50 € |
| 53112 | 199 | 191,50 € |
| 53113 | 61 | 945,00 € |
| 53115 | 106/217 | 147,50 € |
| 53116 | 66 | 109,50 € |
| 53117 | 65 | 103,00 € |
| 53118 | 159 | 228,00 € |
| 53119 | 163 | 35,50 € |
| 53120 | 43 | 4,50 € |
| 53121 | 43 | 5,50 € |
| 53122 | 43 | 7,00 € |
| 53123 | 124 | 43,00 € |
| 53124 | 124 | 225,50 € |
| 53125 | 123 | 368,50 € |
| 53126 | 123 | 168,50 € |
| 53127 | 26 | 8,50 € |
| 53128 | 226 | 4,00 € |
| 53129 | 151 | 62,00 € |
| 53130 | 83 | 53,00 € |
| 53131 | 83 | 53,00 € |
| 53134 | 123 | 104,50 € |
| 53135 | 95 | 515,00 € |
| 53136 | 99 | 167,00 € |
| 53137 | 98 | 42,00 € |
| 53140 | 99 | 93,50 € |
| 53141 | 98 | 66,50 € |
| 53142 | 98 | 314,50 € |
| 53144 | 197 | 15,50 € |
| 53145 | 211 | 32,50 € |
| 53146 | 147 | 24,50 € |
| 53147 | 102 | 30,00 € |
| 53150 | 215 | 18,50 € |
| 53151 | 89 | 14,00 € |
| 53152 | 29 | 378,00 € |
| 53153 | 29 | 409,50 € |
| 53154 | 29 | 471,00 € |
| 53156 | 26 | 23,50 € |
| 53157 | 236 | 68,50 € |
| 53158 | 24 | 167,00 € |

| REF. | pag. | € |
|-------|------|----------|
| 53159 | 25 | 288,50 € |
| 53160 | 24 | 272,50 € |
| 53162 | 211 | 52,50 € |
| 53163 | 85 | 37,00 € |
| 53164 | 30 | 15,00 € |
| 53165 | 30 | 18,00 € |
| 53166 | 215 | 9,50 € |
| 53167 | 215 | 12,00 € |
| 53168 | 215 | 18,00 € |
| 53169 | 225 | 12,50 € |
| 53170 | 225 | 12,50 € |
| 53171 | 225 | 12,50 € |
| 53172 | 225 | 12,50 € |
| 53173 | 225 | 16,50 € |
| 53174 | 225 | 16,50 € |
| 53175 | 225 | 16,50 € |
| 53176 | 225 | 16,50 € |
| 53177 | 225 | 13,00 € |
| 53178 | 225 | 13,00 € |
| 53179 | 225 | 13,00 € |
| 53180 | 225 | 13,00 € |
| 53181 | 225 | 18,00 € |
| 53182 | 225 | 18,00 € |
| 53183 | 225 | 18,00 € |
| 53184 | 225 | 18,00 € |
| 53185 | 225 | 14,50 € |
| 53186 | 225 | 19,00 € |
| 53187 | 197 | 26,00 € |
| 53188 | 197 | 4,50 € |
| 53189 | 215 | 98,50 € |
| 53190 | 215 | 82,50 € |
| 53191 | 126 | 11,00 € |
| 53192 | 126 | 47,50 € |
| 53193 | 70 | 329,00 € |
| 53194 | 62 | 379,50 € |
| 53195 | 62 | 548,00 € |
| 53196 | 164 | 18,00 € |
| 53197 | 110 | 41,00 € |
| 53198 | 197 | 7,00 € |
| 53199 | 81 | 44,50 € |
| 53200 | 201 | 76,00 € |
| 53201 | 15 | 35,50 € |
| 53202 | 105 | 17,50 € |
| 53203 | 91 | 0,50 € |
| 53204 | 105 | 62,00 € |
| 53205 | 104 | 16,50 € |
| 53206 | 131 | 30,00 € |
| 53207 | 141 | 96,00 € |
| 53208 | 141 | 119,00 € |
| 53209 | 209 | 6,00 € |

* I prezzi al dettaglio. Tasse non incluse.



WWW.JBMCAMP.COM

JBM
2019

279

| REF. | pag. | € |
|-------|---------|----------|
| 53210 | 56 | 34,00 € |
| 53211 | 74 | 59,50 € |
| 53212 | 15 | 163,00 € |
| 53213 | 106/217 | 147,50 € |
| 53214 | 192 | 247,50 € |
| 53215 | 197 | 16,50 € |
| 53216 | 77 | 48,50 € |
| 53217 | 77 | 32,00 € |
| 53218 | 200 | 19,50 € |
| 53219 | 11 | 54,00 € |
| 53220 | 213 | 285,00 € |
| 53221 | 229 | 4,00 € |
| 53222 | 71 | 43,00 € |
| 53223 | 193 | 318,00 € |
| 53224 | 117 | 169,00 € |
| 53225 | 40 | 3,50 € |
| 53226 | 126 | 12,00 € |
| 53227 | 79 | 26,00 € |
| 53229 | 248 | 31,00 € |
| 53230 | 119 | 17,00 € |
| 53231 | 128 | 33,00 € |
| 53232 | 119 | 43,00 € |
| 53233 | 229 | 18,00 € |
| 53234 | 229 | 8,00 € |
| 53235 | 133 | 11,00 € |
| 53236 | 133 | 13,00 € |
| 53237 | 133 | 14,00 € |
| 53238 | 133 | 16,50 € |
| 53240 | 163 | 41,50 € |
| 53241 | 231 | 7,00 € |
| 53242 | 224 | 2,00 € |
| 53243 | 224 | 2,00 € |
| 53244 | 224 | 2,00 € |
| 53245 | 224 | 2,00 € |
| 53246 | 206 | 858,00 € |
| 53248 | 81 | 108,00 € |
| 53249 | 163 | 177,50 € |
| 53250 | 135 | 98,50 € |
| 53251 | 162 | 89,00 € |
| 53252 | 72 | 47,00 € |
| 53253 | 72 | 131,50 € |
| 53256 | 234 | 26,50 € |
| 53258 | 72 | 83,00 € |
| 53259 | 167 | 108,00 € |
| 53260 | 167 | 239,00 € |
| 53261 | 167 | 216,00 € |
| 53262 | 168 | 240,00 € |
| 53263 | 168 | 62,50 € |
| 53264 | 168 | 145,00 € |
| 53265 | 169 | 197,50 € |

| REF. | pag. | € |
|-------|------|----------|
| 53266 | 169 | 217,00 € |
| 53267 | 169 | 273,00 € |
| 53268 | 170 | 119,00 € |
| 53269 | 170 | 51,00 € |
| 53270 | 170 | 68,50 € |
| 53271 | 171 | 228,00 € |
| 53272 | 171 | 179,50 € |
| 53273 | 171 | 75,00 € |
| 53274 | 173 | 44,00 € |
| 53275 | 176 | 39,50 € |
| 53276 | 172 | 161,00 € |
| 53277 | 172 | 37,50 € |
| 53278 | 172 | 145,50 € |
| 53279 | 173 | 98,00 € |
| 53280 | 172 | 107,50 € |
| 53281 | 173 | 59,00 € |
| 53282 | 173 | 53,00 € |
| 53283 | 174 | 101,50 € |
| 53284 | 174 | 313,50 € |
| 53285 | 175 | 53,50 € |
| 53286 | 175 | 104,50 € |
| 53287 | 175 | 244,00 € |
| 53288 | 176 | 79,50 € |
| 53289 | 177 | 55,00 € |
| 53290 | 177 | 54,00 € |
| 53291 | 178 | 75,00 € |
| 53292 | 178 | 131,00 € |
| 53293 | 178 | 147,00 € |
| 53294 | 179 | 122,50 € |
| 53295 | 180 | 85,00 € |
| 53296 | 180 | 64,50 € |
| 53297 | 180 | 49,00 € |
| 53298 | 181 | 89,00 € |
| 53299 | 181 | 284,50 € |
| 53300 | 181 | 44,00 € |
| 53301 | 182 | 56,50 € |
| 53302 | 182 | 51,00 € |
| 53303 | 182 | 143,00 € |
| 53304 | 183 | 264,00 € |
| 53305 | 183 | 144,00 € |
| 53306 | 184 | 60,00 € |
| 53307 | 184 | 42,50 € |
| 53308 | 185 | 58,00 € |
| 53309 | 185 | 279,50 € |
| 53310 | 185 | 468,50 € |
| 53311 | 186 | 107,00 € |
| 53312 | 186 | 145,50 € |
| 53313 | 186 | 153,00 € |
| 53314 | 187 | 99,00 € |
| 53315 | 187 | 279,50 € |

| REF. | pag. | € |
|-------|------|----------|
| 53316 | 184 | 30,00 € |
| 53317 | 190 | 31,00 € |
| 53318 | 188 | 25,50 € |
| 53319 | 187 | 34,50 € |
| 53320 | 188 | 12,00 € |
| 53321 | 190 | 10,50 € |
| 53323 | 188 | 10,00 € |
| 53324 | 179 | 13,50 € |
| 53325 | 190 | 6,50 € |
| 53326 | 174 | 15,00 € |
| 53327 | 174 | 15,00 € |
| 53328 | 141 | 101,50 € |
| 53330 | 136 | 30,50 € |
| 53331 | 43 | 28,50 € |
| 53332 | 43 | 31,00 € |
| 53339 | 43 | 8,50 € |
| 53340 | 248 | 74,50 € |
| 53343 | 98 | 277,00 € |
| 53344 | 98 | 320,00 € |
| 53346 | 46 | 18,00 € |
| 53347 | 159 | 93,00 € |
| 53348 | 243 | 9,00 € |
| 53349 | 243 | 9,00 € |
| 53350 | 243 | 11,00 € |
| 53351 | 244 | 11,00 € |
| 53352 | 244 | 11,00 € |
| 53353 | 250 | 14,50 € |
| 53354 | 245 | 11,00 € |
| 53355 | 254 | 9,50 € |
| 53356 | 254 | 10,50 € |
| 53357 | 254 | 4,00 € |
| 53358 | 253 | 10,00 € |
| 53359 | 252 | 13,00 € |
| 53360 | 246 | 13,00 € |
| 53361 | 246 | 17,50 € |
| 53362 | 245 | 10,00 € |
| 53363 | 244 | 22,00 € |
| 53364 | 244 | 11,00 € |
| 53365 | 246 | 12,50 € |
| 53366 | 245 | 10,00 € |
| 53367 | 254 | 7,00 € |
| 53368 | 254 | 6,50 € |
| 53369 | 245 | 10,50 € |
| 53370 | 243 | 21,50 € |
| 53371 | 244 | 22,00 € |
| 53372 | 243 | 23,50 € |
| 53373 | 250 | 12,50 € |
| 53374 | 252 | 8,00 € |
| 53376 | 252 | 8,50 € |
| 53377 | 248 | 18,00 € |

| REF. | pag. | € |
|-------|--------|----------|
| 53378 | 251 | 11,00 € |
| 53379 | 247 | 12,50 € |
| 53380 | 255 | 9,50 € |
| 53381 | 250 | 11,00 € |
| 53382 | 250 | 8,00 € |
| 53383 | 250 | 8,00 € |
| 53384 | 146 | 143,50 € |
| 53385 | 50/256 | 16,00 € |
| 53386 | 206 | 638,00 € |
| 53387 | 208 | 237,00 € |
| 53388 | 149 | 88,50 € |
| 53389 | 51 | 25,00 € |
| 53390 | 53 | 30,00 € |
| 53391 | 148 | 64,50 € |
| 53392 | 156 | 49,00 € |
| 53393 | 148 | 108,50 € |
| 53394 | 160 | 571,50 € |
| 53395 | 164 | 15,50 € |
| 53396 | 53 | 15,50 € |
| 53397 | 17 | 163,00 € |
| 53398 | 17 | 163,00 € |
| 53399 | 253 | 3,50 € |
| 53400 | 253 | 4,00 € |
| 53401 | 253 | 5,00 € |
| 53402 | 253 | 8,50 € |
| 53403 | 253 | 6,00 € |
| 53404 | 253 | 6,00 € |
| 53405 | 253 | 4,50 € |
| 53406 | 253 | 7,50 € |
| 53407 | 253 | 11,00 € |
| 53408 | 253 | 17,00 € |
| 53409 | 253 | 8,50 € |
| 53410 | 156 | 82,50 € |
| 53411 | 49 | 4,00 € |
| 53412 | 49 | 3,00 € |
| 53413 | 126 | 4,50 € |
| 53414 | 118 | 54,50 € |
| 53415 | 118 | 168,00 € |
| 53416 | 103 | 13,00 € |
| 53417 | 103 | 21,50 € |
| 53418 | 103 | 11,50 € |
| 53419 | 238 | 9,00 € |
| 53420 | 36 | 62,50 € |
| 53421 | 200 | 208,00 € |
| 53422 | 199 | 295,00 € |
| 53423 | 206 | 171,00 € |
| 53424 | 236 | 68,50 € |
| 53425 | 236 | 68,50 € |
| 53426 | 139 | 28,00 € |
| 53427 | 80 | 4,00 € |

| REF. | pag. | € |
|-------|--------|------------|
| 53428 | 87 | 14,50 € |
| 53429 | 87 | 14,50 € |
| 53430 | 115 | 224,50 € |
| 53431 | 76 | 37,50 € |
| 53432 | 76 | 41,50 € |
| 53433 | 76 | 50,00 € |
| 53434 | 252 | 14,50 € |
| 53435 | 60 | 1.083,50 € |
| 53436 | 60 | 1.083,50 € |
| 53439 | 77 | 21,00 € |
| 53441 | 130 | 6,50 € |
| 53443 | 229 | 7,00 € |
| 53444 | 24 | 185,50 € |
| 53445 | 50 | 12,50 € |
| 53446 | 61 | 945,00 € |
| 53449 | 103 | 18,00 € |
| 53450 | 103 | 23,00 € |
| 53451 | 79/158 | 40,00 € |
| 53452 | 181 | 29,50 € |
| 53453 | 217 | 5,00 € |
| 53454 | 83 | 51,00 € |
| 53455 | 83 | 54,50 € |
| 53456 | 158 | 90,00 € |
| 53457 | 157 | 23,50 € |
| 53458 | 157 | 4,00 € |
| 53459 | 157 | 66,50 € |
| 53460 | 93 | 218,00 € |
| 53461 | 61 | 627,00 € |
| 53462 | 61 | 627,00 € |
| 53463 | 151 | 94,00 € |
| 53464 | 249 | 117,00 € |
| 53465 | 76 | 38,50 € |
| 53466 | 76 | 43,00 € |
| 53467 | 76 | 51,00 € |
| 53468 | 47 | 9,00 € |
| 53470 | 112 | 143,00 € |
| 53472 | 133 | 8,50 € |
| 53473 | 133 | 33,00 € |
| 53474 | 163 | 71,50 € |
| 53477 | 164 | 33,00 € |
| 53478 | 47 | 4,50 € |
| 53479 | 47 | 6,00 € |
| 53480 | 47 | 21,50 € |
| 53481 | 47 | 32,50 € |
| 53484 | 211 | 762,50 € |
| 53485 | 159 | 122,50 € |
| 53486 | 117 | 27,00 € |
| 53487 | 54 | 16,00 € |
| 53488 | 161 | 54,50 € |
| 53489 | 139 | 66,00 € |

| REF. | pag. | € |
|-------|---------|------------|
| 53490 | 140 | 302,50 € |
| 53491 | 97/212 | 603,00 € |
| 53492 | 102/262 | 291,50 € |
| 53493 | 227 | 16,50 € |
| 53494 | 227 | 19,00 € |
| 53495 | 227 | 29,00 € |
| 53496 | 227 | 16,50 € |
| 53497 | 227 | 19,00 € |
| 53498 | 227 | 29,00 € |
| 53499 | 158 | 28,00 € |
| 53500 | 158 | 28,00 € |
| 53501 | 135 | 19,00 € |
| 53502 | 142 | 35,50 € |
| 53503 | 210 | 9,00 € |
| 53504 | 264 | 53,00 € |
| 53505 | 82 | 53,00 € |
| 53506 | 82 | 26,50 € |
| 53507 | 228 | 27,00 € |
| 53508 | 228 | 9,50 € |
| 53510 | 264 | 12,50 € |
| 53511 | 264 | 16,50 € |
| 53512 | 264 | 50,00 € |
| 53513 | 265 | 9,50 € |
| 53514 | 58 | 1.098,00 € |
| 53516 | 86 | 58,50 € |
| 53517 | 49 | 8,00 € |
| 53518 | 193 | 2,00 € |
| 53519 | 78 | 32,00 € |
| 53520 | 93 | 218,00 € |
| 53521 | 264 | 273,00 € |
| 53522 | 135 | 21,50 € |
| 53523 | 177 | 99,00 € |
| 53524 | 55 | 40,50 € |
| 53525 | 164 | 12,50 € |
| 53526 | 215/217 | 108,00 € |
| 53530 | 79/158 | 43,00 € |
| 53531 | 108 | 86,50 € |
| 53532 | 106/217 | 97,00 € |
| 53534 | 59 | 768,00 € |
| 53535 | 59 | 572,00 € |
| 53540 | 225 | 22,00 € |
| 53546 | 63 | 1.265,00 € |
| 53547 | 51 | 15,00 € |
| 53548 | 51 | 15,00 € |
| 53549 | 51 | 15,00 € |
| 53550 | 51 | 15,00 € |
| 53555 | 58 | 1.098,00 € |
| 53556 | 58 | 1.098,00 € |
| 53557 | 58 | 1.098,00 € |
| 70001 | 261 | 35,50 € |

| REF. | pag. | € |
|----------|---------|----------|
| 70002 | 261 | 35,50 € |
| 70003 | 261 | 35,50 € |
| 70004 | 261 | 42,00 € |
| 70005 | 261 | 42,00 € |
| 70006 | 261 | 42,00 € |
| 70007 | 261 | 35,50 € |
| 70008 | 261 | 35,50 € |
| 70009 | 261 | 35,50 € |
| 70010 | 261 | 42,00 € |
| 70011 | 261 | 42,00 € |
| 70012 | 261 | 42,00 € |
| 90003 | 103 | 39,00 € |
| 90004 | 103 | 28,50 € |
| 51398N | 223 | 1,50 € |
| 51632N | 223 | 1,50 € |
| 51636N | 223 | 1,50 € |
| 51638N | 223 | 1,50 € |
| 51640N | 223 | 1,50 € |
| 51642N | 223 | 1,50 € |
| JBMWB13 | 232 | 9,00 € |
| JBMWB14 | 232 | 9,50 € |
| JBMWB15 | 232 | 10,00 € |
| JBMWB16 | 232 | 10,50 € |
| JBMWB17 | 232 | 12,00 € |
| JBMWB18 | 232 | 12,00 € |
| JBMWB18S | 232 | 7,50 € |
| JBMWB19 | 232 | 12,50 € |
| JBMWB19S | 232 | 8,00 € |
| JBMWB20 | 232 | 13,00 € |
| JBMWB20S | 232 | 8,00 € |
| JBMWB21 | 232 | 14,00 € |
| JBMWB21S | 232 | 8,50 € |
| JBMWB22 | 232 | 14,00 € |
| JBMWB22S | 232 | 9,00 € |
| JBMWB24 | 232 | 15,00 € |
| JBMWB24S | 232 | 9,50 € |
| JBMWB26S | 232 | 11,50 € |
| JBMWB28S | 232 | 13,00 € |
| METEXP | 231/264 | 53,00 € |
| SERIE124 | 240 | 438,00 € |
| SERIE75 | 103 | 201,50 € |

* I prezzi al dettaglio.
Tasse non incluse.

* Prezzi validi fino al 31 dicembre
2019, edizione del nuovo
catalogo, revisione del prezzo o
fino ad esaurimento scorte.



ZEAT s.r.l.

**Via Galvani, 9
35030 Selvazzano Dentro (Padova)
Z.I. Caselle**

Tel: +39 049.631930

Fax: +39 049.8907155

info@zeat.eu

www.zeat.eu

distributore