

PROTECT YOUR JEWELS



KOVIX 
INNOVATIVE SECURITY SYSTEM

**DOES IT
FIT?
Check now!**



MOTORCYCLE SECURITY SYSTEMS

SISTEMI DI SICUREZZA PER MOTO / MOTORRAD SICHERHEITSSYSTEME

CATALOGO PRODOTTI / PRODUKTKATALOG / CATALOGUE DES PRODUITS / ΚΑΤΑΛΟΓ ΤΟΒΑΡΩΒ / CATALOGO DE PRODUCTOS

www.kovix-security.eu



WANT TO FIND OUT WHICH DISCLOCK IS BEST FOR YOUR MOTORCYCLE?



VUOI SCOPRIRE QUALE BLOCCADISCO VA MEGLIO SULLA TUA MOTOCICLETTA?



SCAN THE QR CODE

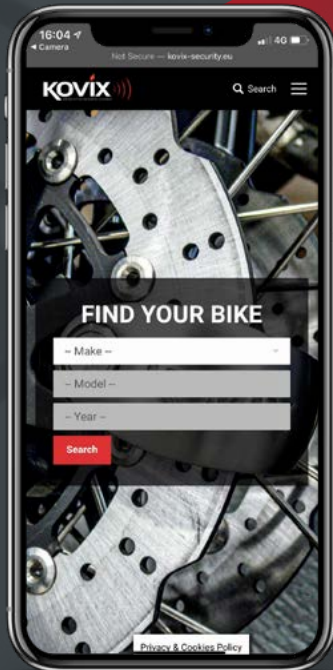

INSERISCI LA TUA MOTO, E SCOPRI QUALI PRODOTTI KOVIX SONO PIÙ ADATTI PER LA TUA MOTO!



INSERT YOUR MOTORCYCLE AND QUICKLY DISCOVER WHICH PRODUCTS FIT YOUR BIKE!



¡ELIGE TU MOTOCICLETA Y DESCUBRE QUÉ PRODUCTOS SE ADAPTAN MEJOR A TU MOTO!



INSÉREZ VOTRE MOTO ET DÉCOUVREZ LES PRODUITS ADAPTÉS À VOTRE MOTO!



SETZEN SIE IHR MOTORRAD EIN UND ENTDECKEN SIE, WELCHE PRODUKTE ZU IHREM MOTORRAD PASSEN!



OR VISIT OUR WEBSITE WWW.KOVIX-SECURITY.EU



OPPURE VISITA IL SITO WWW.KOVIX-SECURITY.EU

INSERISCI LA TUA MOTO, E SCOPRI QUALI PRODOTTI KOVIX SONO PIÙ ADATTI PER LA TUA MOTO!



INSERT YOUR MOTORCYCLE AND QUICKLY DISCOVER WHICH PRODUCTS FIT YOUR BIKE!



¡ELIGE SU MOTOCICLETA Y DESCUBRE QUÉ PRODUCTOS TE ADAPTAN MEJOR A TU MOTO!



INSÉREZ VOTRE MOTO ET DÉCOUVREZ LES PRODUITS ADAPTÉS À VOTRE MOTO!



SETZEN SIE IHR MOTORRAD EIN UND ENTDECKEN SIE, WELCHE PRODUKTE ZU IHREM MOTORRAD PASSEN!





THE SECURITY RATINGS WE HAVE ON LOCK



LE CERTIFICAZIONI CHE ABBIAMO OTTENUTO

SBSC - SWEDEN'S LEADING CERTIFICATION BODY IN SECURITY



Alcuni dei nostri prodotti hanno ricevuto la certificazione System 5 "Fondamenti di certificazione del prodotto e linee guida per gli schemi di certificazione del prodotto secondo (ISO / IEC 17067: 2013)" da SBSC. Questa certificazione è valida al momento della creazione del catalogo.



Some of our products received the System 5 certification "Fundamentals of product certification and guidelines for product certification schemes according to (ISO/IEC 17067:2013)" by SBSC. This certification is valid at the time of creation of the catalogue.



Algunos productos recibieron la certificación del Sistema 5 "Fundamentos de la certificación de productos y directrices para los esquemas de certificación de productos de acuerdo con (ISO / IEC 17067: 2013)" por SBSC. Esta certificación es válida en el momento de la creación del catálogo.



Certains de nos produits ont reçu la certification Système 5 «Principes de base de la certification des produits et directives pour les programmes de certification de produits selon (ISO / CEI 17067: 2013)» par SBSC. Cette certification est valable au moment de la création du catalogue.



Einige unserer Produkte erhielten von SBSC die System 5-Zertifizierung „Grundlagen der Produktzertifizierung und Richtlinien für Produktzertifizierungssysteme gemäß (ISO / IEC 17067: 2013)“. Diese Zertifizierung ist zum Zeitpunkt der Erstellung des Katalogs gültig.

ART FOUNDATION



Alcuni dei nostri prodotti hanno ricevuto una valutazione dalla fondazione ART, che promuove le disposizioni di sicurezza contro il furto. Nota, la certificazione è valida al momento della creazione di questo catalogo.



Some of our products received a 4 star rating from the ART foundation, which promotes the safety provisions against theft. Note, the certification is valid at the time of creation of this catalogue.



Algunos de nuestros productos recibieron una calificación de la fundación ART, que promueve las disposiciones de seguridad contra el robo. Tenga en cuenta que la certificación es válida en el momento de la creación de este catálogo.



Certains de nos produits ont reçu une note de 4 étoiles de la fondation ART, qui promeut les dispositions de sécurité contre le vol. Notez que la certification est valide au moment de la création de ce catalogue.



Einige unserer Produkte wurden von der ART Foundation mit 4 Sternen bewertet, was die Sicherheitsbestimmungen gegen Diebstahl fördert. Beachten Sie, dass die Zertifizierung zum Zeitpunkt der Erstellung dieses Katalogs gültig ist.

SWEDISH NATIONAL TESTING & RESEARCH INSTITUTE (SP)



Alcuni dei nostri prodotti sono certificati dal Swedish National Testing & Research Institute (SP). Nota, la certificazione è valida al momento della creazione di questo catalogo.



Some of our products are certified by the Swedish National Testing & Research Institute (SP). Note, the certification is valid at the time of creation of this catalogue.



Algunos de nuestros productos están certificados por el Instituto Nacional Sueco de Pruebas e Investigación (SP). Tenga en cuenta que la certificación es válida en el momento de la creación de este catálogo.



Certains de nos produits sont certifiés par le Swedish National Testing & Research Institute (SP). Notez que la certification est valide au moment de la création de ce catalogue.



Einige unserer Produkte sind vom schwedischen National Testing & Research Institute (SP) zertifiziert. Beachten Sie, dass die Zertifizierung zum Zeitpunkt der Erstellung dieses Katalogs gültig ist.

SOLD SECURE - THE TEST HOUSE OF CHOICE FOR SECURITY PRODUCTS



Alcuni dei nostri prodotti hanno ottenuto il voto Gold nella casa di sicurezza e certificazione Sold Secure. Nota, la certificazione è valida al momento della creazione di questo catalogo.



Some of our products scored Gold on the Sold Secure UK Premier security and certification system. Note, the certification is valid at the time of creation of this catalogue.



Algunos de nuestros productos obtuvieron "Gold" en el sistema de seguridad y certificación Sold Secure UK Premier. Tenga en cuenta que la certificación es válida en el momento de la creación de este catálogo.



Certains de nos produits ont obtenu la note «Gold» sur le système de sécurité et de certification Sold Secure UK Premier. Notez que la certification est valide au moment de la création de ce catalogue.



Einige unserer Produkte wurden im Sold Secure UK Premier Sicherheits- und Zertifizierungssystem mit "Gold" ausgezeichnet. Beachten Sie, dass die Zertifizierung zum Zeitpunkt der Erstellung dieses Katalogs gültig ist.

CE MARKING



Grazie alla certificazione CE, introdotta dalla Decisione 93/465 / CEE, tutti i nostri prodotti sono conformi ai requisiti di sicurezza delle direttive e dei regolamenti europei.



Thanks to the CE certification, introduced by the Decision 93/465/CEE, all our products comply with the safety requirements of the European directives and regulations.



Gracias a la certificación CE, introducida por la Decisión 93/465 / CEE, todos nuestros productos cumplen con los requisitos de seguridad de las directivas y regulaciones europeas.







Grâce à la certification CE, introduite par la décision 93/465 / CEE, tous nos produits sont conformes aux exigences de sécurité des directives et règlements européens.



Dank der CE-Zertifizierung, die durch die Entscheidung 93/465 / CEE eingeführt wurde, erfüllen alle unsere Produkte die Sicherheitsanforderungen der europäischen Richtlinien und Vorschriften.

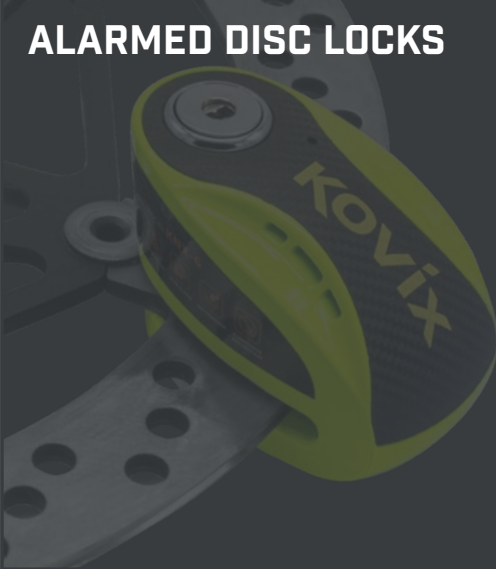

IT. Tutte le immagini sono inserite a scopo illustrativo. I prodotti possono subire modifiche senza preavviso.
EN. All images are inserted for illustrative purposes. Products are subject to change without notice.

 <p>ALARMED DISC LOCKS</p>	KNX15	1
	KNX12	2
	KAL SERIES	3
	KNX 10	4
	KNX 6	5
	KD6 SERIES	6
	KT6/CB	7
	KS6 SERIES	8
 <p>DISC LOCKS</p>	KVS2-SS	9
	KVZ2 SERIES	10
	KVZ1 SERIES	11
	KNN6/CB	12
	KN1 SERIES	13
	KNN1 SERIES	14
 <p>CHAINS, CABLES AND LOCKS</p>	KFQ SERIES	15
	KHL SERIES	16
	KWL SERIES	17
	KCL SERIES	18
	KCK10-150	19
 <p>MISCELLANEOUS</p>	SECURITY CABLES	20
	ACCESSORIES	21
	DISPLAY STANDS	22

KNX 15

ALARM DISC LOCK

CERTIFIED:



SECURITY RATING

1 2 3 4 5 6 7 8 9



INCLUDES:



CODE	COLOR	MATERIAL	PIN SIZE	LOCK SYSTEM
KNX15	Stainless steel	Stainless steel	14mm	Double locking carbide pin

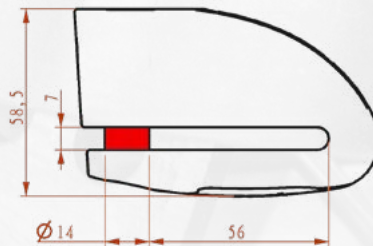

COLOURS COLORI/FARBEN



EN	Alarm disc lock - 120dB alarm - weatherproof electronics - Stainless steel key barrel - material: hardened steel - Lithium long battery life Alarm function selection - Double locking carbide pin -Stainless steel body - anti corrosion treatment - ultra resistant - 100% rustproof triaxial anti lift motion sensor - high safety key and cylinder
IT	Bloccadisco allarmato - Sirena da 120dB - Modulo allarmato stagno - materiale: acciaio temperato - Batteria al litio lunga durata - Selezione modalità allarme Doppio serraggio del perno - Corpo d'acciaio inossidabile - Trattamento anti corrosione - Super resistente - 100% anti ruggine Sensore di movimento e sollevamento triassiale - Chiave e cilindro di massima sicurezza
ES	Bloqueo disco de sonido / Alarmado - Sirena de 120 dB - Módulo de alarma con protección contra la lluvia - Pasador de acero inoxidable Material: acero templado - Batería de litio de larga duración - Selección del modo de alarma - Doble apriete del pasador* - Cuerpo de acero inoxidable Tratamiento anticorrosión - 100% antioxidante - Sensor de movimiento y elevación triaxial - Llave y cilindro de máxima seguridad
DE	Alarmbremsscheibenschloss - 120dB Alarm Geräusch - Wetter-Geschützte Elektronik - Edelstahl-Schlüssel Aufnahme - Material: gehärteter Stahl Langlebige Lithium-Batterie - Alarmfunktions Auswahl - Doppelspann-Stift - Gehäuse aus Edelstahl - Anti-Korrosions-Behandlung - Extrem Beständig 100% Korrosions Beständig - Bewegungssensor und dreiachsiger Spezial - Schlüssel und Hochsicherheitszylinder
FR	Disclock Alarm - Système alarme à 120db - électronique à l'épreuve des intempéries - Mécanisme de verrouillage pin en acier inoxydable Matériau: Acier cémenté - Lithium batteries longue durée - Sélection de la fonction d'alarme - Double mécanisme de verrouillage Corps en acier inoxydable - Traitement anti-corrosion - Super résistant - 100% anti-rouille - Capteur de mouvement triaxial - Verouillage de haute sécurité
RU	Предупреждение о блокировке диска - Сигнал тревоги 120 дБ - Электроника устойчивая к атмосферным влияниям - Цилиндр замка из нержавеющей стали - Материал: нержавеющая сталь - Литиевая батарейка с продолжительным временем работы - Выбор функции аварийной сигнализации Двойной стопорный карбидный штифт - Корпус из нержавеющей стали - Антикоррозийная обработка - Ультрастойкий Предотвращение ржавления 100% - Трехосевой датчик движения против подъема - Предохранительный ключ и цилиндр

KNX 12

ALARM DISC LOCK

CERTIFIED:



SECURITY RATING

1 2 3 4 5 6 7 8 9



INCLUDES:



CODE	COLOR	MATERIAL	PIN SIZE	LOCK SYSTEM
KNX12	Stainless steel	Stainless steel	12mm	Double locking carbide pin

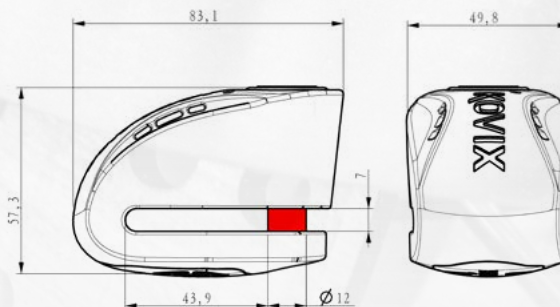

COLOURS

COLORI/FARBEN

EN

Alarm disc lock - 120dB alarm - weatherproof electronics - Stainless steel key barrel - material: hardened steel - Lithium long battery life
Alarm function selection - Double locking carbide pin -Stainless steel body - anti corrosion treatment - ultra resistant - 100% rustproof
triaxial anti lift motion sensor - high safety key and cylinder

IT

Bloccadisco allarmato - Sirena da 120dB - Modulo allarmato stagno - materiale: acciaio temperato - Batteria al litio lunga durata - Selezione modalità allarme
Doppio serraggio del perno - Corpo d'acciaio inossidabile - Trattamento anti corrosione - Super resistente - 100% anti ruggine
Sensore di movimento e sollevamento triassiale - Chiave e cilindro di massima sicurezza

ES

Bloqueo disco de sonido / Alarmado - Sirena de 120 dB - Módulo de alarma con protección contra la lluvia - Pasador de acero inoxidable
Material: acero templado - Batería de litio de larga duración - Selección del modo de alarma - Doble apriete del pasador* - Cuerpo de acero inoxidable
Tratamiento anticorrosión - 100% antioxidante - Sensor de movimiento y elevación triaxial - Llave y cilindro de máxima seguridad

DE

Alarmbremsscheibenschloss - 120dB Alarm Geräusch - Wetter-Geschützte Elektronik - Edelstahl-Schlüssel Aufnahme - Material: gehärteter Stahl
Langlebige Lithium-Batterie - Alarmfunktions Auswahl - Doppelspann-Stift - Gehäuse aus Edelstahl - Anti-Korrosions-Behandlung - Extrem Beständig
100% Korrosions Beständig - Bewegungssensor und dreiachsiger Spezial - Schlüssel und Hochsicherheitszylinder

FR

Disclock Alarm - Système alarme à 120db - électronique à l'épreuve des intempéries - Mécanisme de verrouillage pin en acier inoxydable
Matériau: Acier cémenté - Lithium batteries longue durée - Sélection de la fonction d'alarme - Double mécanisme de verrouillage
Corps en acier inoxydable - Traitement anti-corrosion - Super résistant - 100% anti-rouille - Capteur de mouvement triaxial - Verouillage de haute sécurité

RU

Предупреждение о блокировке диска - Сигнал тревоги 120 дБ - Электроника устойчивая к атмосферным влияниям - Цилиндр замка из нержавеющей стали - Материал: нержавеющая сталь - Литиевая батарейка с продолжительным временем работы - Выбор функции аварийной сигнализации
Двойной стопорный карбидный штифт - Корпус из нержавеющей стали - Антикоррозийная обработка - Ультрастойкий
Предотвращение ржавления 100% - Трехосевой датчик движения против подъема - Предохранительный ключ и цилиндр

KAL SERIES

ALARM DISC LOCK

CERTIFIED:



SECURITY RATING

1 2 3 4 5 6 7 8 9 10



INCLUDES:



CODE	COLOR	MATERIAL	PIN SIZE	LOCK SYSTEM
KAL14	Stainless steel	Stainless steel	14mm	Double lock carbide pin
KAL10	Stainless steel	Stainless steel	10mm	Double lock carbide pin

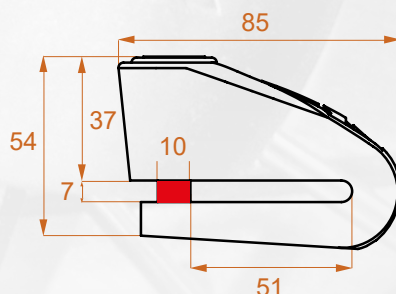
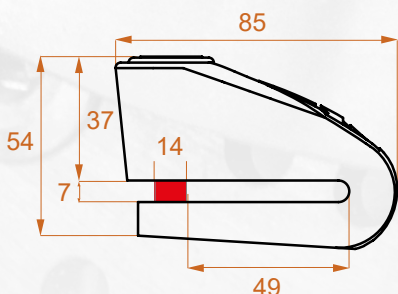

COLOURS

COLORI/FARBEN



EN

Alarm disc lock - 120dB alarm - weatherproof electronics - Stainless steel key barrel - material: hardened steel - material: zinc alloy* - Lithium long battery life
Alarm function selection - Double locking carbide pin - push-down locking system* - Stainless steel body - anti corrosion treatment - ultra resistant
100% rustproof - triaxial anti lift motion sensor - high safety key and cylinder

IT

Bloccadisco allarmato - Sirena da 120dB - Modulo allarmato stagno - materiale: acciaio temperato - materiale: lega di zinco* - Batteria al litio lunga durata
Selezione modalità allarme - Doppio serraggio del perno - Sistema di chiusura a pressione* - Corpo d'acciaio inossidabile - Trattamento anti corrosione
Super resistente - 100% anti ruggine - Sensore di movimento e sollevamento triassiale - Chiave e cilindro di massima sicurezza

ES

Bloqueo disco de sonido / Alarmado - Sirena de 120 dB - Módulo de alarma con protección contra la lluvia - Pasador de acero inoxidable - Material: acero templado -
Material: aleación de zinc* - Batería de litio de larga duración - Selección del modo de alarma - Doble apriete del pasador* - Sistema de cierre a presión - Cuerpo de
acero inoxidable - Tratamiento anticorrosión - 100% antioxidante - Sensor de movimiento y elevación triaxial - Llave y cilindro de máxima seguridad

DE

Alarmbremsscheibenschloss - 120dB Alarm Geräusch - Wetter-Geschützte Elektronik - Edelstahl-Schlüssel Aufnahme - Material: gehärteter Stahl
Material: Zink-Legierung* - Langlebige Lithium-Batterie - Alarmfunktions Auswahl - Doppelspann-Stift - Gehäuse aus Edelstahl - Anti-Korrosions-Behandlung
Extrem Beständig - 100% Korrosions Beständig - Bewegungssensor und dreiachsiger Spezial - Schlüssel und Hochsicherheitszylinder

FR

Disclock Alarm - Système alarme à 120db - électronique à l'épreuve des intempéries - Mécanisme de verrouillage pin en acier inoxydable
Matériau: Acier cémenté - Matériau: Zinc alliage* - Lithium batteries longue durée - Sélection de la fonction d'alarme - Double mécanisme de verrouillage
Corps en acier inoxydable - Traitement anti-corrosion - Super résistant - 100% anti-rouille - Capteur de mouvement triaxial - Verouillage de haute sécurité

RU

Предупреждение о блокировке диска - Сигнал тревоги 120 дБ - Электроника устойчивая к атмосферным влияниям - Цилиндр замка из нержавеющей
стали - Материал: нержавеющая сталь - Литиевая батарейка с продолжительным временем работы - Выбор функции аварийной сигнализации
Двойной стопорный карбидный штифт - Корпус из нержавеющей стали - Антикоррозийная обработка - Ультрастойкий
Предотвращение ржавления 100% - Трехосевой датчик движения против подъема - Предохранительный ключ и цилиндр

KNX 10

ALARM DISC LOCK

SECURITY RATING

1 2 3 4 5 6 7 8 9 10



INCLUDES:



CODE	COLOR	MATERIAL	PIN SIZE	LOCK SYSTEM
KNX10-BM	Stainless steel	Zinc-alloy	10mm	Push-Down Locking System
KNX10-FG	Fluo Green	Zinc-alloy	10mm	Push-Down Locking System

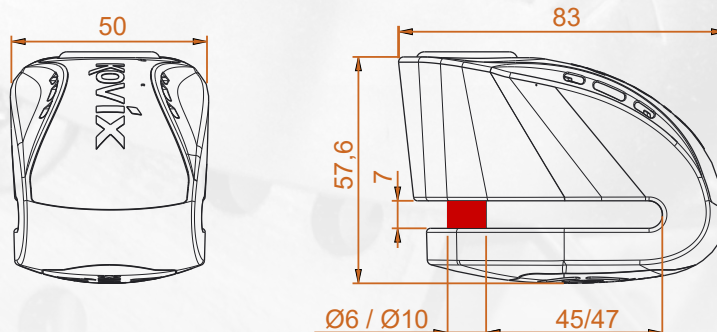

COLOURS

COLORI/FARBEN

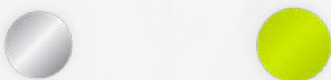

EN Alarm disc lock - 120dB alarm - Alarm module protected by zinc alloy - Weatherproof electronics - Lithium Long Battery Life - Alarm Function selection
Stainless steel key barrel - Push-down Locking system - 100% rust proof - High quality cast - triaxial anti-lift motion sensor - High Safety key and cylinder

IT Bloccadisco sonoro / allarmato - Sirena da 120dB - Modulo allarmato protetto in lega di zinco - Modulo allarme con protezione pioggia
Batteria al litio lunga durata - Perno in acciaio inossidabile - Sistema di chiusura a pressione - 100% anti ruggine - Fusione di alta qualità
Sensore di movimento e sollevamento triassiale - Chiave e cilindro di massima sicurezza

ES Bloqueo disco de sonido / Alarmado - Sirena de 120 dB - Módulo de alarma protegido en aleación de zinc - Módulo de alarma con protección contra la lluvia
Batería de litio de larga duración - Selección del modo de alarma - Perno de acero inoxidable - Sistema de cierre a presión - 100% antioxidante
Fundición de alta calidad - Sensor de movimiento y elevación triaxial - Llave y cilindro de máxima seguridad

DE Alarmbremsscheibenschloss - 120dB Alarm Geräusch - Alarmmodul durch Zinklegierung geschützt - Wetter-Geschützte Elektronik
Langlebige Lithium-Batterie - Alarmfunktions Auswahl - Edelstahl-Schlüssel Aufnahme - Druck Verriegelungssystem
100% Korrosions Beständig - Hochwertiger Guss - Bewegungssensor und dreiachsiger Spezial - Schlüssel und Hochsicherheitszylinder

FR Disclock Alarm - Système alarme à 120db - Module alarme protégée en alliage de zinc - électronique à l'épreuve des intempéries
Lithium batteries longue durée - Sélection de la fonction d'allarme - Mécanisme de verrouillage pin en acier inoxydable - Push-Down serrure - 100% anti-rouille
Usinage de haute qualité - Capteur de mouvement triaxial - Verouillage de haute sécurité

RU Предупреждение о блокировке диска - Сигнал тревоги 120 дБ - Модуль аварийной сигнализации защищен сплавом цинка - Электроника устойчивая к атмосферным влияниям - Литиевая батарейка с продолжительным временем работы - Выбор функции аварийной сигнализации
Цилиндр замка из нержавеющей стали - Система блокировки Push-Down - Предотвращение ржавления 100% - Высокое качество отливки
Трехосевой датчик движения против подъема - Предохранительный ключ и цилиндр

KNX6

ALARM DISC LOCK

SECURITY RATING

1 2 3 4 5 6 7 8 9 10



INCLUDES:



CODE	COLOR	MATERIAL	PIN SIZE	LOCK SYSTEM
KNX6-BM	Stainless steel	Zinc-alloy	6mm	Push-Down Locking System
KNX6-FG	Fluo Green	Zinc-alloy	6mm	Push-Down Locking System

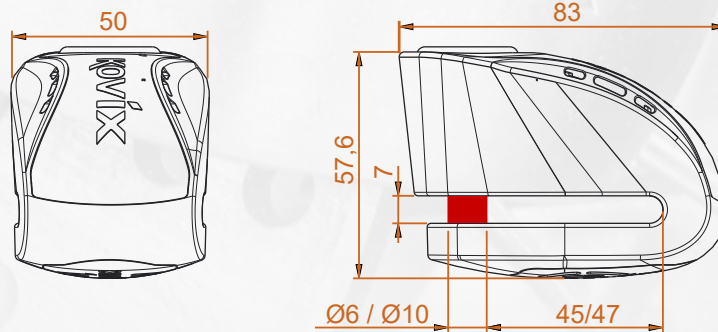

COLOURS

COLORI/FARBEN

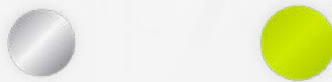

EN	Alarm disc lock - 120dB alarm - Alarm module protected by zinc alloy - Weatherproof electronics - Lithium Long Battery Life - Alarm Function selection Stainless steel key barrel - Push-down Locking system - 100% rust proof - High quality cast - triaxial anti-lift motion sensor - High Safety key and cylinder
IT	Bloccadisco sonoro / allarmato - Sirena da 120dB - Modulo allarmato protetto in lega di zinco - Modulo allarme con protezione pioggia Batteria al litio lunga durata - Perno in acciaio inossidabile - Sistema di chiusura a pressione - 100% anti ruggine - Fusione di alta qualità Sensore di movimento e sollevamento triassiale - Chiave e cilindro di massima sicurezza
ES	Bloqueo disco de sonido / Alarmado - Sirena de 120 dB - Módulo de alarma protegido en aleación de zinc - Módulo de alarma con protección contra la lluvia Batería de litio de larga duración - Selección del modo de alarma - Perno de acero inoxidable - Sistema de cierre a presión - 100% antioxidante Fundición de alta calidad - Sensor de movimiento y elevación triaxial - Llave y cilindro de máxima seguridad
DE	Alarmbremms Scheibenschloss - 120dB Alarm Geräusch - Alarmmodul durch Zinklegierung geschützt - Wetter-Geschützte Elektronik Langlebige Lithium-Batterie - Alarmfunktions Auswahl - Edelstahl-Schlüssel Aufnahme - Druck Verriegelungssystem 100% Korrosions Beständig - Hochwertiger Guss - Bewegungssensor und dreiachsiger Spezial - Schlüssel und Hochsicherheitszylinder
FR	Disclock Alarm - Système alarme à 120db - Module alarme protégée en alliage de zinc - électronique à l'épreuve des intempéries Lithium batteries longue durée - Sélection de la fonction d'alarme - Mécanisme de verrouillage pin en acier inoxydable - Push-Down serrure - 100% anti-rouille Usinage de haute qualité - Capteur de mouvement triaxial - Verouillage de haute sécurité
RU	Предупреждение о блокировке диска - Сигнал тревоги 120 дБ - Модуль аварийной сигнализации защищен сплавом цинка - Электроника устойчивая к атмосферным влияниям - Литиевая батарейка с продолжительным временем работы - Выбор функции аварийной сигнализации Цилиндр замка из нержавеющей стали - Система блокировки Push-Down - Предотвращение ржавления 100% - Высокое качество отливки Трехосевой датчик движения против подъема - Предохранительный ключ и цилиндр

KD6 SERIES

6mm LOCK PIN ALARM DISC LOCK

SECURITY RATING

1 2 3 4 5 6 7 8 9 10



INCLUDES:



CODE	COLOR	MATERIAL	PIN SIZE	LOCK SYSTEM
KD6-BM	Stainless steel	Zinc-alloy	6mm	Push-Down Locking System
KD6-FG	Fluo Green	Zinc-alloy	6mm	Push-Down Locking System
KD6-FO	Fluo Orange	Zinc-alloy	6mm	Push-Down Locking System

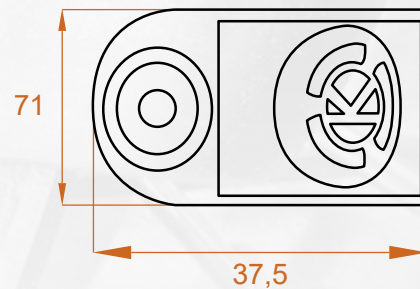
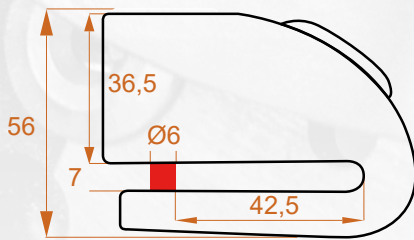

COLOURS

COLORI/FARBEN



EN Alarm disc lock - 120dB alarm - Alarm module protected by zinc alloy - Weatherproof electronics - Lithium Long Battery Life - Alarm Function selection
Stainless steel key barrel - Push-down Locking system - 100% rust proof - High quality cast - triaxial anti-lift motion sensor - High Safety key and cylinder

IT Bloccadisco sonoro / allarmato - Sirena da 120dB - Modulo allarmato protetto in lega di zinco - Modulo allarme con protezione pioggia
Batteria al litio lunga durata - Perno in acciaio inossidabile - Sistema di chiusura a pressione - 100% anti ruggine - Fusione di alta qualità
Sensore di movimento e sollevamento triassiale - Chiave e cilindro di massima sicurezza

ES Bloqueo disco de sonido / Alarmado - Sirena de 120 dB - Módulo de alarma protegido en aleación de zinc - Módulo de alarma con protección contra la lluvia
Batería de litio de larga duración - Selección del modo de alarma - Perno de acero inoxidable - Sistema de cierre a presión - 100% antioxidante
Fundición de alta calidad - Sensor de movimiento y elevación triaxial - Llave y cilindro de máxima seguridad

DE Alarmbremsscheibenschloss - 120dB Alarm Geräusch - Alarmmodul durch Zinklegierung geschützt - Wetter-Geschützte Elektronik
Langlebige Lithium-Batterie - Alarmfunktions Auswahl - Edelstahl-Schlüssel Aufnahme - Druck Verriegelungssystem
100% Korrosions Beständig - Hochwertiger Guss - Bewegungssensor und dreiachsiger Spezial - Schlüssel und Hochsicherheitszylinder

FR Disclock Alarm - Système alarme à 120db - Module alarme protégée en alliage de zinc - électronique à l'épreuve des intempéries
Lithium batteries longue durée - Sélection de la fonction d'allarme - Mécanisme de verrouillage pin en acier inoxydable - Push-Down serrure - 100% anti-rouille
Usinage de haute qualité - Capteur de mouvement triaxial - Verouillage de haute sécurité

RU Предупреждение о блокировке диска - Сигнал тревоги 120 дБ - Модуль аварийной сигнализации защищен сплавом цинка - Электроника устойчивая к атмосферным влияниям - Литиевая батарейка с продолжительным временем работы - Выбор функции аварийной сигнализации
Цилиндр замка из нержавеющей стали - Система блокировки Push-Down - Предотвращение ржавления 100% - Высокое качество отливки
Трехосевой датчик движения против подъема - Предохранительный ключ и цилиндр

KT6/CB

6mm LOCK PIN ALARM DISC LOCK



SECURITY RATING

1 2 3 4 5 6 7 8 9 10



INCLUDES:



CODE	COLOR	MATERIAL	PIN SIZE	LOCK SYSTEM
KT6/CB-FG	● Fluo Green	Manganese	6mm	Push-Down Locking System

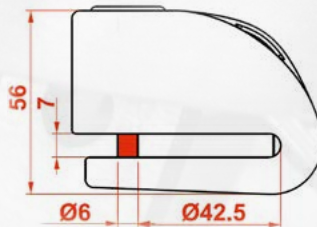

COLOURS

COLORI/FARBEN



EN	Sound lock / alarmed - 120dB siren - Alarmed module protected by manganese alloy - Rainproof alarm module Long-lasting lithium battery - Stainless steel pin - Snap-lock closure system - 100% rust-free - High-quality casting Triaxial motion and lifting sensor - Maximum security key and cylinder
IT	Bloccadisco sonoro / allarmato - Sirena da 120dB - Modulo allarmato protetto in lega di manganese - Modulo allarme con protezione pioggia Batteria al litio lunga durata - Perno in acciaio inossidabile - Sistema di chiusura a pressione - 100% anti ruggine - Fusione di alta qualità Sensore di movimento e sollevamento triassiale - Chiave e cilindro di massima sicurezza
ES	Bloqueo de sonido / alarmado - Sirena de 120dB - Módulo alarmado protegido por aleación de manganese - Módulo de alarma a prueba de lluvia Batería de litio de larga duración - Pasador de acero inoxidable - Sistema de cierre de presión - 100% sin óxido - Fundición de alta calidad Sensor de movimiento y elevación triaxial - Llave y cilindro de máxima seguridad
DE	Schallblockierung / Alarm - 120dB-Sirene - Alarmer Modul geschützt durch Manganlegierung - Regensicheres Alarmermodul Langlebiger Lithium-Akku - Edelstahlpfosten - Snap-Lock-Verschlussystem - 100% rostfrei - Hochwertige Gießerei Triaxialer Bewegungs- und Hubsensor - Maximale Sicherheitsschlüssel und -zylinder
FR	Disclock Alarm - Sirène de 120 dB - Module alarmé protégé par un alliage de manganèse - Module d'alarme étanche à la pluie Batterie lithium longue durée - Broche en acier inoxydable - Système de fermeture à pression - 100% antirouille - Coulée de haute qualité Capteur de mouvement et de levage triaxial - Clé et cylindre de sécurité maximale
RU	Звуковой замок / сигнализированный - Сирена на 120 дБ - Сигнализируемый модуль, защищенный марганцевым сплавом - Сигнализируемый модуль, защищенный от дождя - Долговечный литий-ионный аккумулятор - Стальной штифт - Система закрытия на защелке - 100% антикоррозийный - Высококачественное литье - Трехосевой датчик движения и подъема - Ключ и цилиндр максимальной безопасности

KS6 SERIES

ALARM DISC LOCK

SECURITY RATING

1 2 3 4 5 6 7 8 9 10



INCLUDES:



CODE	COLOR	MATERIAL	PIN SIZE	LOCK SYSTEM
KS6-BM	Brush Metal	Zinc-alloy	5,5mm	Push-Down Locking System
KS6-FG	Fluo Green	Zinc-alloy	5,5mm	Push-Down Locking System
KS6-FO	Fluo Orange	Zinc-alloy	5,5mm	Push-Down Locking System

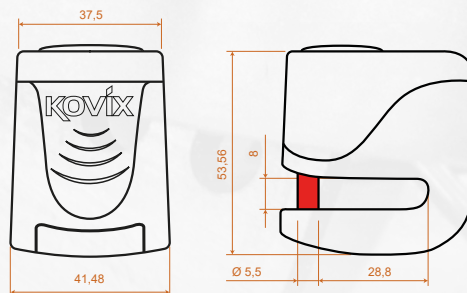

COLOURS

COLORI/FARBEN



EN	Alarm disc lock - 120dB alarm voice - Alarm module protected by zinc alloy - Weather-Proof Electronics - Lithium Long Battery life - Alarm Function selection USB Charge - Push-Down Locking system - 100% Preventing Rust - High quality cast - triaxial anti-lift motion sensor - high safety key and cylinder
IT	Blocca disco Allarmato - Sirena da 120 dB - Modulo allarmato protetto in lega di zinco - Modulo allarme con protezione pioggia - Batteria al litio lunga durata Selezione modalità allarme - Ricarica USB - Sistema chiusura a pressione - 100% anti Ruggine - Fusione di alta qualità Sensore di movimento e sollevamento triassiale - Chiave e cilindro di massima sicurezza
ES	Bloqueo disco de sonido / Alarmado - Sirena de 120 dB - Módulo de alarma protegido en aleación de zinc Módulo de alarma con protección contra la lluvia - Batería de litio de larga duración - Selección del modo de alarma - carga usb Sistema de cierre a presión - 100% antioxidante - Fundición de alta calidad - Sensor de movimiento y elevación triaxial- Llave y cilindro de máxima seguridad
DE	Alarmbremsscheibenschloss - 120dB Alarm Geräusch - Alarmmodul durch Zinklegierung geschützt - Wetter-Geschützte Elektronik Langlebige Lithium-Batterie - Alarmfunktions Auswahl - USB-Ladevorgang - Druck Verriegelungssystem - 100% Korrosions Beständig - Hochwertiger Guss Bewegungssensor und dreiaxialer Spezial - Schlüssel und Hochsicherheitszylinder
FR	Disclock Alarm - Système alarme à 120db - Module alarme protégée en alliage de zinc - électronique à l'épreuve des intempéries Lithium batteries longue durée - Sélection de la fonction d'allarme - charge USB - Push-Down Locking system - 100% anti-rouille - Usinage de haute qualité Capteur de mouvement triaxial - Verouillage de haute sécurité
RU	Предупреждение о блокировке диска - Сигнал тревоги 120 дБ - Модуль аварийной сигнализации защищен сплавом цинка Электроника устойчивая к атмосферным влияниям - Литиевая батарейка с продолжительным временем работы Выбор функции аварийной сигнализации - заряд USB - Система блокировки Push-Down - Предотвращение ржавления 100% Высокое качество отливки - Трехосевой датчик движения против подъема - Предохранительный ключ и цилиндр

KVS2-SS

TWO ATTACK POINTS DEFENSE
NO ALARM DISC LOCK

CERTIFIED:



SECURITY RATING

1 2 3 4 5 6 7 8 10

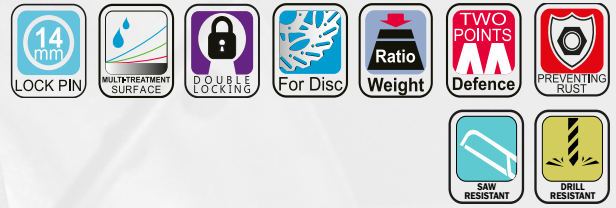

INCLUDES:



CODE	COLOR	MATERIAL	PIN SIZE	LOCK SYSTEM
KVS2-SS	● Brush Metal	Stainless steel	14mm	Double lock carbide pin

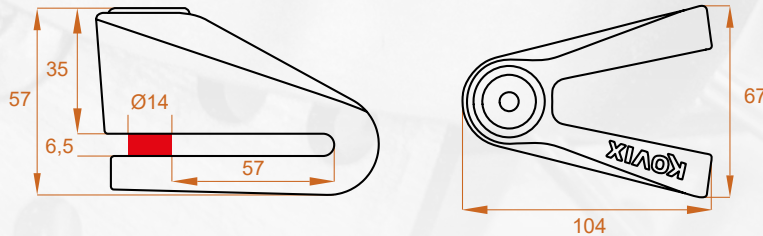

COLOURS COLORI/FARBEN

EN	Disc lock - Stainless steel key-barrel - Double locking carbide pin - Material: Stainless Steel - 100% Preventing Rust - Weight Ratio Design Two Attack Points Defense - Anti-corrosion Treatment - Ultra Resistant - high safety key and cylinder
IT	Blocca disco - Perno in acciaio inossidabile - Doppio serraggio del perno - Materiale: acciaio inossidabile - 100% anti Ruggine Massimo rapporto resistenza/peso - Protezione a due punti di ancoraggio - Trattamento anti corrosione - Super resistente Chiave e cilindro di massima sicurezza
ES	Bloqueo de disco - Pasador de acero inoxidable - Doble apriete del perno - Material: acero inoxidable - 100% antioxidante Máxima relación resistencia / peso - Protección de dos puntos - Tratamiento anticorrosión - Súper resistente Llave y cilindro de maxima seguridad
DE	Bremsscheibenschloss - Edelstahl-Schlüssel- Aufnahme - Doppelspann-Stift - Material: Edelstahl - 100% Korrosions Beständig Optimales Gewichts / Härteverhältnis - Schutz an zwei Ankerpunkten - Anti-Korrosions-Behandlung - Extrem Beständig - Schlüssel und Hochsicherheitszylinder
FR	Bloque Disque - Système alarme à 120db - Double mécanisme de verrouillage - Matériau: Acier inoxydable - 100% anti-rouille Conception ratio maximum résistance-poids - Double protection - Traitement anti-corrosion - Super résistant - Verouillage de haute sécurité
RU	дисковый замок - Цилиндр замка из нержавеющей стали - Двойной стопорный карбидный штифт - Материал: нержавеющая сталь Предотвращение ржавления 100% - Соотношение веса и сопротивления - Двухточечная защита Антикоррозийная обработка - Ультрстойкий - Предохранительный ключ и цилиндр

KV22 SERIES

TWO ATTACK POINTS DEFENSE
NO ALARM DISC LOCK

SECURITY RATING

1 2 3 4 5 6 7 8 9 10

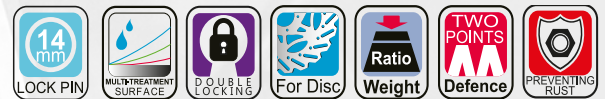

INCLUDES:



CODE	COLOR	MATERIAL	PIN SIZE	LOCK SYSTEM
KVZ2-BM	Brush Metal	Zinc-alloy	14mm	Double lock carbide pin
KVZ2-FG	Fluo Green	Zinc-alloy	14mm	Double lock carbide pin
KVZ2-FO	Fluo Orange	Zinc-alloy	14mm	Double lock carbide pin

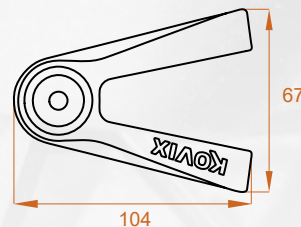
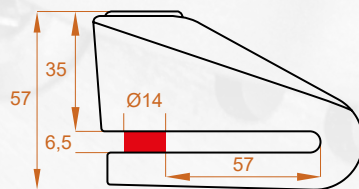

COLOURS

COLORI/FARBEN



EN

Disc lock - Stainless steel key-barrel - Double locking carbide pin - Material: Zinc alloy - 100% Preventing Rust - Weight Ratio Design
Two Attack Points Defense - Anti-corrosion Treatment - Ultra Resistant - high safety key and cylinder

IT

Blocca disco - Perno in acciaio inossidabile - Doppio serraggio del perno - Materiale: Lega di zinco - 100% anti Ruggine
Massimo rapporto resistenza/peso - Protezione a due punti di ancoraggio - Trattamento anti corrosione - Super resistente
Chiave e cilindro di massima sicurezza

ES

Bloqueo de disco - Pasador de acero inoxidable - Doble apriete del perno - Material: aleación de zinc - 100% antioxidante
Máxima relación resistencia / peso - Protección de dos puntos - Tratamiento anticorrosión - Súper resistente
Llave y cilindro de máxima seguridad

DE

Bremsscheibenschloss - Edelstahl-Schlüssel- Aufnahme - Doppelspann-Stift - Material: Zin-legierung - 100% Korrosions Beständig
Optimales Gewichts / Härteverhältnis - Schutz an zwei Ankerpunkten - Anti-Korrosions-Behandlung - Extrem Beständig - Schlüssel und Hochsicherheitszylinder

FR

Bloque Disque - Système alarme à 120db - Double mécanisme de verrouillage - Matériau: Zinc alliage - 100% anti-rouille
Conception ratio maximum résistance-poids - Double protection - Traitement anti-corrosion - Super résistant - Verouillage de haute sécurité

RU

дисковый замок - Цилиндр замка из нержавеющей стали - Двойной стопорный карбидный штифт - Материал: сплав цинка
Предотвращение ржавления 100% - Соотношение веса и сопротивления - Двухточечная защита
Антикоррозийная обработка - Ультрстойкий - Предохранительный ключ и цилиндр

KV2 1 SERIES

TWO ATTACK POINTS DEFENSE
NO ALARM DISC LOCK

SECURITY RATING

1 2 3 4 5 6 7 8 9 10

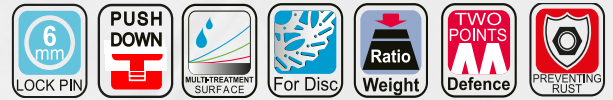

INCLUDES:



CODE	COLOR	MATERIAL	PIN SIZE	LOCK SYSTEM
KVZ1-BM	Stainless Steel	Zinc-alloy	6mm	Push-Down Locking System
KVZ1-FG	Fluo Green	Zinc-alloy	6mm	Push-Down Locking System

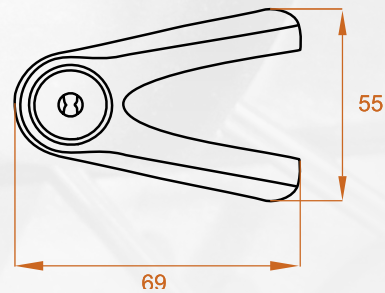
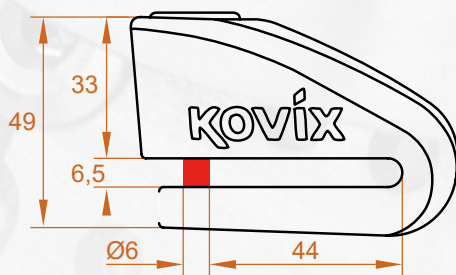

COLOURS

COLORI/FARBEN



EN Disc lock - Stainless steel key-barrel - Push-Down Locking system - Material: Zinc Alloy - 100% Preventing Rust - Weight Ratio Design
Two Attack Points Defense - high safety key and cylinder

IT Blocca disco - Perno in acciaio inossidabile - Sistema chiusura a pressione - Materiale: Lega di Zinco - 100% anti Ruggine
Massimo rapporto resistenza/peso - Protezione a due punti di ancoraggio - Chiave e cilindro di massima sicurezza

ES Bloqueo de disco - Perno de acero inoxidable - Sistema de cierre a presión - Material: aleación de zinc - 100% antioxidante
Máxima relación resistencia / peso - Protección de dos puntos - Llave y cilindro de máxima seguridad

DE Bremsscheibenschloss - Edelstahl-Schlüssel- Aufnahme - Druck Verriegelungssystem - Material: Zink-Legierung - 100% Korrosions Beständig
Optimales Gewichts / Härteverhältnis - Schutz an zwei Ankerpunkten - Schlüssel und Hochsicherheitszylinder

FR Bloque Disque - Système alarme à 120db - Double mécanisme de verrouillage - Matériau: Zinc alliage - 100% anti-rouille
Conception ratio maximum résistance-poids - Double protection - Verouillage de haute sécurité

RU дисковый замок - Цилиндр замка из нержавеющей стали - Система блокировки Push-Down - Материал: сплав цинка - Предотвращение ржавения 100%
- Соотношение веса и сопротивления - Двухточечная защита - Предохранительный ключ и цилиндр

KNN6/CB



SECURITY RATING

1 2 3 4 5 6 7 8 9 10



INCLUDES:



CODE	COLOR	MATERIAL	PIN SIZE	LOCK SYSTEM
KNN6-FG	 Fluo Green	Manganese	6mm	Push-Down Locking System

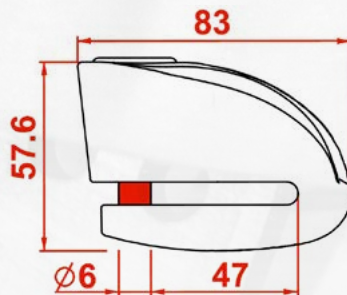

COLOURS

COLORI/FARBEN



EN	Manganese alloy module Stainless steel pin - Snap-lock closure system - 100% rust-free High-quality casting - Maximum security key and cylinder - Two copies of keys
IT	Modulo in lega di manganese Perno in acciaio inossidabile - Sistema di chiusura a pressione - 100% anti ruggine Fusione di alta qualità - Chiave e cilindro di massima sicurezza - Due copie di chiavi
ES	Módulo de aleación de manganeso Pasador de acero inoxidable - Sistema de cierre de presión - 100% sin óxido Fundición de alta calidad - Llave y cilindro de máxima seguridad - Dos copias de llaves
DE	Manganlegierungsmodul Edelstahlpfosten - Snap-Lock-Verschlussystem - 100% rostfrei Hochwertige Gießerei - Maximale Sicherheitsschlüssel und -zylinder - Zwei Schlüsselkopien
FR	Module en alliage de manganèse Broche en acier inoxydable - Système de fermeture à pression - 100% antirouille Coulée de haute qualité - Clé et cylindre de sécurité maximale - Deux copies de clés
RU	Модуль из марганцевого сплава Стальной штифт - Система закрытия на защелке - 100% антикоррозионный Высококачественное литье - Ключ и цилиндр максимальной безопасности - Два ключа

KN 1 SERIES

MINI DISC LOCK

SECURITY RATING

1 2 3 4 5 6 7 8 9 10



INCLUDES:



CODE	COLOR	MATERIAL	PIN SIZE	LOCK SYSTEM
KN1-BM	Brush metal	Zinc-alloy	5,5mm	Push-Down Locking System
KN1-FG	Fluo Green	Zinc-alloy	5,5mm	Push-Down Locking System

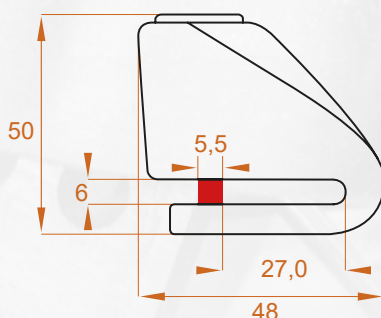

COLOURS COLORI/FARBEN



EN

Disc lock - Stainless steel key-barrel - Push-Down Locking system - Material: Zinc Alloy - 100% Preventing Rust - Weight Ration Design high safety key and cylinder

IT

Blocca disco - Perno in acciaio inossidabile - Sistema chiusura a pressione - Materiale: Lega di Zinco - 100% anti Ruggine
Massimo rapporto resistenza/peso - Chiave e cilindro di massima sicurezza

ES

Bloqueo de disco - Perno de acero inoxidable - Sistema de cierre a presión - Material: aleación de zinc - 100% antioxidante
Máxima relación resistencia / peso - Llave y cilindro de máxima seguridad

DE

Bremsscheibenschloss - Edelstahl-Schlüssel- Aufnahme - Druck Verriegelungssystem - Material: Zink-Legierung - 100% Korrosions Beständig
Optimales Gewichts / Härteverhältnis - Schlüssel und Hochsicherheitszylinder

FR

Bloque Disque - Système alarme à 120db - Double mécanisme de verrouillage - Matériau: Zinc alliage - 100% anti-rouille
Conception ratio maximum résistance-poids - Verouillage de haute sécurité

RU

дисковый замок - Цилиндр замка из нержавеющей стали - Система блокировки Push-Down - Материал: сплав цинка - Предотвращение ржавления 100%
Соотношение веса и сопротивления - Предохранительный ключ и цилиндр

KNN 1 SERIES

MINI DISC LOCK

SECURITY RATING

1 2 3 4 5 6 7 8 9 10



INCLUDES:



CODE	COLOR	MATERIAL	PIN SIZE	LOCK SYSTEM
KNN1/CB-FG	● Fluo Green	Manganese	5,5mm	Push-Down Locking System

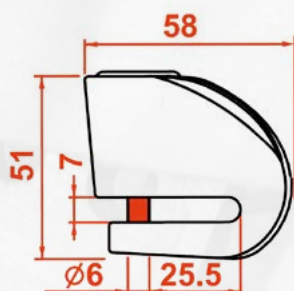

COLOURS

COLORI/FARBEN



EN	Disc lock - Manganese steel - Snap-lock closure system 360° anti-corrosion cover - 6mm pin Two copies of keys
IT	Blocca disco - Acciaio al manganese - Sistema di chiusura a pressione Copertura anticorrosione a 360° - Perno da 6mm Due copie di chiavi
ES	Bloqueo de disco - Acero de manganese - Sistema de cierre de presión Cobertura anticorrosión de 360° - Pasador de 6mm Dos copias de llaves
DE	Scheibenbremschloss - Manganstahl - Snap-Lock-Verschlussystem 360°-Antikorrosionsabdeckung - 6-mm-Stift Zwei Schlüsselkopien
FR	Bloque-disque - Acier au manganèse - Système de fermeture à pression Couverture anticorrosion à 360° - Broche de 6 mm Deux copies de clés
RU	Замок диска - Марганцевая сталь - Система закрытия на защелке 360° антикоррозионное покрытие - Штифт 6 мм Два ключа

KFQ SERIES

FOLDABLE LOCK

SECURITY RATING

1 2 3 4 5 6 7 8 9 10



INCLUDES:



CODE	COLOR	MATERIAL	PIN SIZE	LOCK SYSTEM
KFQ-FO	 Fluo Orange	Manganese	18mm	Push-Down Locking System

COLOURS

COLORI/FARBEN



EN	Perfect for bikes and scooters - 120db sound alarm - 360° motion sensor and alarm Selectable alarm function ON/OFF - 3m thick bars - Extra soft coating to prevent paint damage Manganese steel lock body - High resistance to bolt cutters and drills - Disc cylinder
IT	Perfetto per Bici e Scooters - Allarme acustico da 120db - Sensore di movimento e allarme a 360° Selezione della funzione di allarme ON/OFF - Barre spesse 3m, - Rivestimento extra morbido per evitare danni alla vernice Corpo della serratura in acciaio al manganese - Elevata resistenza al grimaldello e al trapano - Cilindro a disco
ES	Perfecto para bicicletas y scooters - Alarma de sonido de 120db - Sensor de movimiento y alarma de 360° Selección de función de alarma ON/OFF - Barras de 3m de grosor - Recubrimiento extra suave para evitar daños en la pintura Cuerpo de cerradura de acero de manganese - Alta resistencia a los cortadores de pernos y taladros - Cilindro de disco
DE	Perfekt für Fahrräder und Roller - 120db-Sound-Alarm - 360°-Bewegungssensor und -Alarm Wählbare Alarmfunktion ON/OFF - 3m dicke Stäbe - Extra weiche Beschichtung zum Schutz vor Lackbeschädigungen Manganstahl-Schlosskörper - Hohe Widerstandsfähigkeit gegen Bolzenschneider und Bohrer - Scheibenzyylinder
FR	Parfait pour les vélos et les scooters - Alarme sonore de 120db - Capteur de mouvement et alarme à 360° Fonction d'alarme sélectionnable ON/OFF - Barres de 3m d'épaisseur - Revêtement extra doux pour éviter les dommages de peinture Corps de serrure en acier au manganèse - Haute résistance aux coupe-boulons et aux forets - Cylindre à disque
RU	Идеально подходит для велосипедов и скутеров - Звуковая сигнализация 120 дБ - Датчик движения и сигнализация на 360° Выборочная функция сигнализации ВКЛ./ВЫКЛ. - Стальные прутья толщиной 3 м - Дополнительное мягкое покрытие для предотвращения повреждения краски - Корпус замка из марганцевой стали - Высокая устойчивость к резцам и сверлам - Дисковый цилиндр

KHL SERIES

GRIP LOCK ALARM



SECURITY RATING

1 2 3 4 5 6 7 8 9 10



INCLUDES:



CODE	COLOR	MATERIAL	LOCK SYSTEM
KHL-B	● Blue	Zinc-alloy	Double Lock System
KHL-R	● Red	Zinc-alloy	Double Lock System

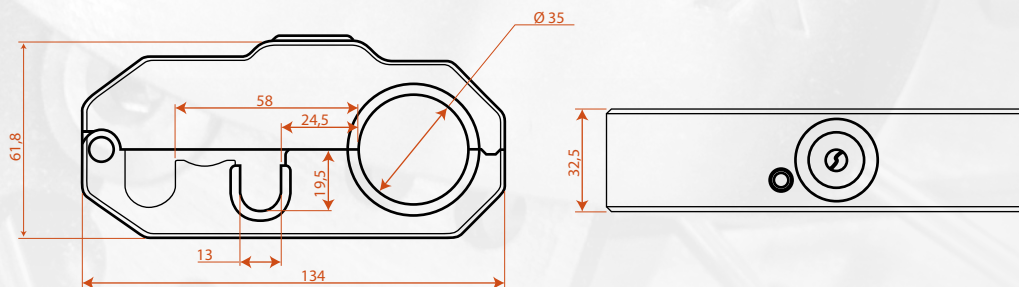

COLOURS

COLORI/FARBEN



EN	Brake lever lock - 120dB alarm voice - Alarm module protected by zinc alloy - Weather-Proof Electronics - Lithium Long Battery life - Alarm Function selection Stainless steel key-barrel - Push-Down Locking system - 100% Preventing Rust - High quality cast - triaxial anti-lift motion sensor - high safety key and cylinder
IT	Blocco leva del freno Allarmato - Sirena da 120 dB - Modulo allarmato protetto in lega di zinco - Modulo allarme con protezione pioggia - Batteria al litio lunga durata - Selezione modalità allarme - Perno in acciaio inossidabile - Sistema chiusura a pressione - 100% anti Ruggine - Fusione di alta qualità Sensore di movimento e sollevamento triassiale - Chiave e cilindro di massima sicurezza
ES	Bloqueo de palanca de freno - Sirena de 120 dB - Módulo de alarma protegido en aleación de zinc - Módulo de alarma con protección contra la lluvia Batería de litio de larga duración - Selección del modo de alarma - Perno de acero inoxidable - Sistema de cierre a presión - 100% antioxidante Fundición de alta calidad - Llave y cilindro de máxima seguridad
DE	Alarmbremshebelschloss - 120dB Alarm Geräusch - Alarmmodul durch Zinklegierung geschützt - Wetter-Geschützte Elektronik - Langlebige Lithium-Batterie Alarmfunktions Auswahl - Edelstahl-Schlüssel- Aufnahme - Druck Verriegelungssystem - 100% Korrosions Beständig - Hochwertiger Guss Bewegungssensor und dreiaxiger Spezial - Schlüssel und Hochsicherheitszylinder
FR	Verrouillage du levier de frein - Système alarme à 120db - Module alarme protégée en alliage de zinc - électronique à l'épreuve des intempéries Lithium batteries longue durée - Sélection de la fonction d'allarme - Mécanisme de verrouillage pin en acier inoxydable - Push-Down serrure - 100% anti-rouille Usinage de haute qualité - Capteur de mouvement triaxial - Capteur de mouvement triaxial"
RU	блокировка рычага тормоза - Сигнал тревоги 120 дБ - Модуль аварийной сигнализации защищен сплавом цинка - Электроника устойчивая к атмосферным влияниям - Литиевая батарейка с продолжительным временем работы - Выбор функции аварийной сигнализации Цилиндр замка из нержавеющей стали - Система блокировки Push-Down - Предотвращение ржавения 100% Высокое качество отливки - Трехосевой датчик движения против подъема - Предохранительный ключ и цилиндр

KWL

ALARMED CABLE LOCK

SECURITY RATING

1 2 3 4 5 6 7 8 9 10

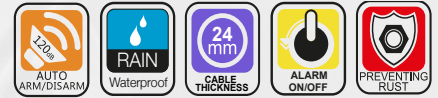

SOLID STEEL

INCLUDES:



CODE	COLOR	MATERIAL	SIZE
KWL24-110BK	● Black	Steel	Ø 24 mm X L 1100mm

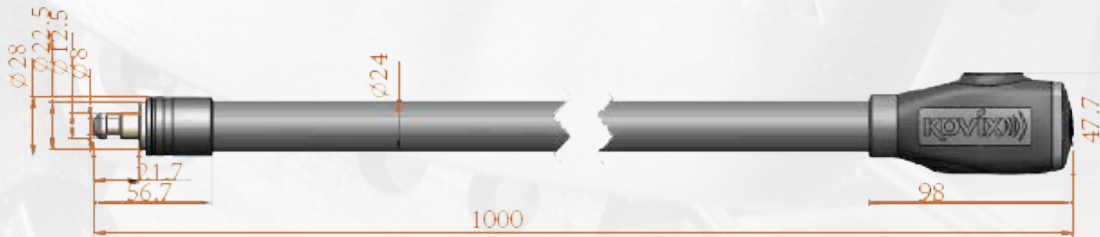

COLOURS

COLORI/FARBEN



EN	Alarmed cable - Material: Hardened Steel - 100% Preventing Rust - Solid Steel Lock Body - Ultra Strong U-bar - Anti-corrosion Treatment Ultra Resistant - Ultra strong locking pin - high safety key and cylinder
IT	Cavo allarmato - Materiale: Acciaio temperato - 100% anti Ruggine - Corpo in acciaio rinforzato - Anello in acciaio super duro - Trattamento anti corrosione Super resistente - Ultra strong locking pin - Chiave e cilindro di massima sicurezza
ES	Cable alarmado - Material: acero inoxidable - 100% antioxidante - Cuerpo de acero reforzado - Anillo de acero super duro - Tratamiento anticorrosión Súper resistente - perno de bloqueo ultra fuerte - Llave y cilindro de maxima seguridad
DE	Alarmiertes Kabel - Material: gehärteter Stahl - 100% Korrosions Beständig - Massive Stahl Schlosskörper - Ultra starkes U-Schloß Anti-Korrosions-Behandlung - Extrem Beständig - Ultra strong locking pin - Schlüssel und Hochsicherheitszylinder
FR	Câble alarmé - Matériau: Acier cémenté - 100% anti-rouille - Ance réversible en acier trempé - Corps en acier trempé - Traitement anti-corrosion Super résistant - Goupille de verrouillage ultra solide - Verouillage de haute sécurité
RU	Тревожный кабель - Материал: Закаленная сталь - Предотвращение ржавения 100% - Твердый стальной корпус замка - Ультрпрочный швеллер Антикоррозийная обработка - Ультрстойкий - сверхпрочный стопорный штифт - Предохранительный ключ и цилиндр

KCL SERIES

ALARM CHAIN LOCK

SECURITY RATING

1 2 3 4 5 6 7 8 9 10



KCL10-150



KCL8-120



SOLID STEEL

INCLUDES:



CODE	COLOR	MATERIAL	SIZE
KCL10-150	● Black	Hardened steel	Ø 10 mm X L 1500mm
KCL8-120	● Black	Hardened steel	Ø 8 mm X L 1200mm

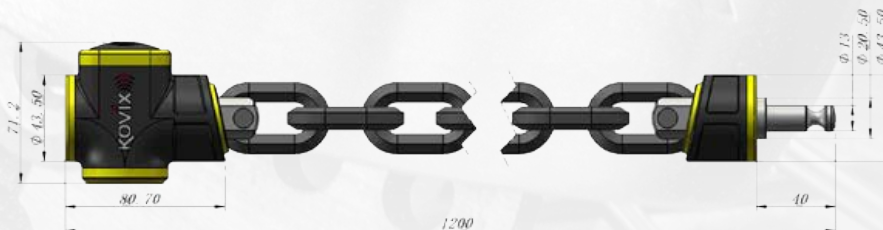

COLOURS

COLORI/FARBEN



EN	Alarmed strong chain - 120dB alarm voice - Stainless steel body - Weather-Proof Electronics* - Litium Long battery life - 100% Preventing Rust Ultra Resistant - high safety key and cylinder - Fabric cover
IT	Catena allarmata super resistente - Sirena da 120dB - Corpo d'acciaio inossidabile - Modulo allarme con protezione pioggia* - Batteria al litio lunga durata 100% anti Ruggine - Super resistente - Chiave e cilindro di massima sicurezza - Copertura in tessuto
ES	Cadena fuerte alarmada - Sirena de 120dB - Cuerpo de acero inoxidable - Electrónica resistente a la intemperie* - Batería de litio de larga duración Prevención del óxido al 100% - Ultra resistente - Llave y cilindro de alta seguridad - Funda de tela
DE	Starke hitzebeständige Alarmerkette - 120dB Alarm Geräusch - Gehäuse aus Edelstahl - Wetter-Geschützte Elektronik* - Langlebige Lithium-Batterie 100% Korrosions Beständig - Extrem Beständig - Schlüssel und Hochsicherheitszylinder - Stoffbezug
FR	Chaîne d'alarme solide - Système alarme 120dB - Corps en acier inoxydable - Électronique résistante aux intempéries* Litium Longue durée de vie de la batterie - 100% empêchant la rouille - Ultra résistant - Clé et cylindre de haute sécurité - Housse en tissu
RU	Супер стойкая сигнальная цепь - Сигнал тревоги 120 дБ - Корпус из нержавеющей стали - Электроника устойчивая к атмосферным влияниям* - Литиевая батарейка с продолжительным временем работы - Предотвращение ржавления 100% - Ультрстойкий Предохранительный ключ и цилиндр - Полотняная обшивка

KCK 10-150

CHAIN WITH PADLOCK

SECURITY RATING

1 2 3 4 5 6 7 8 9 10



INCLUDES:



CODE

KCK10-150

COLOR

• Black

MATERIAL

Stainless steel

SIZE

Ø 10 mm X L 1500mm

COLOURS

COLORI/FARBEN



EN

10mm diameter chain - Length 1500mm - With plastic-coated security u-lock and slot closure to access the key
Two keys - Chain covered with protective nylon stocking
Distributed in cardboard crates containing 5 units, crate dimensions 42cm x 18cm x 20cm, each weighing 16kg

IT

Catena da 10mm di diametro - Lunghezza 1500mm - Lucchetto di sicurezza rivestito in materiale plastico e chiusura della fessura per la chiave
Il sistema verrà corredato di due chiavi - Catena rivestita con calza protettiva in nylon
Distribuito in cartoni da 5pz di dimensione 42cm x 18cm x 20cm del peso di 16Kg cad.

ES

Cadena de 10 mm de diámetro - Longitud 1500 mm - Con cerradura de seguridad recubierta de plástico y cierre con ranura para acceder a la llave - Dos llaves - Cadena cubierta con fundas protectoras de nylon - Distribuida en cajas de cartón que contienen 5 unidades, dimensiones de caja de 42 cm x 18 cm x 20 cm, cada una con un peso de 16 kg

DE

Kette mit 10 mm Durchmesser - Länge 1500mm - Mit kunststoffbeschichtetem Sicherheitsschloss und Schlitzverschluss für den Zugriff auf den Schlüssel
Das System wird mit zwei Schlüsseln geliefert - Kette mit Nylonschutzstrumpf überzogen
In Kartons von 5 Stück Größe verteilt - 42 cm x 18 cm x 20 cm mit einem Gewicht von jeweils 16 kg

FR

Chaîne diamètre 10mm - Longueur 1500mm - Avec serrure de sécurité en plastique et fermeture à fente pour accéder à la clé - Deux clés
Chaîne recouverte de bas de protection en nylon - Distribué dans des caisses en carton contenant 5 unités, dimensions de la caisse 42 cm x 18 cm x 20 cm, pesant chacune 16 kg

RU

Цепь диаметром 10 мм - Длина 1500 мм - С пластиковым покрытием, защищенным U-образным замком и прорезью для доступа к ключу
Два ключа - Цепь покрыта защитным нейлоновым чулком - Распределены в картонных ящиках по 5 штук, размеры ящиков 42 см x 18 см x 20 см каждый весом 16 кг

KZA/KZI/KSA

SECURITY CABLES

KSA-150

Security Cable for KAL10 -
KAL14



KAL Series disc lock not included

KZA-150

Security Cable for KD6



KD6 Series disc lock not included

KZI-150

Security Cable for KAL6-BM



KAL6-BM disc lock not included



EN

Security Cable - 1500mm length x 8mm diameter

IT

Cavo di sicurezza - 1500mm lunghezza x 8mm diametro

ES

Cable de seguridad - 1500 mm largo x 8 mm de diámetro

DE

Sicherheitskabel - 1500 mm Länge x 8 mm Durchmesser

FR

Câble de sécurité - 1500 mm de longueur x 8 mm de diamètre

RU

Защитный кабель - 1500 мм длина x 8 мм диаметр

KC002FO

Reminder Cable

Color:

Fluo Orange

KC002FG

Reminder Cable

Color:

Fluo Green

KTL-R14

Fixing system for KTL14



KTL-R16

Fixing system for KTL16



KH-NX10

KNX Lock holder



KC005

Lithium long life Battery



KH-V17

KVX, KV, KAL Lock holder



KOVIX BAG

KH-V9

KAL 6 Lock holder



KHL BAG

KC003

KD6 Lock holder



DISPLAY SERIES

EXPO PRODUCTS



EXP-KOVIX

Shop stand

System

Overall size 64cm x 30cm x 170cm

Base size 64cm x 22cm x 30cm

Tube frame diameter 6cm



KBA

Disc locks stand





regional dealer

European distributor: ZEAT srl - Via Galvani,9 - 35030 Selvazzano Dentro (Padova) Italy - Phone: +39 049 631930 - E-mail: info@kovix-security.eu
www.kovix-security.eu - www.zeatmoto.com